



# SED OPS-810R

## User Manual







---

## Contents

<b>Warning</b>	.....	<b>- 7 -</b>
<b>1</b>	<b>Getting Started</b> .....	<b>- 8 -</b>
1.1	Safety Precautions .....	- 8 -
1.2	Specific Absorption Rate Information .....	- 11 -
1.3	Environmental care .....	- 12 -
1.4	Disposal of your old product .....	- 13 -
<b>2</b>	<b>OPS-810R Introduction</b> .....	<b>- 16 -</b>
2.1	Overview .....	- 16 -
2.2	OPS Structure .....	- 16 -
2.3	Battery Management .....	- 19 -
2.4	Power-On and Power-Off .....	- 21 -
2.5	Keys and Symbols .....	- 22 -
2.6	Settings .....	- 25 -
2.7	OPS Holder .....	- 26 -
2.8	Clip Operations for OPS .....	- 36 -

<b>3</b>	<b>Conventional Call Service (ASD)</b> .....	<b>- 38 -</b>
3.1	Railway Internal Fixed Telephone Network (Basa Network) .....	- 38 -
3.2	Call Initiation .....	- 38 -
3.3	Answering a Single Call .....	- 39 -
3.4	Terminating a Single Call .....	- 39 -
3.5	Storing a Phone Number .....	- 39 -
3.6	Call Waiting, Call Holding, and Conference Call Initiation .....	- 42 -
<b>4</b>	<b>Shunting without Use of Wireless Shunting Group</b> .....	<b>- 45 -</b>
4.1	Using Train Number/Shunting Train Number for Registration .....	- 45 -
4.2	Call Number When Train Number Is Used for Shunting .....	- 50 -
4.3	Call Number When Shunting Number Is Used for Shunting in Area Shunting Service .....	- 52 -
4.4	Call Initiation .....	- 53 -
4.5	Calling a Fixed Number .....	- 54 -
4.6	Conference Call .....	- 54 -
4.7	Exiting Train Number/Shunting Train Number .....	- 55 -
4.8	Public Group Call .....	- 57 -

4.9	Emergency Call .....	- 58 -
<b>5</b>	<b>Shunting Group Shunting of OPS .....</b>	<b>- 63 -</b>
5.1	Enabling GSM-R Wireless Shunting Function on the OPS.....	- 63 -
5.2	Initiating Group Call in GSM-R System.....	- 67 -
5.3	Call in Particular Wireless Shunting Group.....	- 70 -
5.4	Switching Shunting Area .....	- 71 -
5.5	Dedicated Shunting Group .....	- 71 -
5.5.1	Registration in Dedicated Shunting Group.....	- 71 -
5.5.2	Initiating/Terminating a Call in Dedicated Wireless Shunting Group ...	- 74 -
5.5.3	Exiting Shunting Group .....	- 74 -
5.5.4	Ending Shunting Group.....	- 74 -
5.5.5	Fixed User Voice Call.....	- 74 -
5.6	Switching Wireless Shunting Group .....	- 76 -
5.7	Emergency Call When Shunting Is Performed in Dedicated Shunting Group..	- 76 -
5.7.1	Initiating Wireless Shunting Emergency Call.....	- 76 -
5.7.2	Answering and Terminating Shunting Emergency Call.....	- 78 -
5.8	Ending Shunting.....	- 78 -

---

<b>6</b>	<b>OPS in Nationwide Roaming</b> .....	<b>- 80 -</b>
6.1	Features in Roaming Networks.....	- 80 -
6.2	Switching OPS to T-Mobile D Roaming Network.....	- 82 -
6.3	Returning to GSM-R Network.....	- 87 -
<b>7</b>	<b>Independent Individual Operation Emergency Alarm</b> .....	<b>- 88 -</b>
7.1	Working Alone Call Mode.....	- 88 -
7.2	Emergency Reporting Configured based on Personal Requirements.....	- 88 -
7.3	Enabling Working Alone Function of the OPS.....	- 90 -
7.4	Disabling Working Alone Function of the OPS.....	- 92 -
7.5	Enabling Independent Individual Operation Emergency Alarm.....	- 92 -
<b>8</b>	<b>COUNT DOWN Function Introduction</b> .....	<b>- 94 -</b>
<b>9</b>	<b>Tools</b> .....	<b>- 94 -</b>
9.1	RF Monitoring.....	- 94 -
9.2	Bluetooth.....	- 94 -
9.3	Cell forcing.....	- 95 -
9.4	Cell lock.....	- 95 -

---

<b>10</b>	<b>Reference Information .....</b>	<b>- 96 -</b>
10.1	Access Password .....	- 96 -
10.2	Battery use .....	- 97 -
10.3	Precautions for battery use .....	- 97 -
10.4	CAUTION .....	- 98 -
10.5	Careful Maintenance .....	- 98 -
10.6	Glossary .....	- 99 -
10.7	Troubleshooting .....	- 103 -



**Warning**

Copyright © 2015

Shenzhen SED Wireless Communication Technology Co., Ltd.

All rights reserved.

No part of this manual may be reproduced in any form or by any means without the written consent of Shenzhen SED Wireless Communication Technology Co., Ltd.

This manual describes the features and functions of the SED OPS-810R handset only. Due to product version upgrades or other reasons, this manual is subject to change without notice. Unless otherwise stated, this manual serves only as an instruction manual. Any statements, information, and suggestions in this manual do not constitute a warranty of any kind, explicit or implied.

Version: D

## 1 Getting Started

The wireless device described in this manual applies to GSM-R networks. For more information about applicable networks, consult your service provider.

Your handset is a low-power radio transmitter and receiver. It receives and transmits radio-frequency signals during use. When you use the handset for communication, the system for call processing controls the transmitted power level of your handset. The maximum operating temperature of your handheld is 40°C.

### 1.1 Safety Precautions



Read the following safety precautions to avoid danger and comply with the law.

#### **Children:**

Store your handset in a safe place beyond the reach of children. Do not let children play with the handset or its accessories. Improper use by children may damage the handset or its accessories and cause injury. Children may also swallow removable parts of the handset, such as the SIM card and battery.

#### **Environmental protection:**

Do not dispose of the handset or electronic accessories, such as the battery charger, headphone, and battery, with organic waste. Observe local laws, and recycle all parts of the product.

#### **Traffic safety:**

Strictly observe local laws and regulations governing the usage of mobile handsets when driving. If local law allows you to use a handset while driving a vehicle, follow these instructions:

- Focus on steering the vehicle and pay attention to traffic;
- Use the headphone to make calls;
- If driving conditions are not good, stop the vehicle at the roadside before using the handset.

Do not place your handset above or near the airbag when it is unfolded as the expanded airbag generates a strong external force, and may cause the handset to injure the user.

Consult your automobile manufacturer to ensure that the electronic devices used in your vehicle are not affected by radio waves.

**Public places:**

Switch off your handset in public places if the use of handsets is forbidden.

**Airplanes:**

Comply with the law. The use of handsets on airplane interferes with flight controls. Switch off your handset before boarding a plane.

**Near an explosion site:**

To avoid interfering with demolition works, switch off your handset at demolition sites or in places displaying notices to switch off bi-directional radios. Observe rules and regulations.

**Near dangerous articles:**

Switch off your handset at gas stations or near dangerous substances, such as fuel and chemical reagents.

**Hospitals:**

Switch off your handheld in hospitals and near medical devices marked with signs forbidding the use of handhelds.

**Pacemakers:**

Keep a distance of at least 15 cm between the handset in standby state and a pacemaker.

Do not place the handset in a chest pocket.

Use the ear the furthest away from the pacemaker to answer calls.

Switch off your handset if you feel uncomfortable.

### **Hearing aids:**

If you use a hearing aid, consult your doctor and hearing aid manufacturer to check if your hearing aid is sensitive to handset interference.

### **Interference:**

All handsets may suffer interference, thus affecting performance.

### **Headphone and batteries:**

Using the receivers, headphones, speakers or earpieces at high volume can result in permanent hearing loss.

Please check the model of charger firstly before using with this mobile phone. This mobile phone is intended to use when supplied with power from charger HKA00605008-3B .

Only use batteries, chargers approved by Shenzhen SED Wireless Communication Technology Co., Ltd. with the particular model. Using any other types of batteries, chargers will invalidate the approval or warranty, and may be dangerous. Please grasp and pull the plug, not the cord when you disconnect the power cord of any enhancement. For pluggable equipment, the socket-outlet shall be installed near the equipment and shall be easily accessible.

**Note:** *When inserting the battery charger to charge the handset, do not remove the battery from the handset, or insert the battery charger into a handset without a battery. Doing so may damage the handset.*

Do not short circuit the battery. If a metal object contacts the exposed electrode of the battery, short-circuiting occurs, which can cause damage or injury. To prevent accidental leaks, store charged

batteries properly. Be careful if you place a battery in your pocket, wallet or bag with other metal items.

**Emergency calls:**

Ensure that the handset is switched on, and is in a service area. Dial the emergency number in standby state. Then, press the call key. Inform the operator of your location. Do not end the call without permission.

**Temperature range:**

The temperature range for using the phone is  $-20^{\circ}\text{C}$  to  $+55^{\circ}\text{C}$  and the ambient temperature for adapter operation is  $0^{\circ}\text{C}$  to  $+40^{\circ}\text{C}$  (20% Relative Humidity to 80% Relative Humidity).

**Voltage range:**

The voltage range of the phone battery is 3.6V – 4.2 V.

**Altitude:**

The phone is proposed to be used at an altitude from -100m to 2500m as a minimum.

## 1.2 Specific Absorption Rate Information

THIS PRODUCT MEETS THE INTERNATIONAL RECOMMENDATIONS FOR EXPOSURE TO RADIO WAVES

Your handset is a radio transmitter and receiver. It is designed and manufactured not to exceed the limits for exposure to radio frequency(RF) energy defined by the international standards. These recommendations have been established by the International Commission on Non-ionizing Radiation Protection(ICNIRP) that forecasts a substantial safety margin for assuring the protection for all persons, regardless of age and health. The exposure recommendations for handset use a measurement unit known as the Specific Absorption Rate (SAR).The SAR limit recommended by the

ICNIRP for the handset used by the general public is **2.0W/kg averaged over ten grams of tissue**. While there may be differences between the SAR levels of various handsets and at various positions, they all meet the international protection standards for exposure to radio waves. The highest SAR value for the OPS-810R handset when tested for compliance against the standard was 0.668 W/kg for ICNIRP recommendation.

Tests for SAR have been conducted to use recommended operating positions with the handset transmitting at its highest certified power level in all tested frequency bands. Although the SAR is determined at the highest certified power level, the actual SAR levels of the handset while operating are generally below the maximum SAR value. This is because the handset is designed to operate at multiple power levels so as to use only the power required to reach the network. In general, the closer you are to the base station antenna, the lower the power output.

For limiting the radio waves exposure, it is recommended to reduce the handset call duration or to use a headset. The purpose of those precautions is to take the handset away from the head and the body.

### 1.3 Environmental care

Remember to observe the local regulations regarding the disposal of the packaging materials, exhausted batteries and old handset and please promote their recycling. SED wireless has marked the battery and packaging with standard symbols designed to promote the recycling and appropriate disposal of your eventual waste.



The crossed-out dustbin signifies that the battery should not be disposed with the general household waste.



The packaging material with this label is recyclable.



The plastic material is recyclable (also identifies the type of plastic).

## **WEEE Marking :“Information to the Consumer”**

### **1.4 Disposal of your old product**

Your product is designed and manufactured with high quality materials and components, which can be recycled and reused.



When this crossed-out wheeled bin symbol is attached to a product, it means the product is covered by the European Directive 2002/96/EC.

Please inform yourself about the local separate collection system for electrical and electronic products.

 Please act according to your local rules and do not dispose your old products with the normal household waste. The correct disposal of your old product will help prevent potential negative consequences for the environment and human health.

This device may contain the commodities, technology or software subjected to export laws and regulations from the US and other countries. Diversion contrary to law is prohibited.

## **Declaration of Conformity**

We,

**Shenzhen SED Wireless Communication Technology Co., Ltd.**

**11/F, SED Science and Technology Building, Nanshan District,**

**Shenzhen 518000**

**China**

declare under our sole responsibility that the product

**SED OPS-810R**

R-GSM 900/GSM 1800

is in conformity with the following Standards:

SAFETY : IEC60950-1:2005(2nd Edition)

EN 60950-1:2006+A11:2009

HEALTH: EN 50360:2001

EN 62209-1:2006

EMC: EN 301 489-1 V1.8.1: 2008

EN 301 489-7 V1.3.1: 2005

SPECTRUM: EN 301 511 V9.0.2: 2003

We hereby declare that the above named product is in conformity with the essential requirements of Directive 1999/5/EC.

The Conformity assessment procedure referred to in Article 10 of Directive 1999/5/EC has been followed with the involvement of the following Notified Body(ies):

PHOENIX TESTLAB GmbH

Königswinkel 10

D-32825 Blomberg, Germany

The product is marked with the CE marking and Notified Body number according to the Directive 1999/5/EC:



CE 0700

**Date : 05 March 2012**

**Authorization:**

Signature :



Name : Frank HE

Position : Vice President

## 2 OPS-810R Introduction

### 2.1 Overview

OPS-810R is a product developed by Shenzhen SED Wireless Communication Technology Co., Ltd. The full name of this mobile device is SED OPS-810R, which is referred to as OPS in this manual. The OPS, with 2-watt transmit power, is used in digital GSM-R shunting systems. This device applies to non-conventional environments.

You can store a maximum of 100 SMSs and 1000 entries of phone numbers and names in the OPS. In addition, the OPS automatically stores the latest 20 call records, which are stored after the device is powered off.

### 2.2 OPS Structure

The following figure shows the keys on the device, from which you can learn the meanings of the keys and other settings of the OPS.

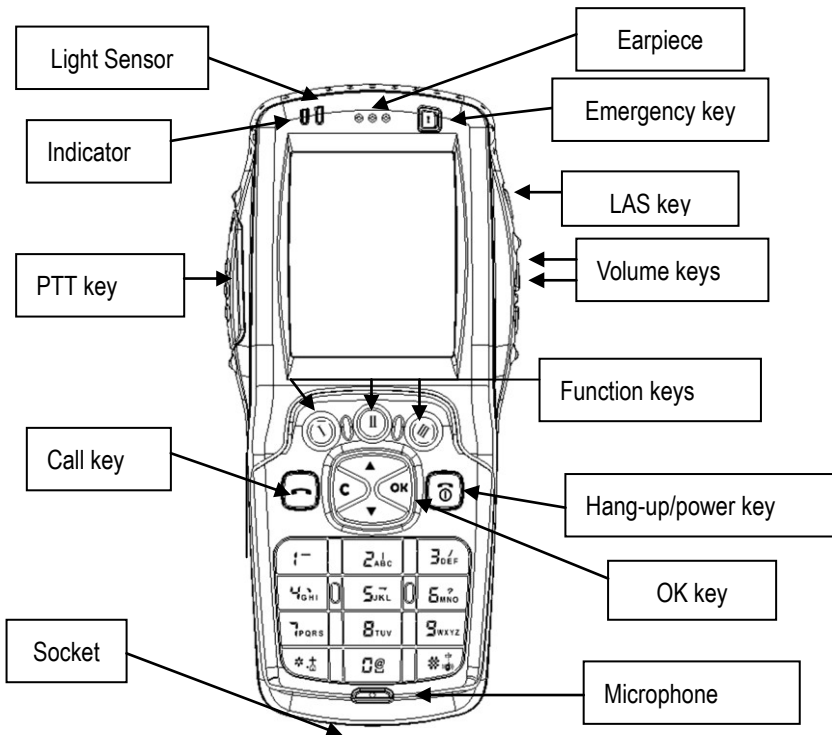

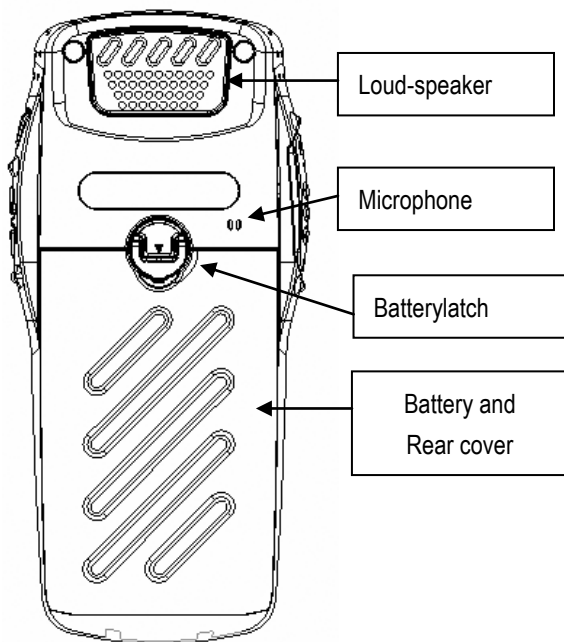

## **2.3 Battery Management**

Of the energy of the battery, 20% is used for point-to-point call (PtP Call), 60% is used for voice group call, and 20% is used for standby consumption. The battery can be used for up to 12 hours under temperatures between -10°C and 25°C.

The OPS can be charged using a desktop charger.

The OPS can be easily placed on a holder of the desktop charger.

If the OPS has not been used for a long time, you are advised to remove the battery.

You can view the charging status of the battery on the upper-right corner of the display.



Before the battery is used up, you can:

- Hear low-battery prompt voice repeatedly.
- Learn battery consumption information from the hollow blinking battery icon.

## 2.4 Power-On and Power-Off

Press & hold the power key for about two or three seconds to power on the OPS. Then, the vendor name (SED) appears upon power-on.



**Note:** If the above information is displayed on the screen, it indicates that the SIM card is not authorized for the railway emergency call. In this case, please hand over the faulty SIM card to relevant GSM-R department, and use a functioning SIM card instead.

To power off the OPS, press & hold the red power key  for about two or three seconds.

## 2.5 Keys and Symbols



is used to answer a call, enable a handfree mode, and redial a number.



is used to power on or off the OPS and terminal a call.



There are three function keys under the display.

The following uses examples for illustration:

The function key I (on the left) is used to log in for shunting operations. After the OPS is in the shunting mode, the function key III (on the right) is used to switch between shunting group.



The **OK** key is used to open the main menu.

In the train mode, the **III** key (on the right) is used to browse the phone book.

In the train mode, the **II** key (in the middle) is used to list the ongoing group call.

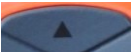
In the train mode, the  key is used to directly register a function ID.

In the train mode, the  key is used to open or close the Working Alone function.

The PTT key is on the left side. You can press the PTT key on the standby UI, the latest call is redialed. A call made in such a manner is automatically in handfree mode.

## Symbols

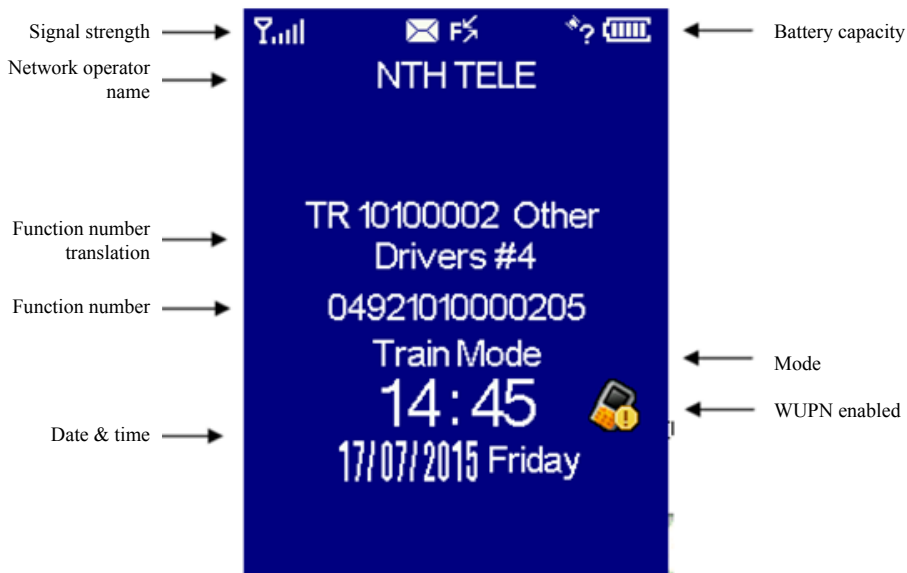

## 2.6 Settings

To open the **Settings** menu, press the **OK** key. Use the **OK** key to confirm your settings. In this menu, you can use other submenus for other settings, for example, Date/Time setting.



The keys on the right side are used to set the volume

The volume is set to 5 by default. You are allowed to modify the volume using the keys on the side panel (on the right) during a call.



During a call, you can press  to enable or disable the handfree mode.

**Note:**

*To enable the handfree mode, use this green key during a call.*

## 2.7 OPS Holder

Comfort for operation and security for carrying need to be considered for the OPS when a holder for the wireless device.

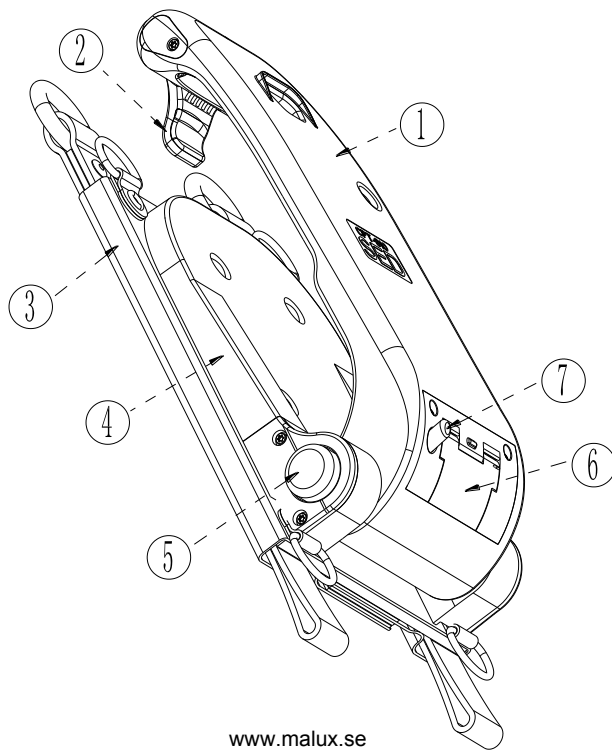

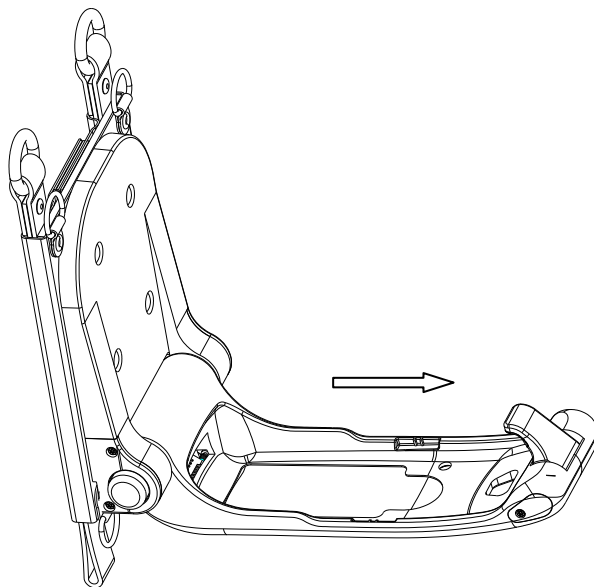

- ① Clamshell
- ② Phone fastening buckle
- ③ Leather case
- ④ Base
- ⑤ Spindle button
- ⑥ Tail plug buckle
- ⑦ Tail plug buckle button

To open the clamshell, press the button shown in ⑤; otherwise, the holder cannot be used again if the spring is broken.

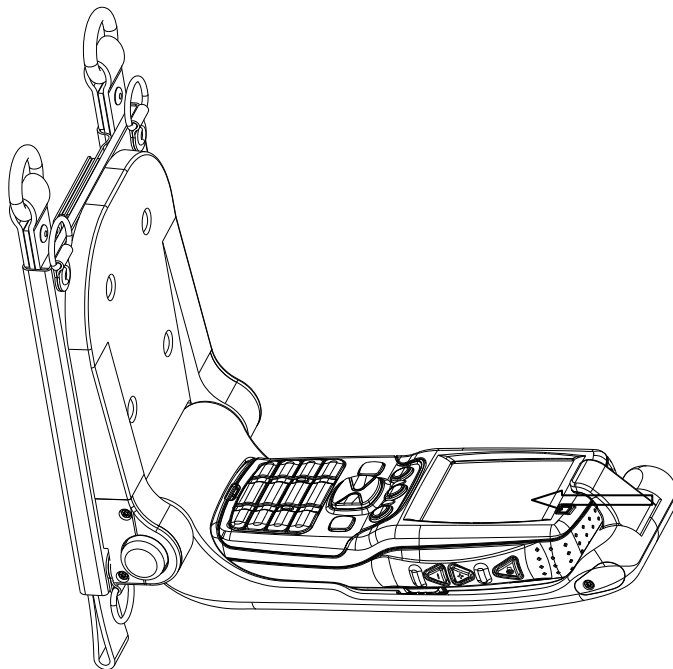



After the clamshell is open, insert the OPS from top to bottom into the holder. Press & hold the locking apparatus until the device is engaged in.

**Note:**

*If the holder is forced to be open with an angle of more than 90° in special scenario, the holder can be restored to the position with an angle of 90°. However, the internal component of the holder undergoes strong stress. Therefore, you are advised not to open the holder with an angle more than 90°.*

*When you press & hold the tail plug buckle button, the tail plug buckle is automatically opened. When a tail plug such as a data cable is inserted, ensure that the surface of the tail plug with the SED logo is consistent with the screen direction of the mobile phone.*

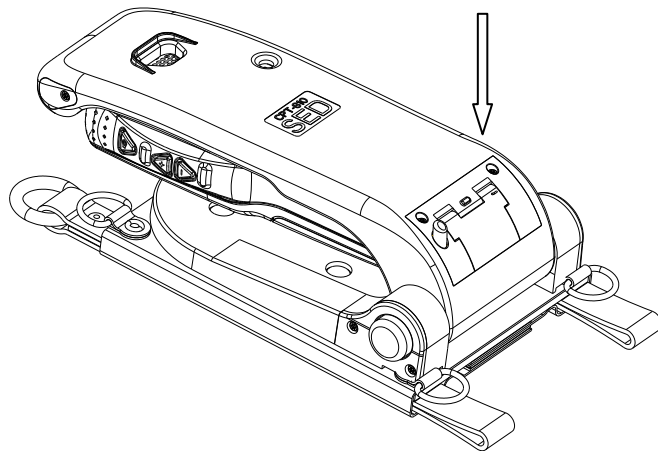

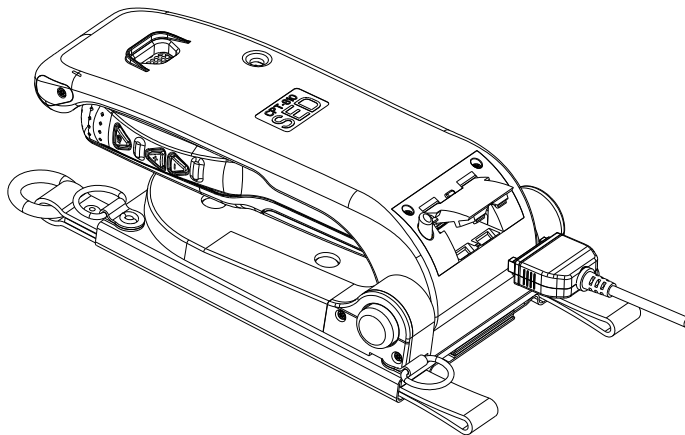

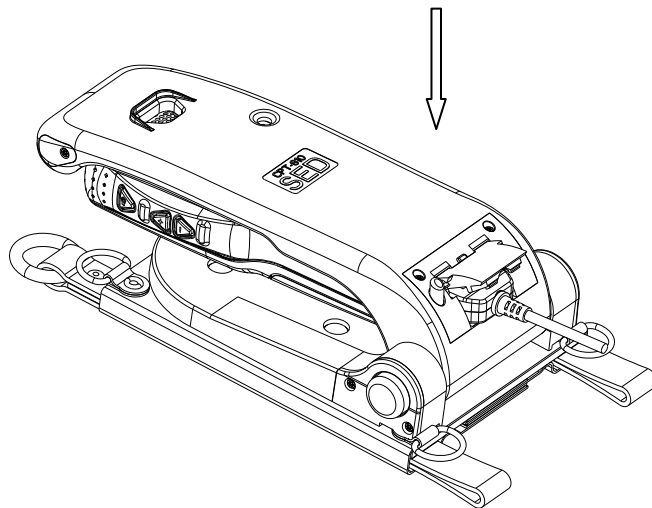

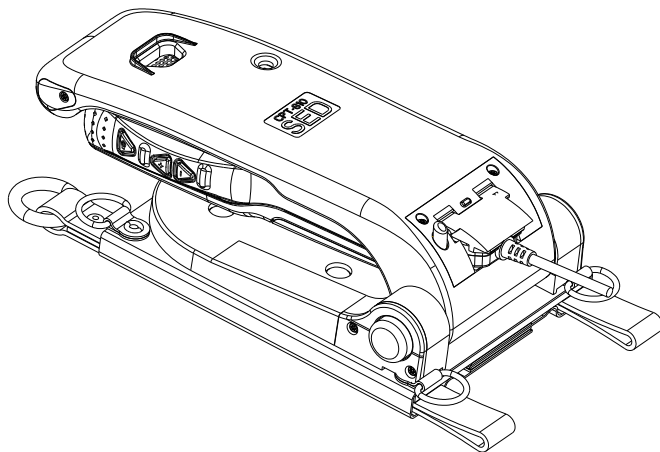

## 2.8 Clip Operations for OPS

As shown in the figure, aslant insert the mobile phone into the rear case, and then press the mobile phone into the rear case in the direction shown by the arrow to mount the mobile phone. When dispatching the mobile phone, pull the knob position ⑥ of the rear case in the direction shown by the arrow and rotate the mobile phone outward.

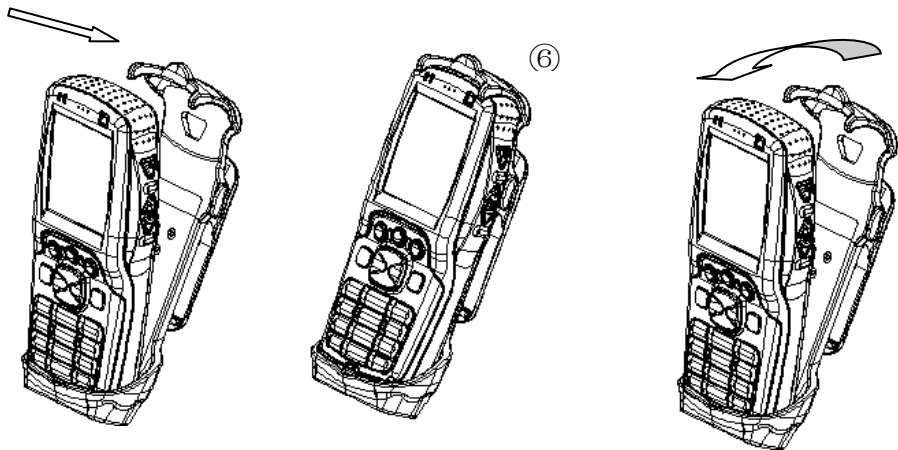

After the mobile phone is mounted, various mobile phone accessories such as data cables, external Bluetooth devices, and handheld microphones can be connected to the mobile phone. All external accessory connectors are shown in the following figure. Manually fasten two screws to the rear case.

**Note:** The surface of the connector with the SED label must be upward; otherwise, the screws cannot be locked.

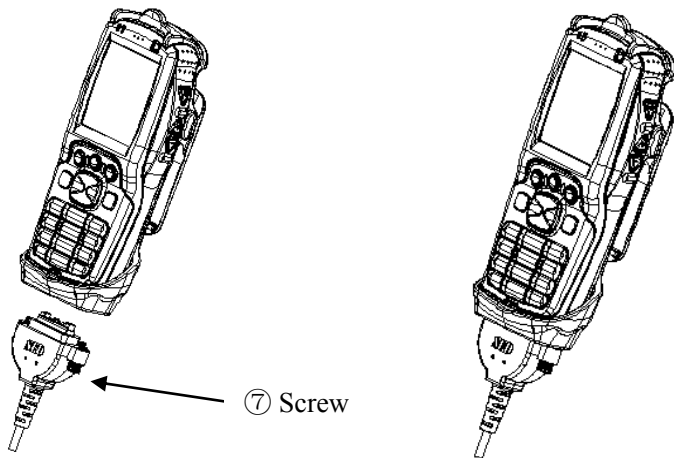

### **3 Conventional Call Service (ASD)**

#### **3.1 Railway Internal Fixed Telephone Network (Basa Network)**

To initiate a call, the device must be registered with a valid network. You can use the OPS in the railway internal fixed telephone network (Basa network) for a call. Therefore, you need to select **901** in advance, then select an area code in the Basa network, and enter a user number, for example, 901-959-12345.

#### **3.2 Call Initiation**

##### Select

To initiate a single call with another party, use the number keys to enter a phone number.



### Redial

After press the green call key, the latest 20 numbers you dialed can be displayed. You can use the up and down keys to select a number from the recent 20 numbers, and then press the green call key again to redial.

### Address book

In the address book, you can use the up and down keys to select a number as required, and then press the **OK** key for browsing.

## **3.3 Answering a Single Call**

If you have a single call, press the green call key to answer the call.

## **3.4 Terminating a Single Call**

Press the red hang-up key to terminate a call.

## **3.5 Storing a Phone Number**

You can use the address book menu to store a phone number.

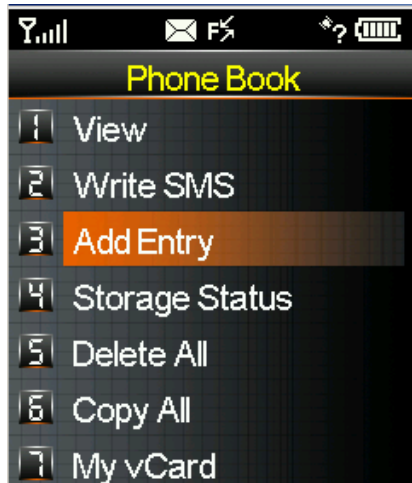

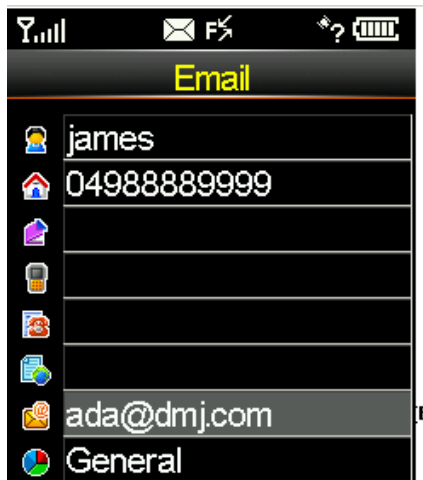

Select **Add Entry**, and then use number keys to enter a number.

### 3.6 Call Waiting, Call Holding, and Conference Call Initiation

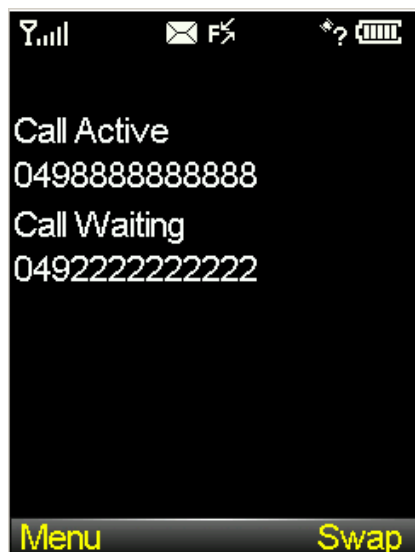
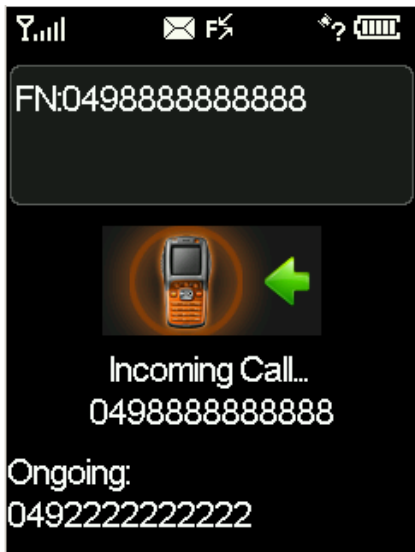

Call waiting means that there is a new call during the current connected call. You can know another call through the tone indication. The phone number as well as the name and function number is displayed on the screen.

You can use the red hang-up key to reject the incoming call, or use the green call key to answer the incoming call and the previous call becomes in the holding state.

If you determine to answer the incoming call, you can use **Swap** menu to switch between the two calls. The held call is in the holding state, and its information is automatically displayed on the screen.

The call holding function allows you to switch between two calls.



If you need to make a call with two parties, you can initiate a conference call instead of call holding. In this case, you can communicate with each party any time.

To initiate a conference call, use the **Build Multi-Call** in the menu.

A maximum of six parties are supported in a conference call.

## 4 Shunting without Use of Wireless Shunting Group

### 4.1 Using Train Number/Shunting Train Number for Registration

The mode of "shunting without a shunting group" is used in GSM-R training wireless networks. The single-call connection is used for a call in the shunting wireless network in a point-to-point manner.

Shunting participants and drivers perform function registration.

A shunting participant uses the following manners for login:

- In the case of the train shunting number, use the train number (five digits), function number 10, and shunting participant.
- In the case of the area shunting service, use the train shunting number (eight digits), function number 10, and shunting participant.

The following describes the procedure beginning with basic information.

Use  to display the shortcut menu, and choose **FN Register Guide**.

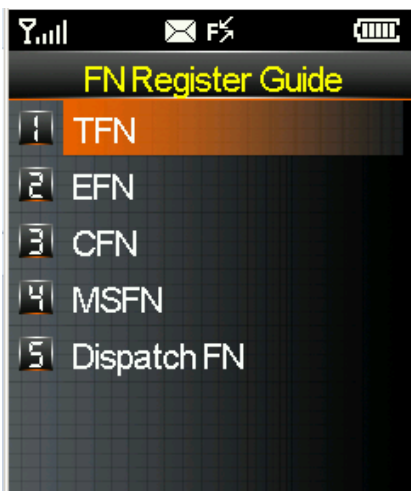

Choose **TFN** to display the function number registration page. After you enter relevant information, press the **OK** key. In the case of the train shunting mode, enter five-digit train number (pad zeros if the train number has less than five digits).

In the case of the area shunting service mode, enter the eight-digit shunting number. The shunting number always starts with 55, and is followed by an area number. The shunting number ends with the



five-digit shunting number.

**TR 66271 Chief Conduct.**

Finally, use the **OK** key to

confirm the registration. After the registration is successful,

**TR 66271 Chief Conduct.**

is displayed on the idle screen.

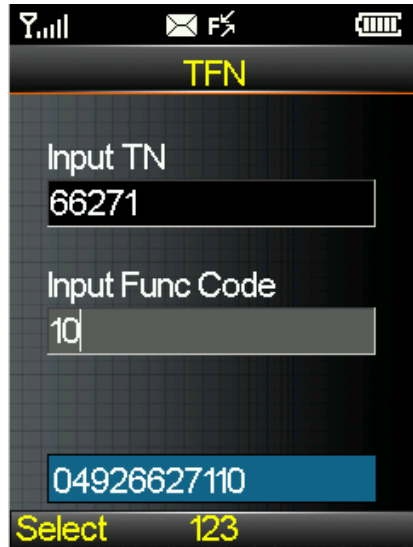
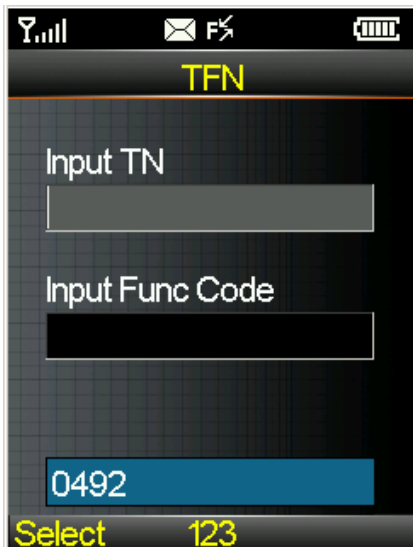



The way the train shunting conductor logs in to the OPS is the same as the way the shunting participant does. The only difference lies in the function identifier.

01	Leading Driver
02	Other Drivers #1
03	Other Drivers #2
04	Other Drivers #3
05	Other Drivers #4

As a driver, use the train number/shunting number and the vehicle location to log in.

## **4.2 Call Number When Train Number Is Used for Shunting**

When the train number is used for shunting, the call number consists of the following:

- Call type 2 (call type 2 is used for the train number mode)
- Five-digit train number (replace non-digit characters with zeros)
- Function identifier
  - 01 Main vehicle
  - 02 Second batch of trains
  - 03 Locomotive
  - 04 Vehicle entrance
  - 04 Vehicle exit

In the Shunting without Use of Wireless Shunting Group mode, when the train number is used for shunting, the call number is as follows:

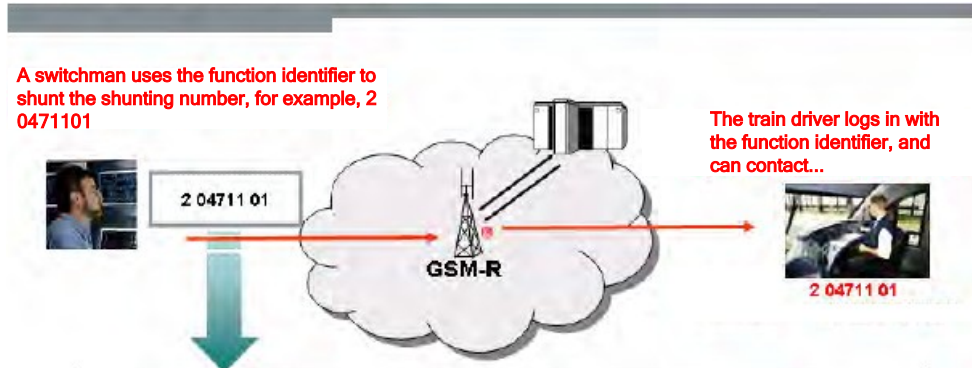

**Note:** The driver needs to use correct function identifier matching the shunting number to log in. Therefore, you can use Leading Driver function number to find the driver.

### 4.3 Call Number When Shunting Number Is Used for Shunting in Area Shunting Service

The entire shunting number consists of the following:

- Call mode 2 (train wireless network)
- Prefix 55 (used for the shunting number mode)
- An area number

1 = East

2 = North

3 = West

4 = Southeast

5 = Central

6 = Southwest

7 = South

- Five-digit shunting train number
- Function identifier

An example of the call number is as follows:

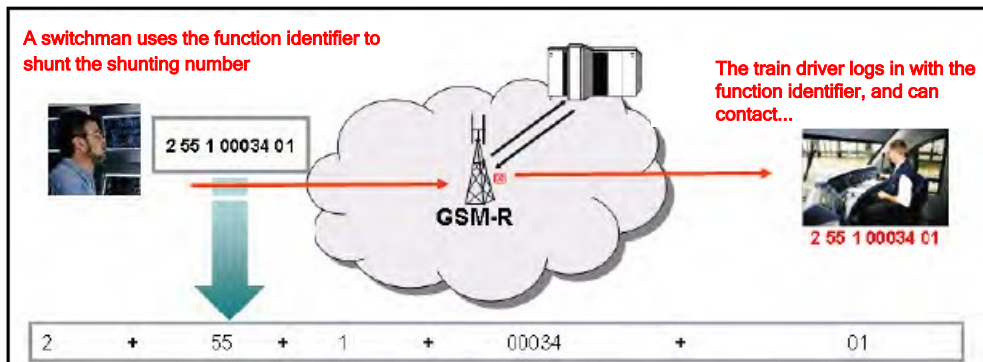

#### 4.4 Call Initiation

To establish a connection with the driver, use the number keys to enter a complete call number (shunting train number, or train number with a function identifier).

Alternatively, you can redial a call number or use the phone book. For details, see section 2.2.

To end the call, press the red hang-up key.

## **4.5 Calling a Fixed Number**

A quick dial number is associated with the wireless shunting user and the SIM card, for example, quick number 1350.

You can use the select keys to enter a number, and then use the green call key to confirm it. Alternatively, you can establish the connection (point-to-point connection) without using the call key.

In addition, you can use call mode 7 to obtain the eight-digit function call number of the fixed user, where the call number is provided in the SIM card (for example, 75030402). Likewise, the connection can be used in the group call PTT mode.

## **4.6 Conference Call**

you can initiate a conference call, as described in section 2.6. A maximum of six users can be connected to the conference call.

Tips:

Initiate a conference call only for important calls. This is because conference calls do not support call switch, the point-to-point mode is used instead, and a separate call channel needs to be established for each user, which limits other connections in the GSM-R wireless network.



## 4.7 Exiting Train Number/Shunting Train Number

After exit the shunting mode, the function ID needs to be Deregistered.

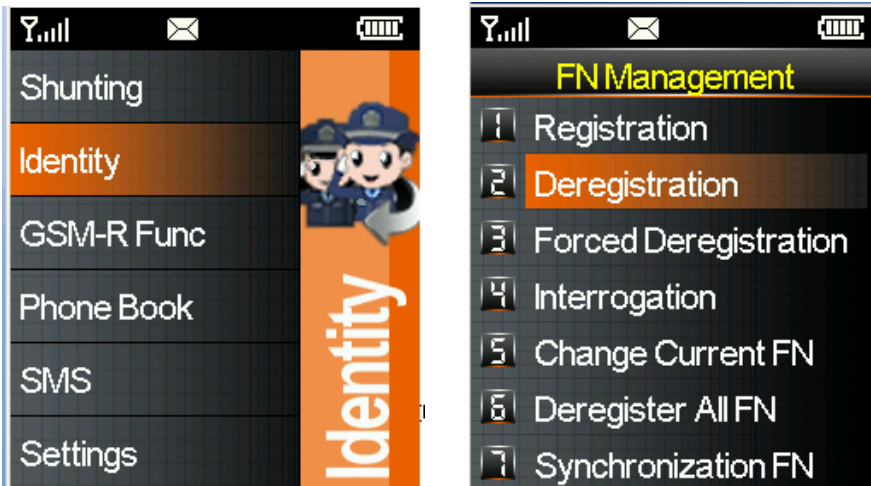

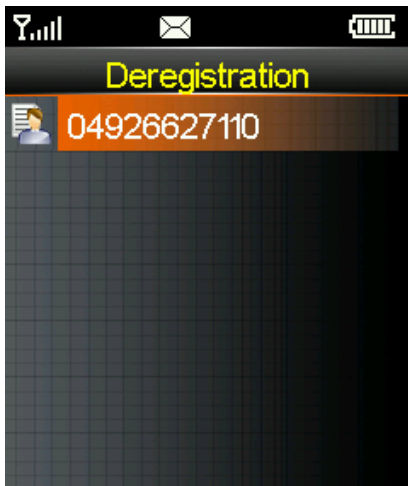

Press the **OK** key to display the main menu, choose **Identity>Deregistration** to display the deregister the function number UI, and press the **OK** key.

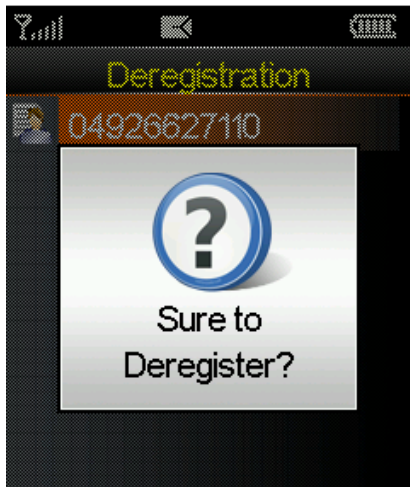

Then, you are not in the registered state.

#### 4.8 Public Group Call

You can initiate a public group call (GRP 250 – 259) to implement communication between a mobile user and a fixed user. To achieve this, the mobile user needs to log in to the railway wireless network.

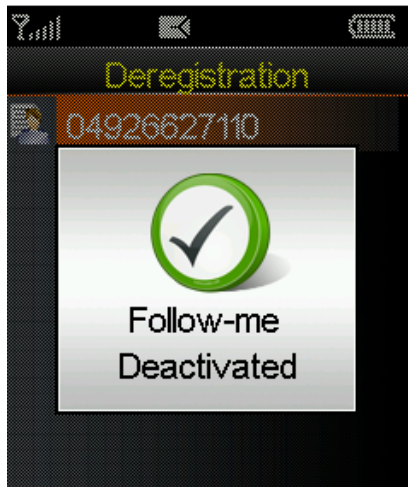

## 4.9 Emergency Call

The emergency call is a group connection with top priority.

You can terminate any existing single-call connection or group connection but cannot terminate an existing emergency call connection.

**Note:**

*When you do NOT use the wireless shunting group call for shunting (Shunting without Use of Wireless Shunting Group), the train emergency call function is used.*

Pay attention to the shape of the emergency call key. To avoid misoperations, after long-press the emergency call key, you need to use the PTT key to confirm the emergency call.

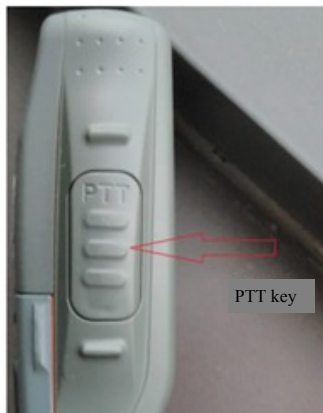

After an emergency call is connected (also applicable to misoperations), an emergency notice can be sent. The emergency notice may include the following content:

- Operation danger information
- Emergent stop command
- Emergency information
- Help
- The emergent stop command is sent only in dangerous cases. When the command is sent, all drivers in the shunting area must stop immediately.
- **Note:**
- *Because the group call exists during the emergency notice, you must press the PTT key (switch the call mode) for conversation.*

**Note:**

*If an emergency call is initiated incorrectly, the connection is NOT allowed to be terminated. Corresponding notice information needs to be sent.*

In the case of an emergency call, the OPS is operation-free, that is, the call is automatically answered and switched to the handfree mode.

Pay attention to the notice information on the receiving position of the emergency call, and perform corresponding operations.

To end the call, press the red hang-up key.



## 5 Shunting Group Shunting of OPS

### 5.1 Enabling GSM-R Wireless Shunting Function on the OPS

The wireless shunting group consists of mobile and fixed users. They can perform normal wireless communication using the group connection.

The wireless shunting area is an area with a defined function and limited location, and is used for shunting. The area uses five-digit shunting area code for identification.

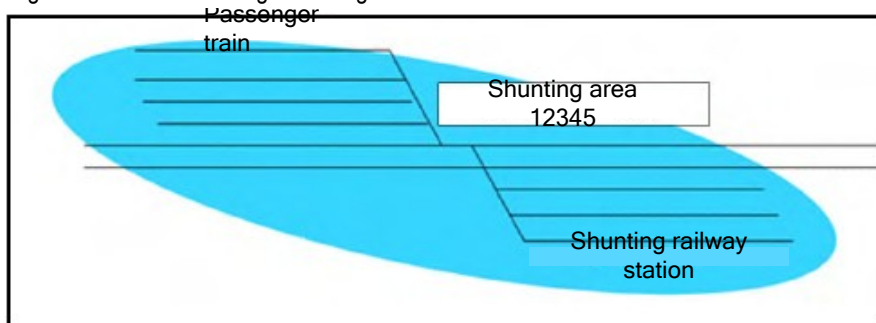

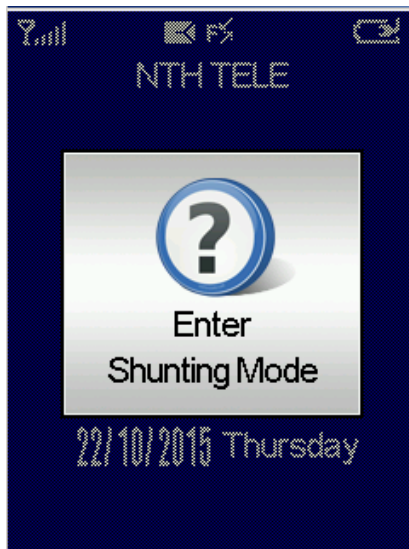

In the standby state, press . The UI asking whether to enter the shunting mode is displayed.

Press the **OK** key to display the shunting area interface.

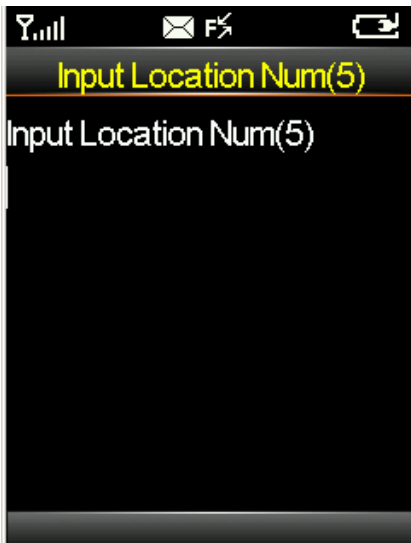

For first use, you are required to enter the number. From then on, this number will be remembered.

Enter an area, for example, 60522. The shunting mode of the area is displayed.



Now you can perform shunting in the area 60522.

## 5.2 Initiating Group Call in GSM-R System

The group call supports the call switch mode, that is, you can not only hear the sound but also make a talk. To initiate a group call, press the PTT key on the left on the device. After the call is established, the speaker is automatically enabled.



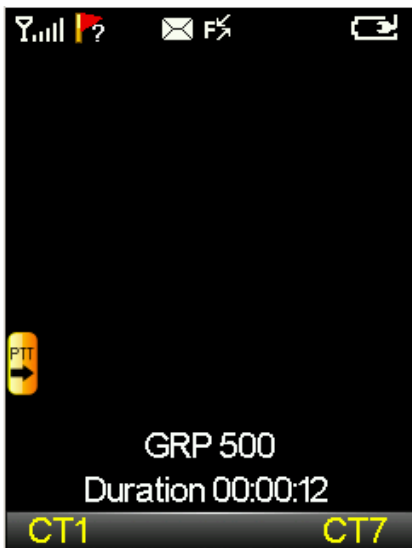

In such a manner, you can find an existing group call.

To speak, you need to press & hold the PTT key. Before you speak, wait for the tone indicating your turn for speaking.



### 5.3 Call in Particular Wireless Shunting Group

If a mobile GSM-R user switches to the shunting operation mode, the user first enters the general shunting group **00**. This group can be used by all shunting users who have not entered a dedicated shunting group. In the general shunting group, the mobile user cannot register or use a related function number.

Registration can be performed only in a dedicated wireless shunting group.

#### Example:

For a train that needs to be shunted for moving after driving, if a shunting area is specified for the train, the device needs to be switched to the GRP 500 general shunting group. For example, a user of the general shunting group 00 can contact another user in the shunting team 00 to determine together whether to switch to a dedicated shunting team.

After enter shunting mode, the background of the standby interface is in orange. The icon  indicates that the user is in the general shunting mode and the shunting function number is not registered yet. The icon  indicates that the user is in a dedicated shunting mode and a corresponding function number is registered.



In the general shunting group, if there's no one talking for over 30 seconds , the group call is automatically terminated. To initial a group call again, press the PTT key.

## 5.4 Switching Shunting Area



After the shunting mode is entered, press  on the standby interface, after input a new shunting area, press the key OK .



**Note:** *the shunting area number entered by misoperations cannot be recognized as an error. Therefore, ensure that the shunting area number input is correct.*

## 5.5 Dedicated Shunting Group

### 5.5.1 Registration in Dedicated Shunting Group

The maximum number of persons allowed in each shunting team is as follows:

- 3 drivers, - Leading Driver, Other Drivers #1, and Other Drivers #2
- 3 shunting participants - Leader, Leader 2, and Leader 3
- shunting staff , - Member 1, Member 2, Member 3, and Member 4
- For GSM-R wireless shunting, you can set **501 – 529 shunting teams**. These teams can be set in your shunting area.

- Before registration in the dedicated shunting team, press the up  or down  key on the front side of the OPS until you select the correct group, and press the OK key.

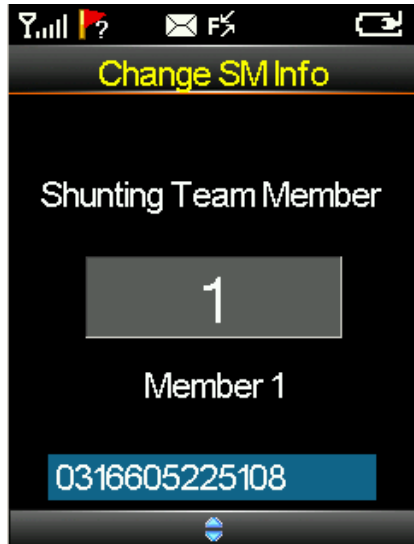



After the dedicated shunting UI is displayed, the team number is 08, the member is 1, and the flag is green.

### **5.5.2 Initiating/Terminating a Call in Dedicated Wireless Shunting Group**

The way you enter a call is basically the same as the way you enter the general shunting team 00.

### **5.5.3 Exiting Shunting Group**

Press the red hang-up key and operate as prompted on the screen to exit the group call.

### **5.5.4 Ending Shunting Group**

If a user ends the group call, the call of all group users will be ended.

### **5.5.5 Fixed User Voice Call**

When the group call is enabled, you can use OPS to initiate voice call to a fixed user, so as to inform the user to join the group call.

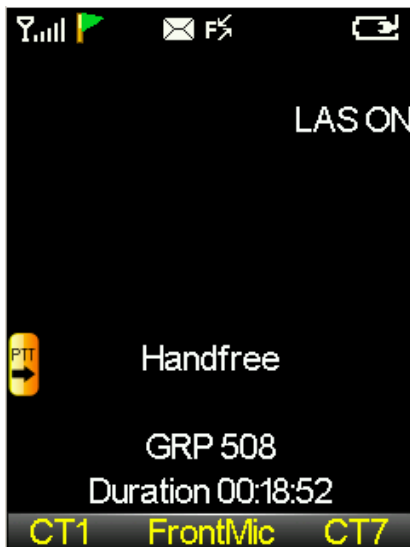

You can use keys CT1 and CT7 to initiate the voice call. Use a quick dial and use a dialing number.

## 5.6 Switching Wireless Shunting Group

To switch a shunting team, you can press key **UP** and **DOWN** on the OPS until you find the required team.

Use the **OK** key to confirm your selection.

Next, you can use the select keys to select your function (similar to previous operation).

Use the **OK** key to confirm the operation, and then you can switch to the dedicated shunting group.

## 5.7 Emergency Call When Shunting Is Performed in Dedicated Shunting Group

The emergency call is a group call with top priority.

You can terminate any existing point-to-point call connection or group call connection but cannot terminate an existing emergency call connection.

### 5.7.1 Initiating Wireless Shunting Emergency Call

**Note:**

*When shunting (Dedicated Shunting Group) is performed in a shunting group, a shunting emergency group call will be received.*

After an emergency call is connected (also applicable to misoperations), an emergency notice can be sent. The emergency notice may include the following content:

- Operation danger information
- Emergent stop command
- Emergency information
- Help

In an existing connection, only the staff responsible for shunting and wireless shunting staff can query a user who sends an emergency notice.

**The emergent stop command can be sent only in dangerous cases.** When the command is sent, drivers in all shunting areas or some shunting areas must stop immediately.

**Note:**

*Because the group call exists during the emergency notice, you must press the PTT key for speaking.*

**Note:**

*If an emergency call is initiated incorrectly, the connection is NOT allowed to be terminated. Corresponding notice information needs to be sent.*

## 5.7.2 Answering and Terminating Shunting Emergency Call

In the case of an emergency call, you do not need to answer the call, that is, the call is automatically answered and switched to the handfree mode.

To terminate the call, press the red hang-up key. Note that only the initiator can terminate the call.

## 5.8 Ending Shunting

This option is available regardless of whether the user is registered (that is, whether registered with a function number).

If the user wants to end shunting, the device releases all enabled connections.

To end shunting, do as follows:



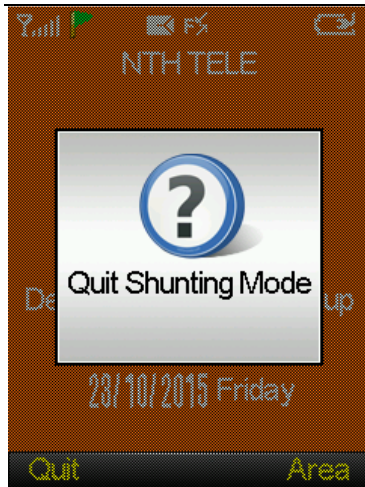

In the shunting mode, press  on the standby UI.

When a dialog box is prompted, press the **OK** key to exit the shunting mode.

## **6 OPS in Nationwide Roaming**

### **6.1 Features in Roaming Networks**

In a few cases, the public GSM network may be used in a small shunting area. If expanding the GSM-R network is costly, the GSM-R infrastructure may not be constructed.

Roaming mode: If the self-run GSM network cannot be used currently, the device can be handed over to the external GSM network. It is similar to using mobile phone abroad.

Nationwide roaming can be understood as using public GSM network (such as T-Mobile D1) instead of the GSM-R network to perform shunting. In this case, the SIM card of the GSM-R terminal device must have relevant permissions.

No matter whether the GSM-R user is in other networks, the user can be contacted by using its GSM-R call number.

In this case, the group call is no longer used. Instead, only the call connection in the point-to-point conversation mode is used.

In addition, the conference call can be initiated as required.

**Disadvantages:**

- Only single-call can be used.
- Railway emergency call cannot be used.

If shunting communication is required in Nationwide Roaming, the Nationwide Roaming user needs to register with the roaming network. The Shunting without Use of Wireless Shunting Group mode is adopted for shunting, and the shunting number (8 digits) or train number (5 digits) is used.

**Note:**

***In this case, neither wireless shunting emergency call nor wireless train emergency call can be initiated. The quick number 1350 does not work in Nationwide Roaming.***

## 6.2 Switching OPS to T-Mobile D Roaming Network

On the standby UI, press the **OK** key to display the main menu, and choose **Settings**.



Then, choose **Call Setup**.

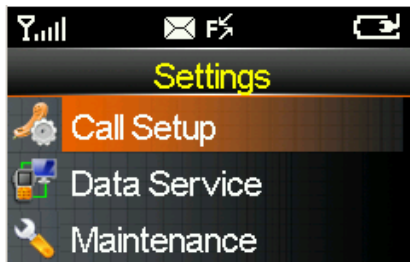

Enter the **Network Selection** option.

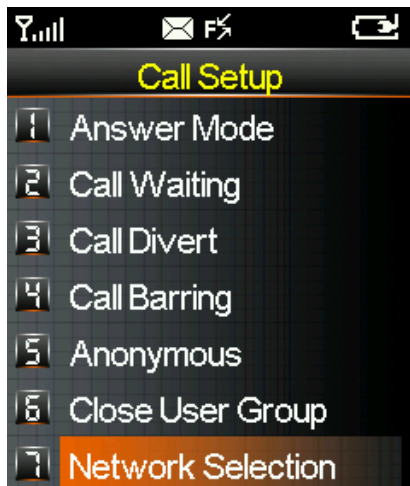

Choose **Manual**. Wait when the system is searching the network list. Then, select a network for registration, and press **OK**.

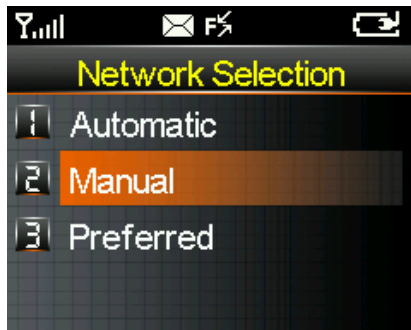

After the network is selected, the letter m is displayed in the antenna icon, indicating that the system is in the manual network selection mode.





## **6.3 Returning to GSM-R Network**

Before returning to the GSM-R network, perform the operations described in section 5.2. Select GSM-R D instead when performing the operations.

## 7 Independent Individual Operation Emergency Alarm

### 7.1 Working Alone Call Mode

The model of the brand new portable digital wireless shunting terminal is OPS. The device provides the independent individual operation emergency alarm function, which can set based on personal requirements. The function provides protection for all staff.

Currently, the standards comply with VA1-32 (working safety and health protection organization and safety regulations). A manner in which all staff must use a call number to report at an interval of 60 minutes is replaced because the Working Alone (static alarm mode or tilt alarm mode) technical solution of the OPS is introduced.

The OPS terminal device has a motion sensor, tilt sensor, and GPS receiver, with which the terminal device can initiate individual emergency calls in a defined time period when the device is still or inclined for a specified time.

### 7.2 Emergency Reporting Configured based on Personal Requirements

When the OPS becomes faulty, pre-alarm (warning level T0 = 90 seconds) can be started on the terminal device. The pre-alarm has no visible prompt when started. If the fault of the terminal device persists, the OPS starts to vibrate (pre-alarm T1 = 20 seconds). If the fault persists after the pre-alarm ends, the terminal device buzzes, indicating the fault status (local alarm T2 = 30 seconds).

If the fault persists after the local alarm ends, the device initiates individual alarm call to the receiving center. In this case, the terminal device of the staff automatically initiates a call to the terminal receiving station. In addition, an SMS message including the OPS GPS location data is also sent to the receiving station. In this way, the staff of the receiving station can know the current location of the terminal device from the screen, and take corresponding measures.

After a fault is corrected, if a fault occurs again before sending a report, the terminal device sends a pre-alarm according to the previous step.

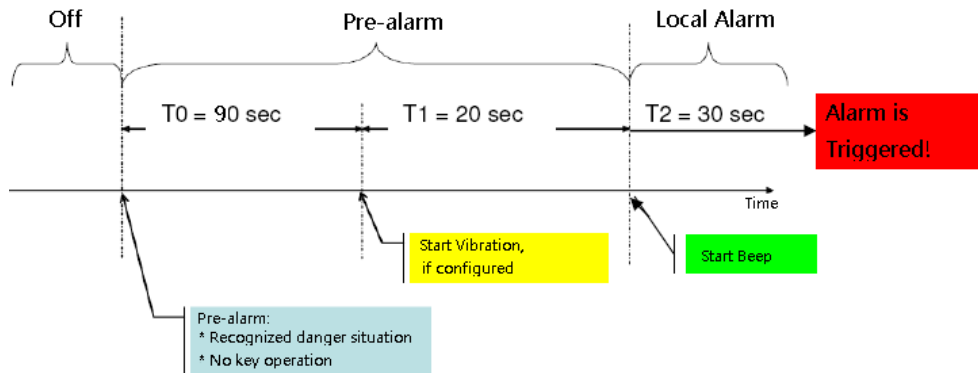

## 7.3 Enabling Working Alone Function of the OPS

On the main menu, choose **Settings>Tools**.



Choose **Working Alone** from **Tools**, and then choose **On** to activate the function.



**"No Motion Alarm"** mode : The handset remains stationary without any operation on it in a preset time;

**"Tilt Alarm"** mode : The handheld tilts over the set angle threshold without any operation on it in a preset time;

**Note:** default set is "No Motion Alarm" mode.

## 7.4 Disabling Working Alone Function of the OPS

For details, see section 6.3. However, choose **Off** instead from **Working Alone**.

## 7.5 Enabling Independent Individual Operation Emergency Alarm

Working Alone emergency reporting can be manually initiated based on individual requirements.



Long-press . Then, a dialog box is displayed, prompting you whether to initiate the alarm. At this dialog box, press the PTT key to initiate Working Alone emergency alarm.

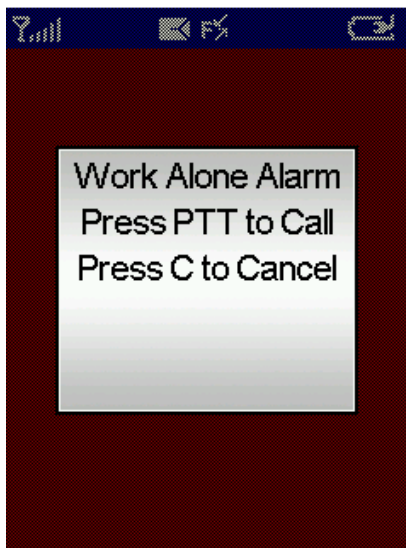

Similar to manually initiating Working Alone emergency alarm, the OPS can automatically initiate a alarm call from the terminal device to the receiving station. In addition, an SMS message including the OPS location data is also sent to the receiving station. The staff of the receiving station can know the current location of the terminal device from the screen, and take corresponding measures.

## 8 COUNT DOWN Function Introduction

After the OPS is disconnected from the network, the OPS enters into the 50-minute countdown state, and the blinking words prompt the user to go to a reachable location. Otherwise, when personal safety risks are posed, the Working Alone function is unavailable due to unreachable networks. As a result, the contact with the control console cannot be maintained, and timely handling cannot be ensured if personal safety risks are posed.

## 9 Tools

### 9.1 RF Monitoring

After entering the menu Tools->RF monitoring, you can look up network information on your handheld. Generally, the first page on your handheld displays the information of serving cell, and page 2 to page 7 display the information of its six strongest neighbor cells.

Support serving cell Serving Cell: BCCH, RX, C1, C2, CI, LAI, RQ, BSIC, RM, TX, TS, Neighbour Cells : BCCH(the Channel), RX, C1, C2, FNO, QBO, BSIC, RM, TX.

### 9.2 Bluetooth

You can make a voice call via Bluetooth device. However, you have to connect your handheld with the Bluetooth device at first.

This menu has 5 submenus: ON/OFF, Name, Set Pair PIN code, Bluetooth Scan, Bluetooth List.



### 9.3 Cell forcing

You can force the mobile to camp on a target cell in idle or dedicated mode, it will force handover in dedicate mode. An icon will be prompted in status bar. Select Cell Forcing and press OK to enter the setting screen. You can enter ARFCN of target cell in this menu. Press OK to enable the forcing mode.

**Note:** *If the forcing ARFCN is not a BCCH ARFCN, your handset will lose service. In Dedicate mode, the forcing ARFCN shall be one of the six strongest neighbor cells that BSICs have been decoded.*

*The success of handover finally depends on the network*

### 9.4 Cell lock

You can use this function to lock the current serving cell, it will deactivate cell reselection and handover. An icon will be prompted in status bar. You can also select Cell Lock and press OK key to switch between forcing mode and non-forcing mode.

**Note:** *The priority of **Cell forcing** is higher than **Cell lock**. **Cell lock** and **Cell forcing** cannot be used simultaneously*

## 10 Reference Information

### 10.1 Access Password

The handset and its SIM card support many passwords, which can protect both against unauthorized access.

#### **PIN**

Personal Identification Number (PIN) protects the SIM card against unauthorized access. Usually the PIN is provided with the SIM card. When the power-on PIN is enabled, you need to enter this password every time you switch on the handset.

**Note:** *If you enter the incorrect PIN three consecutive times, the SIM card locks. Then, you need to enter the PUK to unlock the SIM card. Certain operators do not provide the PUK code. Therefore, if you are asked to enter the PUK, contact your operator immediately. Do not enter any characters on your own.*

#### **PIN2**

Usually PIN2 is provided with the SIM card. PIN2 implements certain functions, such as charge rate. These functions are implemented only when your SIM card supports these functions.

If you enter the incorrect PIN2 three consecutive times, PIN2 locks, and you need to input PUK2 to unlock PIN2.

#### **PUK**

PUK is used for changing a locked PIN. The PUK is provided with the SIM card. If it is not, contact your local service provider. If you enter the incorrect PUK ten consecutive times, the SIM card cannot be used anymore. Apply to your local service provider for a new SIM card. The PUK cannot be

changed. If the PUK is lost, contact your service provider.

## **PUK2**

PUK2 is usually provided with certain SIM cards. The PUK2 is used to change a locked PIN2. If you enter the incorrect PUK2 ten consecutive times, you cannot use certain functions any more. Apply to your local service provider for a new SIM card. The PUK2 cannot be changed. If the PUK2 is lost, contact your service provider.

## **10.2 Battery use**

The handset uses special lithium rechargeable batteries.

Charge and discharge:

The new battery reaches optimum performance after two or three complete charge and recharge cycles. Therefore, during the first charge cycles, charge the battery for more than five hours. In this case, you can ignore the full battery message. Deplete the battery until the handset powers off automatically, and then completely recharge the battery. A charged battery will discharge over a certain period if it is not used.

## **10.3 Precautions for battery use**

- For safety reasons, do not use any damaged rechargeable batteries.
- When you use the handset near a network base station, battery consumption is low. Therefore, the call and standby duration is largely affected by the signal strength of the cellular network and parameters set by the network operator.
- The battery charge time depends on the remaining battery capacity and the type of battery and charger. Rechargeable batteries can be used repeatedly, but will ultimately fail. When the usage time of a battery (call time and standby time) declines significantly, consider buying a new

battery.

- A fully charged battery will discharge if it is not used.
- Use the designated battery and charger. Cut off the power when the charger is not in use. Do not connect the battery to the charger for over a week. Overcharging will shorten the life of the battery.
- Do not store the battery in places of extreme temperature; for example, in a car in the summer or winter, or the capacity and lifecycle of the battery will degrade. Try to maintain a constant indoor temperature for the battery. The handset may fail to work temporarily in an environment that is either too hot or too cold, even if the battery is fully charged. Usually the discharge characteristics of lithium-ion batteries deteriorate in an environment below zero degrees Celsius.
- Do not short circuit the battery contacts. For example: If put an idle battery in your pocket or bag with metal objects (coins, pins or pens), and the objects directly contact the positive and negative poles of the battery (the metal bars at the back of the battery), the battery will short circuit. This damages the core or protection circuits inside the battery.
- Dispose of (usually recycle) waste batteries according to local regulations.
- Do not expose batteries to fire.

#### **10.4 CAUTION**

**RISK OF EXPLOSION IF BATTERY IS REPLACED BY AN INCORRECT TYPE. DISPOSE OF USED BATTERIES ACCORDING TO THE INSTRUCTIONS**

#### **10.5 Careful Maintenance**

The following suggestions help you comply with the warranty clauses and prolong the lifecycle of your handset. When you use the handset, battery, charger or other accessories:

- Place the handset and all the accessories beyond the reach of children.
- Do not put the handset in a dusty place; otherwise, its movable parts will be damaged.
- The LCD is a vulnerable part of the handset. Avoid dropping the handset on the ground and collisions with other objects. Prevent sharp objects from scratching the LCD.
- Do not put the handset in hot places. High temperatures shorten the lifecycle of electronic devices, damage the battery, lift the edge of the device, and melt plastic parts.
- Do not put the handset in cold places. When the handset is moved from a low-temperature environment to a normal or high-temperature environment, vapor is generated inside the handset as the temperature rises, thus damaging the electronic circuit boards.
- Do not throw, knock or shake the handset. Rough treatment could damage the internal circuitry.
- Do not use coarse chemical agents, cleaning solvents or strong pharmaceutical cleaning agents to clean the handset.
- Do not paint the handset. Paint may stick to the movable parts of the device and affect normal operations.
- Use only equipped or designated antennas. Unauthorized antenna, accessories or modifications can damage the handset, and could violate the rules governing radio devices.
- If the handset, battery, charger or any accessory do not work, take the faulty part to the nearest qualified maintenance company.

## 10.6 Glossary

### Antenna

It is the device for transmitting and receiving signals. The size and shape of antennas depend largely on the frequency of the signals they receive. Handsets and base stations must be equipped with antennas.

**Call Barring**

It is the restrictions on making outbound calls and answering incoming calls.

**Call Divert**

It is the ability to divert voice calls or data calls to other handsets or fixed phones.

**Call hold**

Call hold allows you to switch between the two calls if an incoming call is received during another call.

**Call wait**

You are notified if an incoming call is received during another call.

**Conference call**

A multi-party call can have a maximum of six parties. This function requires network support.

**Hands-free**

With this function, you do not need to pick up or hold a handset.

**LCD**

Usually refers to the screen display of a handset.

**Line recognition service**

This service allows you to display or hide your own number when making a call.

**PIN**

It is a security code that protects the handset against unauthorized access. The PIN is provided with the SIM card by the service provider. The PIN can comprise 4 to 8 digits, and can be changed as needed.

**PUK**

It is the password for unlocking the SIM card when you enter the incorrect PIN three consecutive times. The PUK consists of 8 digits, and is provided with the SIM card by the service provider.

**Roaming**

It is the service that allows you to use the handset in other networks except your home network; for example when you are traveling.

**SIM card**

This identification card with a crystal chip contains all the information (including network, memory, and subscriber personal data) required to operate a handset.

**Common SMS**

It is a network service that involves sending and receiving information to and from other users. A written or received message (with fewer than 160 characters) can be displayed, received, edited or sent.

**Cell Broadcast**

The network service provider sends broadcast information, such as traffic information and weather forecasts, to the handsets in the network coverage area. The information is sent to your handset in the form of text messages.

**Voicemail**

If your subscription includes voicemail, callers may leave a message when you cannot answer a call. To call your voicemail number, you can press and hold Key 1 in standby interface..

*Contact your network operator for more information.*

**PB**

Phone Book

**SMS**

Short Message Service

**vCard**

The Electronic Business Card

**IC**

International Code

**ISDN**

Integrated Services Digital Network

**MSISDN**

Mobile Station International ISDN Number

**CN**

Coach Number

**CUG**

Closed User Group

**EN**

Engine Number

**FC**

Function Code

**FN**

Functional Number

**LN**

Location Number

**MO**

Mobile Originated

**MT**

Mobile Termination

**PTT**

Push-To-Talk



**PLMN**

Public Land Mobile Network

**ASCI**

Advanced Speech Call Item

**STK**

SIM Tool Kit

## 10.7 Troubleshooting

If you feel that your handset has a problem, refer to the following problems and solutions. If the problem persists, contact the seller or service provider.

Problem	Solution
I cannot answer or make a call.	<ul style="list-style-type: none"><li>• Make sure that the handset is switched on.</li><li>• Make sure that a valid SIM card is correctly inserted.</li><li>• Make sure that the signal strength is sufficient.</li><li>• Make sure that call barring or fixed number dialing is not enabled.</li><li>• Make sure that call divert is disabled.</li><li>• Make sure that the correct network is selected.</li></ul>
Call volume is low	<ul style="list-style-type: none"><li>• Make sure that the call volume is set properly.</li></ul>
The handset does	<ul style="list-style-type: none"><li>• Make sure that the vibration mode or silent mode is not selected for</li></ul>

not ring.	<p>incoming calls.</p> <ul style="list-style-type: none"><li>• Make sure that the ringing volume is set properly.</li><li>• Make sure that call divert is disabled.</li><li>• Check if the surrounding environment is noisy.</li></ul>
The other party cannot hear me	<ul style="list-style-type: none"><li>• Make sure that mute is off.</li><li>• Make sure that the handset's microphone is near your mouth.</li></ul>
The PIN is locked.	<ul style="list-style-type: none"><li>• Contact your service provider to obtain the PUK for unlocking.</li></ul>
The battery cannot be charged.	<ul style="list-style-type: none"><li>• Make sure that the charger is properly connected.</li><li>• Check that the battery or charger is not damaged.</li></ul>
No network is available.	<ul style="list-style-type: none"><li>• Make sure that the SIM card is inserted.</li><li>• Check that your current position is covered by the service network.</li><li>• Try to move the location to change the reception status.</li></ul>
I cannot switch on the handset.	<ul style="list-style-type: none"><li>• Make sure that the battery is installed.</li><li>• Make sure that the battery is supplying power.</li><li>• Press and hold the power key.</li></ul>
The standby time has shortened.	<ul style="list-style-type: none"><li>• Make sure that the battery is fully charged.</li><li>• Check whether the signal strength in your current location is weak.</li><li>• Lower the LCD backlight.</li></ul>

I hear an echo or noise.	<ul style="list-style-type: none"><li>• Move to a place with a stronger signal.</li></ul>
--------------------------	---

