

Robust, weather-resistant telephone

ResistTel MB



Operating instructions



Our weatherproof phone offers precision, comfort, extended service life and reliability. It is programmable and it can withstand harsh environmental conditions. The phone can be used under severe conditions including seawater, high humidity, dust and it withstands strong mechanical shock. It is fitted with an indestructible keypad made of V4A steel and an extremely robust body made of shock and impact-resistant compression moulded plastic. All components used for making this phone are resistant against lye and lubricants. The 21-part keypad optimised for "use with gloves" and made of V4A steel is easy to operate and thus meets all requirements for a modern and reliable communications device. The ResistTel MB phone offers a reliable communication channel when connected to the public network or to PBX systems.

Table of contents

General operating conditions	4
Overview	5
Keypad	8
Package contents	9
Assembly and installation	9
Wiring diagram.....	11
Support hook	11
Hole pattern	12
Putting into service	12
Maintenance	12
Handset operation	13
Open listening	13
Hands-free operation	13
Using the headset	14
Operation	15
Receiving calls.....	15
Making a call.....	15
Redialling	15
Making a second call.....	15
Changing the phone settings	16
Signal tones	16
Configuration	17
Setting the ringer volume	17
Selecting a ringtone	17
Setting the speaker volume.....	17
Setting the speaker volume for open listening	17
Setting the speaker volume for hands-free operation	17
Setting the headset volume	17
Setting or deleting phone numbers for speed dialling	18
Setting the call procedure	18
Storing or deleting a trunk access code	18
Setting the waiting time after dialling a trunk access code	18
Setting the duration of a loop current interruption (flash time)	19
Activating/deactivating the change lock.....	19
Setting the PIN number	19
Activating/deactivating the external speaker.....	20
Restoring factory settings.....	20
Factory settings	21
Technical data	22
Legal requirements.....	25
Service	26
Care and maintenance	26
Disposal	26
Warnings and safety instructions.....	26
CE marking	27

General operating conditions

1. The ResistTel MB weatherproof phone can be connected to the telephone lines of analogue exchanges.
2. The handset is fitted with a stray field coil for connecting hearing aid devices. Persons wearing a hearing aid device with an inductive receiver can directly receive the signal of the earphone.
3. The optional external speaker can be used in ringer, open listening and hands-free modes. The volume of the internal speaker is reduced when the external speaker is turned on.
4. The phone has a receiver mount with a reed contact hook switch. The handset must be placed back on the mount to end the call. A conversation is ended and a new call is started by pressing the disconnect button on the keypad (see page 8).
5. If the you do not make a selection within 2 minutes, the exchange can cut off the power supply. Then you will stop hearing the dial tone. In this case, please place back the handset, wait for 2 seconds and lift the handset again.
6. An acknowledgement tone confirms that the settings have been stored.
7. When you receive a call, the ResistTel MB phone rings with the selected volume.
8. Changing the settings can be prevented by setting a PIN number. Forgetting the PIN number is similar to losing a key. If you forgot the PIN number, please contact our technical support service.
9. There is a warranty period of 36 months from the date of purchase. In case of any problems please contact our technical support service in Germany, Mülheim an der Ruhr

Phone: 0208 82 68 0 · Fax: 0208 82 68 286 · E-mail: info@fhf.de

Please use the country code if calling from outside Germany:

Phone: +49 208 82 68 0 · Fax: +49 208 82 68 286

In case of issues which cannot be solved by phone, please send the complete device with a copy of the sales receipt to the following address:

FHF
Support ResistTel MB
Gewerbeallee 15-19
D-45478 Mülheim an der Ruhr

If no errors are found during the inspection, we shall issue an invoice for the processing fee.

Overview of the device

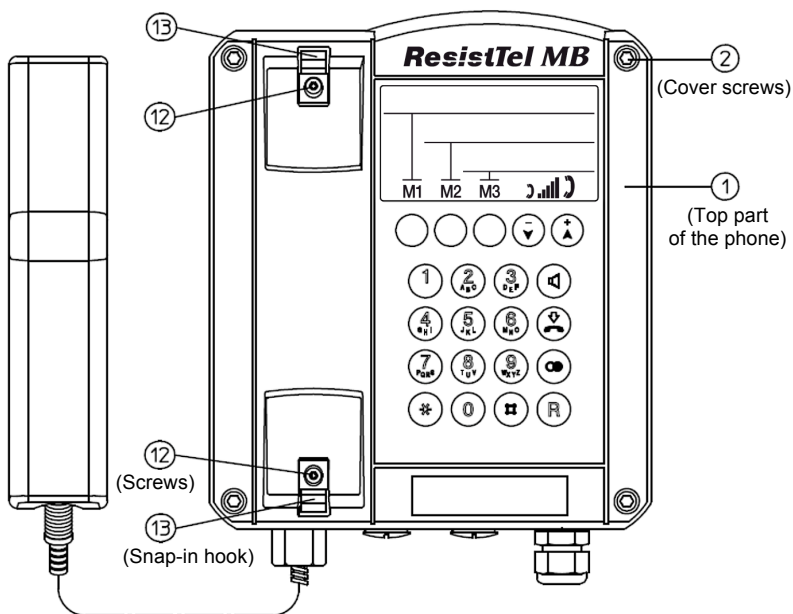

Exterior view of the lower part of the phone

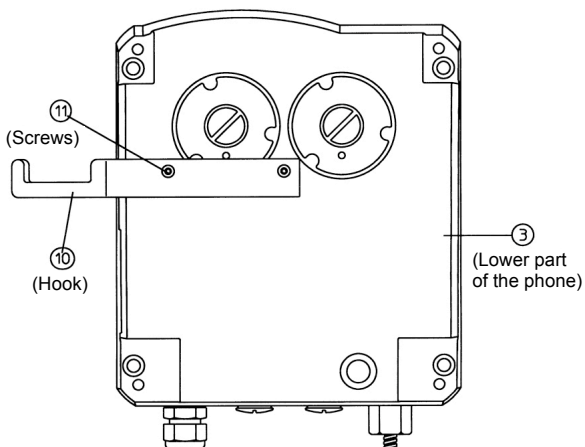

Interior view of the upper part of the phone

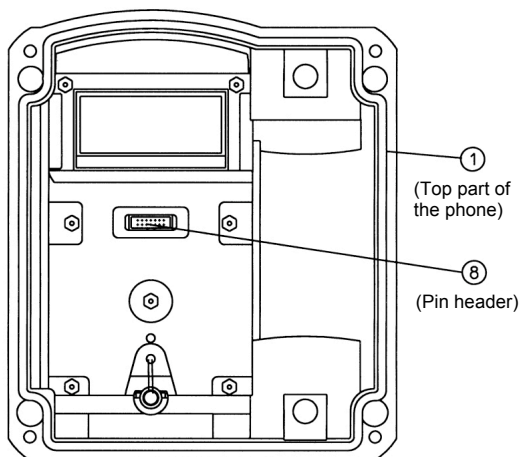

Interior view of the lower part of the phone

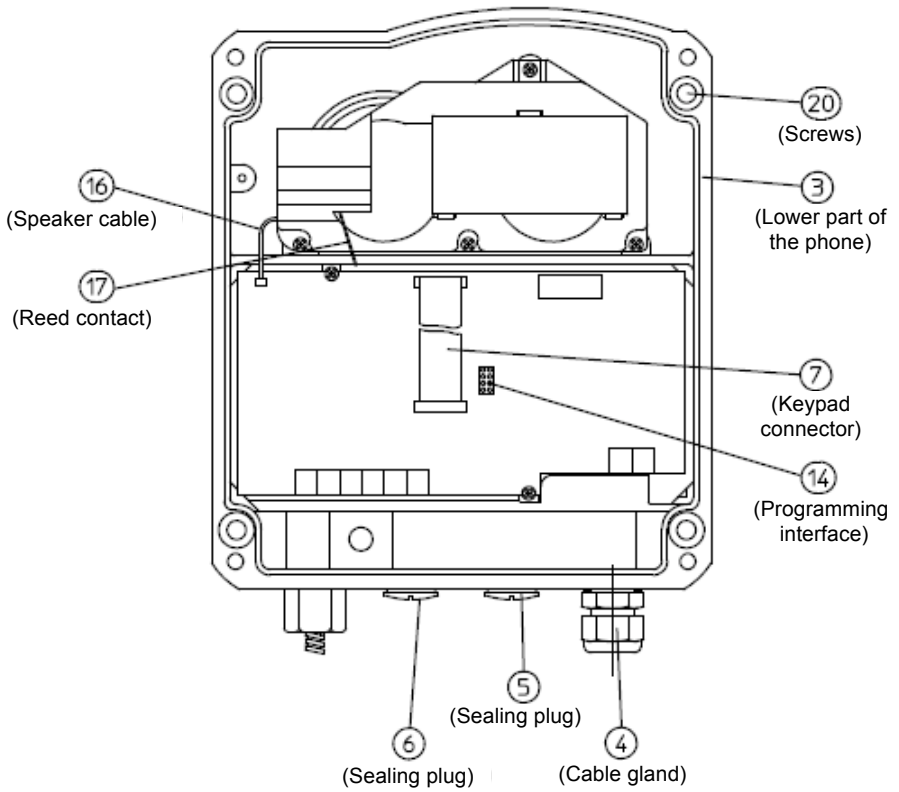

Label field

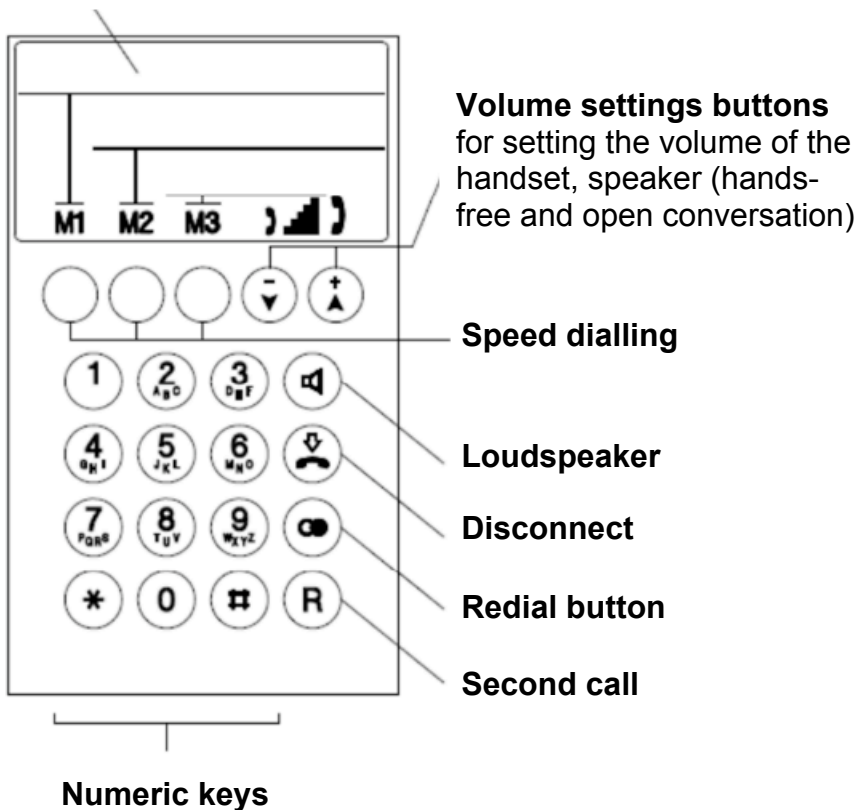

Package contents

The package contains:

- ResistTel MB phone
- Operating manual
- 2 sticky label panels
- MB sticker

Assembly and installation

The device can be installed only on a solid and vertical wall. Loosen the screws of the cover (2) (see the overview of the device on page 5 to 7) and take off the top part of the phone (1). When using the optional accessories: headset or second headset, mount the hook (10) with two screws (11) on the rear side of the lower part of the phone (In case of the above accessories, the hook and the screws and also in case of all optional accessories the cable gland is included in the respective package). Insert four screws with a head diameter of 10 to 13 cm in the opening (20) and mount the lower part of the phone (3) on the wall or a panel.

Insert the phone wire through the cable gland (4) and connect it to the clamps 13 and 14 (A, B) according to the wiring plan. Only use wires with an outer diameter of 5 to 9 mm, the IP66 rating of the device cannot be otherwise guaranteed.

Connecting the secondary sounder (for W conductor) (optional accessory)

Remove the sealing plug (5) and screw in the M20x1.5 cable gland completely. Insert the wire of the secondary sounder through the cable gland and connect it to the clamps 15 and 16 (Bell shunt 1, Bell shunt) according to the wiring plan. Only use wires with an outer diameter of 5 to 9 mm, the IP66 rating of the device cannot be otherwise guaranteed.

Connecting the speaker (optional accessory)

Remove the sealing plug (6) and screw in the M20x1.5 cable gland completely. Insert the wire of the speaker through the cable gland and connect it to the clamps 11 and 12 (SPK+, SPK-) according to the wiring plan. Only use wires with an outer diameter of 5 to 9 mm, the IP66 rating of the device cannot be otherwise guaranteed.

Connecting the headset (optional accessory)

Remove the sealing plug (6) and screw in the M20x1.5 cable gland completely. Insert the cable with the headset socket (included in the package of the FHF headset) through the cable gland and connect it to clamps 5 to 10 (HSM+, HSM-, HSR+, HSR-, HSS1, HSS2) according to the wiring plan. Only use the cable included in the package of the headset, because the IP66 rating of the device cannot be guaranteed.

Connecting the second headset (optional accessory)

Remove the sealing plug (6) and screw in the M20x1.5 cable gland completely. Insert the wire of the second headset through the cable gland and connect it to the clamps 7 and 8 (HSR+, HSR-) according to the wiring plan.

Check the correct position of the cover seal prior to assembly. Connect the ribbon cable with the connector (7) to the pin header (8) in the upper part of the device. Mount the upper part of the phone and fasten it with four cover screws (2) to the lower part of the phone.

When optional accessories are removed, close the openings created with the appropriate sealing plugs.

Wiring diagram

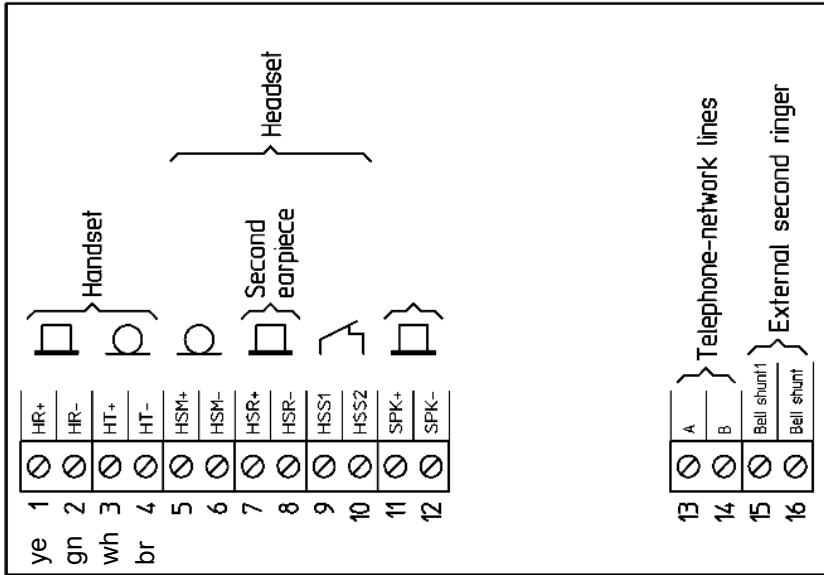

Support hook

The support force for holding the handset is infinitely adjustable. Loosen the screws (**12**) and slide the snap-in hook (**13**). If you slide the snap-in hook together, the support force increases, if you slide them apart, the force decreases. Tighten the screws again.

Hole pattern

Please use the following dimensions (in millimetre) for making a drilling template:

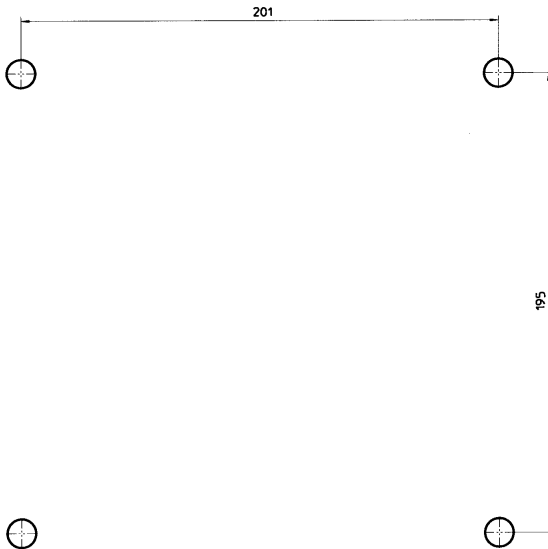

The diameter of the hole depends on the screws used (max. screw diameter 8 mm) and the type of the surface (steel, wood, concrete, sheetrock etc.) and please select accordingly.





Putting into service

The ResistTel MB phone is ready for operation immediately after connecting it to the network.





Maintenance

The ResistTel MB phone does not contain any components requiring maintenance.





Handset operation

If you lift the handset, the phone starts in handset mode. You can modify the handset volume for the conversation using the  and  buttons. For a permanent modification of the handset volume, please access the configuration of the phone (see page 17). You can switch to open listening with the  button. Hold down the  button and put the handset back to switch to hands-free mode.

Open listening

You can modify the volume for open listening using the  and  buttons. For a permanent modification of the open listening volume, please access the configuration of the phone (see page 17). The handset volume cannot be modified in open listening mode. You can switch to handset mode with the  button. Hold down the  button and put the handset back to switch to hands-free mode.

Hands-free mode



If you turn on the ResistTel MB phone with the  button, it starts up in hands-free mode. You can modify the speaker volume of the conversation using the  and  buttons. For a permanent modification of the speaker volume, please access the configuration of the phone (see page 17). You can end the conversation with the  button. If you lift the handset, the phone switches to handset mode.

Using the headset

If the headset is connected, the phone switches from open conversation to headset mode. Open conversation is therefore not possible with the headset. If you turn on the ResistTel MB phone with the  button, it starts up in headset mode. If you lift the handset in the headset mode, the handset is given priority. This means that you can listen and speak using the headset, and you can only listen with the headset.

Compare the operation without and with the headset connected:

Operation without the headset	Operation with the headset
Handset operation	Handset operation with the headset <ul style="list-style-type: none">- Handset is used for speaking and listening- headset is used for listening only- Speaker is turned off
Open listening	Open listening with the headset <ul style="list-style-type: none">- Handset is used for speaking and listening- headset is used for listening only- Speaker is turned on
Hands-free mode	Headset mode <ul style="list-style-type: none">- Handset is placed back- headset is used for speaking and listening- Speaker is turned off

You can modify the headset volume of the conversation using the  and  buttons. For a permanent modification of the headset volume, please access the configuration of the phone (see page 17). You can end the conversation with the  button.

You can specify the operation of the ResistTel MB phone after disconnecting the headset in the configuration.

Receiving calls

Calls received are indicated with acoustic signals of the built-in speaker. If the external speaker is connected and activated, the external speaker is used for acoustic signalling. Lift the handset to establish the connection with the caller. For activating the hands-free mode or headset mode press the speaker button instead.

Making a call

Lift the handset, and you can hear the dial tone (dial ready tone) of the public network or of the PBX network respectively.

Press the speed dialling button or the redial button or use the numeric keys to select the phone number of the other party automatically or manually.

Instead of lifting the handset, you can press the speaker button to make a call in open conversation or headset mode.

For selecting a new phone number, you do not need to place the handset back, you can press the disconnect button. The present conversation is ended and you can hear the dial tone to select a new phone number.

Redialling

If you press the redial button, the phone selects the last phone number dialled after lifting the handset or pressing the speaker button.

Making a second call

During the conversation, you can disconnect and place the present conversation on hold to make a second call with a different party. Press the second call button and you will hear the dial tone. Dial the phone number of the second party. After ending the second call, you can return to the first call on hold by pressing the second call button again. You can also connect the two parties of the first and second call with each other: Place the handset back or press the speaker button in hands-free or headset mode.

Making a second call is an additional service of the network operator or of the PBX you use.

Changing the phone settings

The phone is fitted with a programmable memory which permanently stores the settings like dialled numbers, volume settings, time data etc. These settings are adjustable to ensure that the phone can be adapted to diverse operating conditions.

All adjustable settings of the phone configuration are presented in the Configuration section below.

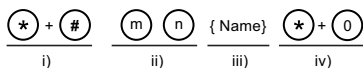

v) Name: = $0 \mid 1 \mid 2$

i) All modifications are made by pressing the \ast and $\#$ buttons at the same time.

The setting is selected for modification with the ii) buttons, and the settings range is shown by the symbolic name iii).

The additional row v) contains the list of buttons which can be used here.

If pressing the iv) buttons \ast and 0 at the same time, the configuration is ended and the modified settings are stored in the memory.

The symbolic name is enclosed with $\{ \}$ brackets, and 0 , 1 or several buttons of the list v) can be pressed, otherwise the user can press exactly one button.

Signal tones

_____	Acknowledgement sound
- - - - -	Error sound
■ ■ ■	PIN-Ping, Request to introduce the PIN number
-	Indication sound, selected speed dialling memory is not empty

Setting the ringer volume

*+#[1][0] { Volume } *+0
Volume:= [1][2][3][4][5][6][7]

Factory setting: 7
Settings range: 1 – 6

Selecting a ringtone

*+#[1][1] { Tune } *+0
Tune:= [0][1][2][3][4][5][6][7][8][9]

Factory setting: 0
Selection range: 0 - 9

Setting the handset volume

*+#[2][0] { Handset volume } *+0
Handset volume:= [1][2][3][4][5][6][7]

Factory setting: 1
Settings range: 1 - 7

Setting the speaker volume for open listening

*+#[2][2] { Open listening volume } *+0
Open listening volume:= [1][2][3][4][5][6][7]

Factory setting: 5
Settings range: 1-7

Setting the volume for hands-free operation

*+#[2][4] { Hands-free volume } *+0
Hands-free volume:= [1][2][3][4][5][6][7]

Factory setting: 5
Settings range: 1 - 7

Setting the headset volume

*+#[2][6] { Headset volume } *+0
Headset volume:= [1][2][3][4][5][6][7]

Factory setting: 3
Settings range: 1 - 7

Setting or deleting phone numbers for speed dialling

$\textcircled{*} + \textcircled{\#}$ Speed dial button { Speed dial no. } $\textcircled{*} + \textcircled{0}$

Speed dial button:= M1|M2|M3| $\textcircled{*} + \textcircled{M1}$ | $\textcircled{*} + \textcircled{M2}$ | $\textcircled{*} + \textcircled{M3}$

Speed dial number:= $\textcircled{0}$ | $\textcircled{1}$ | $\textcircled{2}$ | $\textcircled{3}$ | $\textcircled{4}$ | $\textcircled{5}$ | $\textcircled{6}$ | $\textcircled{7}$ | $\textcircled{8}$ | $\textcircled{9}$ | $\textcircled{*}$ | $\textcircled{\#}$

Factory setting: Memory empty

Maximum phone number length: 32 digits

$\textcircled{*} + \textcircled{\#}$ Speed dial button $\textcircled{*} + \textcircled{0}$

The selected speed dialling memory will be deleted.

Setting the call procedure

$\textcircled{*} + \textcircled{\#}$ $\textcircled{5}$ $\textcircled{0}$ { Call procedure } $\textcircled{*} + \textcircled{0}$

Call procedure:= || $\textcircled{1}$ | $\textcircled{2}$ | $\textcircled{3}$ | $\textcircled{4}$ | $\textcircled{5}$

$\textcircled{1}$ Tone dialling procedure: Tone as long as button is pressed down

$\textcircled{2}$ Tone dialling procedure: Tone length 70 ms

$\textcircled{3}$ Tone dialling procedure: Tone length 90 ms

$\textcircled{4}$ Impulse dialling procedure: Impulse/Pause ratio 1.5:1

$\textcircled{5}$ Impulse dialling procedure: Impulse/Pause ratio 2:1

Factory setting: 3

Storing or deleting a trunk access code

$\textcircled{*} + \textcircled{\#}$ $\textcircled{6}$ $\textcircled{0}$ { Trunk access code } $\textcircled{*} + \textcircled{0}$

Trunk access code:= $\textcircled{0}$ | $\textcircled{1}$ | $\textcircled{2}$ | $\textcircled{3}$ | $\textcircled{4}$ | $\textcircled{5}$ | $\textcircled{6}$ | $\textcircled{7}$ | $\textcircled{8}$ | $\textcircled{9}$ | $\textcircled{*}$ | $\textcircled{\#}$

Factory setting: no trunk access code

Maximum length of trunk access code: 5 digits

$\textcircled{*} + \textcircled{\#}$ $\textcircled{6}$ $\textcircled{0}$ $\textcircled{*} + \textcircled{0}$

The trunk access code will be deleted.

Setting the length of pause after dialling a trunk access code

$\textcircled{*} + \textcircled{\#}$ $\textcircled{6}$ $\textcircled{4}$ { Trunk access code pause } $\textcircled{*} + \textcircled{0}$

Trunk access code pause:= $\textcircled{1}$ | $\textcircled{2}$ | $\textcircled{3}$ | $\textcircled{4}$ | $\textcircled{5}$

$\textcircled{1}$ 1 s

$\textcircled{2}$ 2 s

$\textcircled{3}$ 3 s

$\textcircled{4}$ 4 s

$\textcircled{5}$ 5 s

Factory setting: 3

Setting the duration of a loop current interruption (flash time) when pushing the second call button ®

*+Ⓢ ⑥⑤ { Flash time } *+①

Flash time:= ①|②|③

① 80 ms

② 120 ms

③ 600 ms

Factory setting: 2

Activating/deactivating the change lock

*+Ⓢ ⑦① PIN { change lock } *+①

Change lock:= ①|①

① Change lock deactivated, all settings can be modified

① Change lock activated, settings are locked

Factory setting: 0

Setting the PIN number

*+Ⓢ ⑦① PIN { new PIN } { new PIN } *+①

PIN:=①①①①

New PIN:= ①|①|②|③|④|⑤|⑥|⑦|⑧|⑨|*|Ⓢ

Factory setting: 0000

PIN length: always 4 digits

If you modify the PIN number, be careful not to forget the PIN you have set. Forgetting the PIN number is similar to losing a key. If you forgot the PIN number, please contact our technical support service.

Technical support service in Germany, Mülheim an der Ruhr:

Phone number 0208 82 68 0

Fax 0208 82 68 286

E-mail info@fhf.de

Please use the country code if calling from outside Germany:

Phone number +49 208 82 68 0

Fax +49 208 82 68286

Activating/deactivating the external speaker

*+#+40 { ext. speaker } *+0

Ext. speaker:= 0|1

0 External speaker deactivated

1 External speaker activated

Factory setting: 0

Restoring factory settings

*+#+90 PIN *+0

PIN:=0000

Setting the procedure when disconnecting the headset

*+#+28 { Optional headset } *+0

Optional headset:= 0|1

0 Disconnect (hang up) if the headset is disconnected
in case of headset mode activated.

1 Maintain the connection if the headset is disconnected
in case of headset mode activated.

Factory settings

The device is set for general conditions of use to ensure that it can be used immediately after connecting it.

These preliminary settings can be modified according to your personal requirements and connection conditions in the configuration settings.

The following preliminary settings are included in the factory settings of the device:

- Ring tone volume 7 (maximum)
- Ring tone tune 0
- Speaker volume 1 (normal speaker volume)
- Speaker volume for open listening 5
- Speaker volume for hands-free operation 5
- Headset volume 3
- Redialling deleted
- Speed dialling memory deleted
- Call procedure: tone dialling with 90 ms tone length
- Trunk access code deleted
- Dialling pause after trunk access code 3 seconds
- Flash duration 120 ms
- Modification lock deactivated
- PIN 0000
- External speaker: deactivated
- Optional headset 0

Technical Data

Connection data	
Supply voltage	24 V _{DC} up to 66 V _{DC}
Supply current	15 mA _{DC} up to 100 mA _{DC}
Ringing alternating current	24 V _{AC} up to 90 V _{AC} (at 21...54 Hz ring tone frequency) 30 V _{AC} up to 90 V _{AC} (at 16.6...54 Hz ring tone frequency)
Tone call impedance	Over 6.0 kΩ at 25 Hz and 24...90 V _{AC} Over 4.0 kΩ at 50 Hz and 24...90 V _{AC}
Second call button	Flash length can be selected from 80 ms, 120 ms and 600 ms
Dialling procedure	Tone dialling and impulse dialling Tone dialling according to ITU-T Q.23. Impulse dialling at an impulse to pause ratio of 1.5:1 or 2:1
Trunk access code	One trunk access code, maximum 5 digits
Dial pause after trunk access code	1 s up to 5 s
W conductor	For connecting an external secondary sounder
External speaker	Clamps for connecting an external speaker (optional accessory)
Headset	Clamps for connecting a headset. (optional accessory) Note: You can connect a headset or a second headset, but not both at the same time!
Second headset	Clamps for connecting a second headset (optional accessory) Note: You can connect a headset or a second headset, but not both at the same time!
Connection terminals	Up to 4 mm ² rigid Up to 2.5 mm ² flexible
Housing	
Material	Fibreglass reinforced polyester
Height x Width x Depth	cca. 260 mm x 228 mm x 135 mm
Weight	cca. 5.5 kg
Keypad	- Metal keypad protected against icing - 21 keys with the appropriate inscription
Operating position	Vertical wall-mounted. The device can be installed only on a level surface.

Handset	
Support hook protection	Integrated, adjustable support hook protection
Handset cord	Steel-reinforced armoured cord made of stainless steel
Earphone	Dynamic earphone with a stray field coil for the inductive connection of hearing aid devices
Mouthpiece	Electret microphone
Noise cancellation	Over 3 dB with the integrated speaking funnel
Environmental conditions	
Protection rating:	IP66 according to EN60529
Protection against mechanical wear:	Protection rating IK09 according to EN50102
Operating temperature:	-25°C to +60°C
Storage temperature:	-25°C to +70°C
Other characteristics	
Disconnect button	Separate button
Hook switch	Reed contact without a mechanical hook
Supply	From the analogue phone network No additional power supply required
Call-charge impulse lock	- Electrical damping for 12 kHz and 16 kHz at the earphone of over 30 dB related to 1 kHz - Impedance (at the phone connections A, B): cca. 13 k Ω (1 V _{eff} ; 12 kHz; idle state) cca. 4 k Ω (10 V _{eff} ; 12 kHz; idle state) cca. 2.5 k Ω (1 V _{eff} ; 12 kHz; conversation state) cca. 2.3 k Ω (10 V _{eff} ; 12 kHz; conversation state) cca. 11 k Ω (1 V _{eff} ; 16 kHz; idle state) cca. 4 k Ω (10 V _{eff} ; 16 kHz; idle state) cca. 2.5 k Ω (1 V _{eff} ; 16 kHz; conversation state) cca. 2.3 k Ω (10 V _{eff} ; 16 kHz; conversation state)
Ring tone volume	- cca. 95 dB(A) at 1 m distance and 50 V _{AC} / 50 Hz Factory setting. (The maximum volume depends also on the selected tune and the feeding conditions.) 6 levels can be selected including muted (The ring tone volume is reduced by approx. 13 dB(A) when the optional external speaker is turned on.)
Ring tone tunes	10 tunes can be selected

Speaker volume for open listening	<ul style="list-style-type: none"> - maximum volume is approx. 70 dB(A) at 1 m distance - 7 levels can be selected permanently or temporarily (The speaker volume is reduced if the optional external speaker is connected.)
Speaker volume for hands-free operation	<ul style="list-style-type: none"> - Operation in case of environmental noise of up to 70 dB(A) (in case of high noise level, communication with the hands-free is not possible.) - maximum volume is approx. 70 dB(A) at 1 m distance - adjustable in 7 levels permanently or temporarily. (The speaker volume is reduced if the optional external speaker is activated.)
Handset volume	<ul style="list-style-type: none"> - Handset volume between 0 db and +12 db - adjustable in 7 levels permanently or temporarily
Headset volume	<ul style="list-style-type: none"> - adjustable in 7 levels permanently or temporarily
Signal tones	<ul style="list-style-type: none"> - Signal tone in case of successful or incorrect configuration, when requesting the PIN number and changes of data stored in the memory

Directives and standards	
Conformity wit the following directives and standards:	<ul style="list-style-type: none">- R&TTE Directive 1999/5/EC- Low Voltage Directive 73/23/EEC- EMC Directive RL89/336/EC for residential and Industrial areas- ETSI TBR 38: May 1998- ETSI TS103021-1 (2004-05)- ETSI TS103021-2 (2004-11)- ETSI TS103021-3 (2003-08)

Service

You acquired a modern product manufactured by **FHF** which was subject to a strict quality assurance process. If you have any questions concerning the phone, or in the event of a fault, even after the warranty period, please contact **FHF** (see page 4). Please keep the type number and item number at hand (you can find these code numbers on the rating plate).

Care and Maintenance

The telephone is maintenance free. However, if the phone is used in areas with heavy pollution with dust, grease, oil etc. it should be cleaned regularly. Wipe the handset and the device with a damp cleaning cloth. **Attention!** Never use sharp objects for cleaning.

Disposal

The device is disposed of as electronic waste.
Plastic, metal and electronic parts are to be disposed of separately upon disassembly.
The requirements concerning disposal of the country of application are to be observed.

Warnings and safety instructions

This is a weatherproof phone specifically developed for use in rough industrial conditions. Please observe the following warnings and safety instructions:

1. The phone is manufactured to comply with protection class II and can only be connected and operated with the specified voltage. Ensure correct connection of the device. The connecting wire shall be routed not to cause a tripping hazard.
2. The phone may only be operated under the above-mentioned environmental conditions (see Technical data). Adverse environmental conditions, for example environmental temperature too high or too low are not permitted because they can cause the breakdown of electronic components.
3. Care must be taken to ensure that the phone and the connecting wires etc. are not damaged. Do not use the phone if damaged.
4. For the operation of the phone, legal and industrial requirements, regulations for the prevention of accidents and electrical specifications must be observed.
5. Use only original parts for repair, which were replaced professionally. Other replacement parts can cause damage and it will void the warranty.
6. Cut off the power supply before performing maintenance works or replacement of the phone. If repair or maintenance work must be performed under power, they can only be performed by professionals.

7. Requirements on the position of the device must be met. The device can only be mounted vertically on a flat area.
8. Power frequency magnetic fields can have a slight influence on the sound quality. Please take care to select the correct place of installation in this case.
9. Dust must not enter the device while it is open!
10. The cover seal and the collar of the lower part of the housing required for the tightness of the housing cannot be damaged during assembly or disassembly.
11. A rust film can form in case of a high concentration of sulphurous gases in the air.
12. We reserve the right to modify the product for its technical development without preliminary notice.

CE marking

The ResistTel MB phone complies with the following directives:

R&TTE Directive 1999/5/EC

Low Voltage Directive 2006/95/EC

EMC Directive 2004/108/EC

RoHS Directive 2011/65/EC

The CE marking is proof of conformity with the above specified directives.

Subject to alterations or errors



FHF Funke + Huster Fernsig GmbH

Gewerbeallee 15-19 · D-45478 Mülheim an der Ruhr
Phone +49/208/82 68-0 · Fax +49/208/82 68-286
<http://www.fhf.de> · e-mail: info@fhf.de

www.malux.se