

CT1/6U-CT2/8U TELEPHONE SWITCHBOARDS



USER GUIDE



02.2008/2406-6122 A

TELEPHONE SWITCHBOARDS
CT1/6U-CT2/8U

USER GUIDE

Congratulations on your purchase of switchboard CT1/6U-CT2/8U. You are now the owner of a truly comprehensive system designed to meet your business and home. To get the most out of your switchboard, exploiting its features and functions to the full, we suggest you read this manual carefully and keep it handy for future reference.

***WARNING.** Work inside the set should be performed by qualified technical personnel only.*

BPT S.p.A.,

based in Italy in Via Roma, 41
30020 Cinto Caomaggiore VE,

hereby declares on its own responsibility that the switchboards conform to the standards given below.

Electromagnetic compatibility

(EMC directive 89/336/CEE)

- emission EN 55022, EN 61000-3-2, EN 61000-3-3;
- immunity EN 55024, EN 61000-4-2, EN 61000-4-3, EN 61000-4-4, EN 61000-4-5, EN 61000-4-6, EN 61000-4-8, EN 61000-4-11.

Electrical safety

(LVD 73/23/CEE)

- EN 60950.

Directive 1999/5/EC on radio equipment and telecommunications terminal equipment and the mutual recognition of their conformity.

- TBR 21, EG 201 121, ES 201 187, ETS 300 778-1.

CONTENTS

Foreword	4	Special functions	21
BPT telephone receivers	6	- Prime line call	21
Standard functions	9	- General address call	21
- Call on local line	9	- Workgroup broadcast	22
- Answering incoming calls	9	- Temporary override of direct distance dialling restriction	22
- Last local number redial	9	- Paging call with 8 call codes	23
- Call to other receivers	9	- Barge-in	23
- Call hold and retrieval	10	- 3-way conferencing (2 internal and 1 external)	24
- Consultation hold	10	- Call rerouting	24
- Interlocutor switching	10	- Activating follow-me feature	25
- Call transfer	11	- Clock alarm/reminder	25
- Answering call from the entry panel during a conversation	11	- DAY/NIGHT mode	26
- Pickup of local telephone call or call from entry panel for absent receiver	12	DISA functions	27
Standard audio entry control functions ..	13	- Activation of local telephone call rerouting to stored external number (for CT2/8U only)	27
- Door lock release command 1	13	- Executing auxiliary command P1 via local line	28
- Auxiliary command 1	13	- Executing of auxiliary command P2 via local line	28
- Self-connection and switching between entry panels	14	- Call pickup for call on given unattended receiver	29
Useful functions	15	- Password-protected unrestricted dialling on outside line (for CT2/8U only)	29
- Using general speed dialling	15	Accessories	30
- Using dedicated speed dialling	15	Tones and ringing patterns	31
- Activating HOTLINE	15	Index	32
- Call rerouting from entry panel to local line	16		
- Callback feature: outside line queuing or busy receiver callback ..	17		
- Local line call park to change receiver	17		
- Privacy (do-not-disturb feature)	18		
- Automatic alarm message to stored external telephone number	18		
- Auxiliary commands P1 and P2	19		
- Door lock release command 2	20		
- Additional services supplied by the telephone company	20		

FOREWORD

Telephone switchboards CT1/6U and CT2/8U enable up to 6 or 8 telephone sets respectively to be used for intercom functions and to access one or two telephone lines. Suitable interface cards can be employed to connect the switchboard to an audio or video entry control installation, with such options as door lock release, self-connection to entry panels to monitor entrances and other auxiliary commands.

- The CT1/6U telephone switchboard can handle 6 receivers and 1 outside line plus 1 optional GSM line.
- The CT2/8U telephone switchboard can handle 8 receivers and 2 outside lines plus 1 optional GSM line.

The following optional cards can be employed to implement the switchboard's additional features:

CTI/200 - interface card for series-200 audio and video entry control installations for managing two calls, two door lock release commands and up to three auxiliary commands;

CTI/300 - interface card for series-300 audio and video entry control installations for managing two calls, one door lock release command and up to four auxiliary commands;

CTI/304 - video interface card for series-300 video entry control systems;

CTI/GSM - GSM card with antenna for use in managing a local telephone line (GSM);

CTM/... - music card (various melodies);

CTM/GV - music card with voice guide with 4 voice prompts and announcements;

FOREWORD

Types of calls possible with the switchboard

- 1 - Telephone call on local line.
- 2 - Communication with entry panel.
- 3 - Call between internal telephone.
- 4 - Communication between entry panel and local line.
- 5 - Telephone call on local line rerouted to stored external number (with CT2/8U only).
Password-protected unrestricted dialing on outside line (with CT2/8U only).

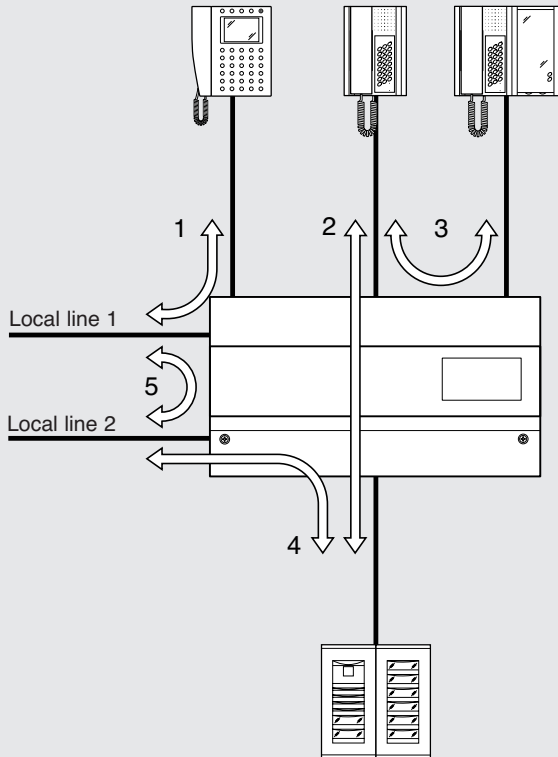





BPT TELEPHONE RECEIVERS



XT/200

The telephone features commands that can be used when connected to BPT system-200, 300 and X2 audio entry installations.

If the receivers' commands associated with audio entry functions (e.g. door lock release) are not working properly, get in touch with BPT's Technical Support to have the set's version checked.

Command description	Dedicated key	Key-in command	
		System 200	System 300 and X2
Door lock release 1 (●)		(R) (5) (0)	(R) (*) (5) (0)
Self-connection to entry panel	-	(*) (5) (2)	-
Self-connection/entry panel switching	-	-	(*) (5) (2) / (R) (*) (5) (2)
Auxiliary 1/entry panel switching (●)		(R) (5) (3)	-
Auxiliary 1		-	(R) (*) (5) (3)
Porter call 1 (auxiliary P1)		(R) (*) (5) (4)	(R) (*) (5) (4)
Interlocutor switching		(R) (4) (4)	(R) (4) (4)
Door lock release 2 (●)	-	(R) (5) (1)	-
Auxiliary 3	-	-	(R) (*) (5) (1)
Porter call 2 (auxiliary P2)	-	(R) (*) (5) (5)	-
Auxiliary 4	-	-	(R) (*) (5) (5)

(●) Enabled with audio communication with entry panel in progress.







BPT TELEPHONE RECEIVERS



XT/200+XV/200 XT/200+XVC/200

The receivers feature commands that can be used when connected to BPT system-200, 300 and X2 video entry installations.

If the receivers' commands associated with video entry functions (e.g. door lock release, self-connection to entry panel etc.) are not working properly, get in touch with BPT's Technical Support to have the set's version checked.

Command description	Dedicated key	Key-in command	
		System 200	System 300 and X2
Door lock release 1(●)		R 5 0	R * 5 0
Self-connection to entry panel		* 5 2	-
Self-connection/entry panel switching		-	* 5 2 / R * 5 2
Auxiliary 1/entry panel switching (●)		R 5 3	-
Auxiliary 1		-	R * 5 3
Porter call 1 (auxiliary P1)		R * 5 4	R * 5 4
Interlocutor switching		R 4 4	R 4 4
Door lock release 2 (●)	-	R 5 1	-
Auxiliary 3	-	-	R * 5 1
Porter call 2 (auxiliary P2)	-	R * 5 5	-
Auxiliary 4	-	-	R * 5 5

(●) Enabled with audio communication with entry panel in progress.

BPT TELEPHONE RECEIVERS



IMT/200-IMTC/200







Receivers for use in BPT system-200 video entry control installations.

IM/T-IM/TC

Receivers for use in BPT system-300 and X2 video entry control installations.

The receivers feature commands that can be used when connected to BPT video entry installations.

If the receivers' commands associated with video entry functions (e.g. door lock release, self-connection to entry panel etc.) are not working properly, get in touch with BPT's Technical Support to have the set's version checked.

Command description	Dedicated key	Key-in command	
		System 200	System 300 and X2
Door lock release 1 (●)		(R) (5) (0)	(R) (*) (5) (0)
Self-connection to entry panel		(*) (5) (2)	-
Self-connection/entry panel switching		-	(*) (5) (2) / (R) (*) (5) (2)
Auxiliary 1/entry panel switching (●)		(R) (5) (3)	-
Auxiliary 1		-	(R) (*) (5) (3)
Porter call 1 (auxiliary P1)		(R) (*) (5) (4)	(R) (*) (5) (4)
Interlocutor switching		(R) (4) (4)	(R) (4) (4)
Door lock release 2 (●)	-	(R) (5) (1)	-
Auxiliary 3	-	-	(R) (*) (5) (1)
Porter call 2 (auxiliary P2)	-	(R) (*) (5) (5)	-
Auxiliary 4	-	-	(R) (*) (5) (5)

(●) Enabled with audio communication with entry panel in progress.

STANDARD FUNCTIONS

Call on local line

All telephones connected to the switchboard are enabled to make calls on the local telephone line unless otherwise programmed (see programming manual, page 38).

Whatever the case, ALL receivers can access the outside line for dialling emergency numbers (e.g. 112, 113, 118, etc.) and speed dialling.



Lift the handset and wait for the dial tone.



Dial the desired telephone number on the keypad.



Replace the handset when the conversation is over.

NOTE. *The switchboard recognizes the number entered corresponding to a call on an outside line based on the European numbering scheme.*

In countries where this numbering scheme is not in effect, you will need to enter prefix $\textcircled{}$ $\textcircled{0}$ or $\textcircled{9}$ in front of the telephone number to get an outside line.*

Answering incoming calls



Lift the handset to answer the call and start conversation.



Replace the handset when the conversation is over.

WARNING. *The telephone may ring with the following patterns:*

- 1 s and 4 s pause for external call (fixed network or GSM);
- 0.6 s +0.2 s and 4 s pause for call from other extensions;
- 0.6 s +0.6 s and 3.6 s pause for call from entry panel.

Last local number redial

To redial the last number dialled, press button **RP**.

If the telephone does not feature the **RP** button, proceed as follows:



Lift the handset and wait for the dial tone.



Dial $\textcircled{*}$ $\textcircled{4}$ $\textcircled{5}$. The last local number is redialled.



Replace the handset when the conversation is over.

Call to other receivers



Lift the handset and wait for the dial tone.



Dial the number of the extension required ($\textcircled{5}$ $\textcircled{0}$ ÷ $\textcircled{5}$ $\textcircled{7}$).



Replace the handset when the conversation is over.

STANDARD FUNCTIONS

Call hold and retrieval

If you want to put the interlocutor on hold during a conversation, proceed as follows:

Dial **(R) (2)**. The interlocutor will hear the hold tone or music (optional card).

To resume conversation:

Dial **(R) (#)**.

Conversation can continue.

WARNING. *If you are talking with an internal receiver, you can only put the call on hold from the receiver the call was made from.*

Consultation hold

If, during a local telephone call or conversation with the entry panel, you want to put the interlocutor on hold to consult with a receiver, proceed as follows:

Dial **(R) (2)**. The interlocutor will hear the hold tone or music (optional card).

Dial the number of the receiver you want to consult with (**(5) (0)** ÷ **(5) (7)**).

To resume conversation on the outside line, wait for receiver consulted to hang up, or

Dial **(R) (#)**.

Interlocutor switching

If you already have a call on hold and you are talking with another interlocutor, you can alternate between the first interlocutor and the second. The interlocutor can be another receiver or an external caller without distinction.

Proceed as follows:

Dial **(R) (4) (4)** during a conversation in progress whilst you have another interlocutor on hold to alternate between the two. The interlocutor you are not talking with will hear the hold tone or music (optional card).

Dial **(R) (#)** to end the conversation in progress and resume communication with the other interlocutor.



Replace the handset when the conversation is over.

Press the  button on **bpt** telephones to switch from one interlocutor to another.

STANDARD FUNCTIONS

Call transfer

To transfer a call in progress to another receiver, proceed as follows:



Dial **(R) (2)**. The interlocutor will hear the hold tone or music (optional card).



Dial the number of the receiver the call is to be transferred to (**(5) (0) ÷ (5) (7)**).

If the receiver called is free



Replace the handset to transfer the call without announcing it.

If the called receiver does not answer after 30 s, the call put on hold is returned to the telephone it was transferred from.

or

Wait for an answer and announce the call.



Replace the handset to transfer the call.

If the receiver called is busy



Dial **(R) (#)** to return to the interlocutor put on hold.

or



Dial **(R) (4) (2)** to barge in on the conversation in progress (see page 23).

or



Dial **(R) (4) (7)** to transfer the call to the busy extension.



Replace the handset.

If the called receiver does not answer after 30 s, the call put on hold is returned to the telephone it was transferred from.

Answering a call on the outside line or call from the entry panel during a conversation

If, during a conversation, you hear the call waiting tone (on your own telephone) or another telephone rings to indicate that there is a call coming in on the local line or from the entry panel, you can answer the call proceeding as follows:



Dial **(R) (2)**. The interlocutor will hear the hold tone or music (optional extra).



Dial **(*) (4) (1)** once you hear the dial tone to answer the external call. You can now converse with the second interlocutor.



Dial **(R) (2)** to put the second interlocutor on hold and then **(5) (0) ÷ (5) (7)** for any extension the second interlocutor is to be transferred to.

or



Dial **(R) (#)** to hang up with the second interlocutor and resume conversation with the first.

STANDARD FUNCTIONS

Pickup of local telephone call or call from entry panel for absent receiver

If your telephone is not ringing, you can answer a call being made to another set.

Proceed as follows:



Lift your telephone's handset.



Dial * 4 1 to answer the call.



Replace the handset when the conversation is over.

STANDARD AUDIO ENTRY FUNCTIONS

Door lock release command 1

The door lock release command is only enabled when communication with the entry panel is active. The system is activated following a call from the entry panel or using the self-connection feature (see coming section).

If you are connected to a system-200 installation and want to use the door lock release feature:



Dial (R) 5 0 to send the door lock release command.
Press the  button on **bpt** telephones to send the door lock release command.



Replace the handset.

WARNING. If connection with the entry panel is not active and your dial (R) 5 , you will end up calling receiver 50.

Or

If you are connected to a system-300 installation and want to use the door lock release feature:



Dial (R) * 5 0 to send the door lock release command.
Press the  button on **bpt** telephones to send the door lock release command.



Replace the handset.

Auxiliary command 1

With card CTI/... installed, you can send a central auxiliary command.

If you are connected to a system-200 installation, execute this pulse-type command lasting 1 s – only when connection with the entry panel is active – proceeding as follows:



Dial (R) 5 3 .

Press the  button on **bpt** telephones.

WARNING. If connection with the entry panel is not active and you dial (R) 5 3 , you will end up calling receiver 53.

If you are connected to a system-300 installation, execute this command proceeding as follows:



Lift the handset and wait for the dial tone.



Dial (R) * 5 3 .

Press the  button on **bpt** telephones.

This command may be enabled even when connection with the entry panel is not activate.

STANDARD AUDIO ENTRY FUNCTIONS

Self-connection and switching between entry panels

The entry panel can be activate to monitor the entrance with the aid of audio and images, or to send the door lock release and a number of auxiliary commands, in video entry control installations.

Proceed as follows:



Lift the handset and wait for the dial tone.



Dial * 5 2 to communicate with the entry panel.

Press the  button on **bpt** audio/monitor/telephone stations for self-connection to the entry panel.

If the installation features other entry panels (e.g. a second entrance), you can connect with them by switching between panels.

If you are connected to a system-200 installation, once communication is activated proceed as follows:



Dial R 5 3. Every time this code is repeated, you switch to another entry panel.



Press the  button on **bpt** telephones to switch between entry panels.

WARNING. If connection with the entry panel is not active and you dial R 5 3, you will end up calling receiver 53.

If you are connected to a system-300 installation, once communication is activated proceed as follows:



Dial R * 5 2. Every time this code is repeated, you switch to another entry panel.

Press the   button on **bpt** audio/monitor/telephone stations to switch between the entry panels.

USEFUL FUNCTIONS

General speed dialling

The 50 general speed dial numbers can be used by all receivers regardless of any direct distance dialling restrictions assigned (see programming manual, page 28).

Proceed as follows:



Lift the handset and wait for the dial tone.



Dial $(*) (4) (3)$ + the code corresponding to the general speed dial number wanted ($(0) (0) \div (4) (9)$).



Replace the handset when the conversation is over.

Dedicated speed dialling

The 15 personal speed dial numbers (see programming manual, page 28), specific for each receiver, can be used at any time, even when direct distance dialling restrictions are enabled.

Proceed as follows:



Lift the handset and wait for the dial tone.



Dial $(*) (4) (4)$ + the code corresponding to the personal speed dial number wanted ($(0) (0) \div (1) (5)$).



Replace the handset when the conversation is over.

Activating HOTLINE

This function can be used to manage emergency situations.

When the handset is lifted and no number dialled for over 10 s, the receiver is automatically connected to the first free local line (speed dial number 49, see programming manual, page 28).

To activate the feature, proceed as follows:



Lift the handset of the receiver you want the HOTLINE feature to be activated on and wait for the dial tone.



Dial $(*) (7) (2) (1)$ to activate the HOTLINE feature.



Wait for the 3 acknowledgement tones and replace the handset.

To disable the feature:



Lift the handset of the receiver you want the HOTLINE feature to be disabled on and wait for the dial tone.



Dial $(*) (7) (2) (0)$ to disable the HOTLINE feature.



Wait for the 3 acknowledgement tones and replace the handset.

USEFUL FUNCTIONS

Call rerouting from entry panel to local line

A call from the entry panel can be rerouted to a stored external number (speed dial number 47, see programming manual, page 28).

This feature is useful if you want to answer a call from the entry panel with a remote telephone when you are away from the house or office. The length of conversation is controlled by the video or audio entry control installation's timer. To activate the feature, proceed as follows:



Lift the handset of receiver 50 only.



Dial * 9 2 1.



Wait for the 3 acknowledgement tones and replace the handset

or

if the switchboard is only connected to a mobile telephone system (CTI/GSM) and you want to activate call transfer



Dial * 9 2 2.



Wait for the 3 acknowledgement tones and replace the handset.

To disable the feature:



Lift the handset of receiver 50 only.



Dial * 9 2 0.



Wait for the 3 acknowledgement tones and replace the handset.

Once this function has been activated, from a remote telephone it is possible to communicate with an entry panel and also to give only commands P1 and P2 (see page 28 of the "User's Manual").

USEFUL FUNCTIONS

Callback feature: outside line queuing or busy receiver callback

A user of an extension finding that the outside lines assigned to it during programming are not free, or the extension called is busy, can activate the automatic callback feature proceeding as follows:



Dial **(R) 4 1** to activate queuing so that you will be called back as soon as an outside line is free, or to activate automatic callback by the busy receiver you are trying to call.



Wait for the 3 acknowledgement tones and replace the handset.

Outside line is free



When the call back comes in - with a ringing pattern of 3 rings lasting 0.2 s and a 4 s pause - lift your telephone's handset and wait for the dial tone.



Dial the desired number.



Replace the handset when the conversation is over.

Extension is free



When the call back comes in - with a ringing pattern of 3 rings lasting 0.2 s and a 4 s pause - lift the handset. You will hear the call control tone sent to the receiver the callback feature is activated on.



When the receiver answers, conversation can commence. Replace the handset when the conversation is over.

Local line call park to change receiver

This feature lets you put the interlocutor of a local line call on hold temporarily (up to 2 min) and to resume conversation via any other receiver.

Proceed as follows:



Dial **(R) 4 0** during a conversation in progress on the outside line.

The interlocutor will hear the hold tone or music (**optional card**).



Wait for 3 acknowledgement tones and replace the handset.



Lift the handset of any other receiver within 2 min and wait for the dial tone.



Dial **(*) 4 0** to retrieve the external call put on hold.



Replace the handset when the conversation is over.

USEFUL FUNCTIONS

Privacy (do-not-disturb feature)

The **do-not-disturb** feature lets you turn off your telephone's ring, and callers are answered with the busy tone.

To enable or disable, proceed as follows:



Lift your telephone's handset and wait for the dial tone.



Dial ***641** to disable your ring for any incoming calls.

Or



dial ***642** to disable your ring for calls on the local telephone line and from the entry panel only.

Or



dial ***643** to disable your ring for calls coming from other receivers only.

Or, to disable the feature



dial ***640**.



Wait for the 3 acknowledgement tones and replace the handset.

Automatic alarm message to stored external telephone number

With card CTI/... installed, you can manage sending of an alarm warning to a preset external telephone number (speed dial number **46**, see programming manual, page 28).

The person the alarm is sent to will receive a warning in the shape of a telephone call with an acknowledgement tone made up of 3 rings lasting 0.1 s each and a 1.5 s pause, or will receive a voice message if voice guide card CTM/GV has been installed (optional).

USEFUL FUNCTIONS

Auxiliary commands P1 and P2

With card CTI/... installed, two auxiliary commands are available.

These commands can be programmed for operation in pulse mode lasting 1 s, or in ON/OFF mode (see programming manual, page 43).

Executing command P1 in pulse mode (monostable)



Lift your telephone's handset and wait for the dial tone.



Dial **(R) (* 5 4)** to execute the command.

*Press the  button on **bpt** telephones to execute the command.*



Replace the handset.

Executing command P1 in ON/OFF mode (bistable)



Lift your telephone's handset and wait for the dial tone.



Dial **(R) (* 5 4 1)** to execute the command.



Replace the handset.

To disable the command:



Lift your telephone's handset and wait for the dial tone.



Dial **(R) (* 5 4 0)**.



Replace the handset.

The P1 command can also be executed from a remote phone when the DISA automatic answering function has been set (see programming manual, page 33).

Executing command P2 in pulse mode (monostable)



Lift your telephone's handset and wait for the dial tone.



Dial **(R) (* 5 5)** to execute the command.



Replace the handset.

Executing command P2 in ON/OFF mode (bistable)



Lift your telephone's handset and wait for the dial tone.



Dial **(R) (* 5 5 1)** to execute the command.



Replace the handset.

To disable the command:



Lift your telephone's handset and wait for the dial tone.



Dial **(R) (* 5 5 0)**.



Replace the handset.

The P2 command can also be executed from a remote phone when the DISA automatic answering function has been set (see programming manual, page 33).

USEFUL FUNCTIONS

Door lock release command 2

To execute this command, proceed as follows:

① ② ③
④ ⑤ ⑥
⑦ ⑧ ⑨

Dial **R** * **5** **1** to open the second entrance



Wait for the 3 acknowledgement tones and replace the handset.

This command is enabled even when connection with the entry panel is not active.

Additional services supplied by the telephone company

To use additional services supplied by the telephone company, proceed as follows:

① ② ③
④ ⑤ ⑥
⑦ ⑧ ⑨
⑩ ⑪ ⑫

If the command entails dialling an **R**, dial **R** **4** **5** instead.

For instance, if the command you are interested in is **R** **2**, you will have to dial **R** **4** **5** **2**.

① ② ③
④ ⑤ ⑥
⑦ ⑧ ⑨
⑩ ⑪ ⑫

If, on the other hand, it does not entail dialling an **R**, you will have to dial * **0** before the required sequence.

For instance, if the command you are interested in is * **6** **5** **#**, you will have to dial * **0** * **6** **5** **#**.

WARNING. The SMS service is not supported.

SPECIAL FUNCTIONS

Prime line call

If you want to seize a given outside line, proceed as follows:



Lift the handset and wait for the dial tone.



Dial * 1 1 to seize line 1.

Or



dial * 1 2 to seize line 2.

Or



dial * 1 3 to seize the GSM line (where this option is available).



Wait for the dial tone and dial the desired number.



Replace the handset when the conversation is over.

General address call

Any receiver can make a call to all free extensions. Proceed as follows:



Lift your telephone's handset and wait for the dial tone.



Dial * 6 0 to make a general address call to free receivers.



Once conversation with the receiver answering is over, replace the handset.

SPECIAL FUNCTIONS

Workgroup broadcast

Any receiver can make a call to all free receivers belonging to one of the 4 workgroups (see programming manual, page 27).

Proceed as follows:



Lift your telephone's handset and wait for the dial tone.



Dial **6 6 6 9** to make a general address call to all receivers in the group wanted.



Replace the handset when the conversation is over.

Temporary override of direct distance dialling restriction

Only people who know the system PASSWORD (see programming manual, page 24) can make a phone call from any receiver on which direct distance dialling has been disabled, overriding said restriction to make a single phone call.

Once the call ends, the restriction is automatically reapplied on the receiver.

Proceed as follows:



Lift the receiver and wait for the dial tone.



Dial *** 6 5** + the previously programmed 4 digit **PASSWORD**.



Wait for the 3 acknowledgement tones and replace the handset.



Lift the handset and wait for the dial tone.



Dial the desired telephone number.



Replace the handset when the conversation is over.

SPECIAL FUNCTIONS

Paging call with 8 call codes

Any receiver can make a call to all free receivers with 8 different call ringing patterns.

Proceed as follows:



Lift the handset and wait for the dial tone.



Dial $\textcircled{*} \textcircled{6} \textcircled{1} \textcircled{1} \textcircled{\div} \textcircled{6} \textcircled{1} \textcircled{8}$ to make a coded general address call, identifying the person you are looking for.
The telephone rings 1 s + $(1 \div 8) \times 0.5$ s with a 2 s pause.
The person being paged can answer from any receiver.



Replace the handset when the conversation is over.

Barge-in

This feature lets you intrude on a conversation in progress with another receiver or external caller in an emergency.

Proceed as follows:



Lift the handset and wait for the dial tone.



Dial $\textcircled{5} \textcircled{0} \textcircled{\div} \textcircled{5} \textcircled{7}$ (number of the receiver required).



Dial $\textcircled{R} \textcircled{4} \textcircled{2}$ when you hear the busy tone.
The barge-in feature is activated.



Once the conversation – accompanied by the barge-in warning tone – is over, replace the handset.

SPECIAL FUNCTIONS

3-way conferencing (2 internal and 1 external)

If you already have a call on hold and you are talking with another interlocutor, you can conference him/her in with the first.

The conferencing feature allows conversation between 1 outside line and 2 receivers or between 3 receivers at the same time.

Proceed as follows:



Dial **R 4 3** during the conversation in progress whilst you have another interlocutor on hold to activate 3-way conferencing.



Once the conference call – accompanied by the conference tone – with both interlocutors is over, replace the handset.

Call rerouting

The call rerouting feature lets you divert all external calls destined for your telephone to other receivers.

The system provides the option of assigning each receiver predetermined rerouting or follow-me rerouting.

For predetermined rerouting, you can decide whether to forward the call to an receiver (see programming manual, page 26) or to your own voicemail box (**optional card**).

Proceed as follows:



Lift the handset and wait for the dial tone.



Dial *** 7 0 2** to activate rerouting to a predetermined receiver.

Or



dial *** 7 0 4** to activate rerouting to your own voicemail box (optional card).

Or



dial *** 7 0 0** to disable previously set rerouting.

Or



dial *** 7 0 1** pre-enable the follow-me feature.



Wait for the 3 acknowledgement tones and replace the handset.

SPECIAL FUNCTIONS

Activating follow-me feature

Anyone pre-enabling the follow-me feature from his/her own set (see section entitled **Call rerouting** on page 24), can now activate the feature from the host receiver to receiver telephone calls destined for his/her own set there instead, until the destination is changed again.

To activate the feature, proceed as follows:



Lift the handset of the host set and wait for the dial tone.



Dial **(*) (7) (1)** + the number of your own receiver (50 ÷ 57) to activate the follow-me feature on the host set.



Wait for the 3 acknowledgement tones and replace the handset.

Repeat the procedure every time you change position.

Clock alarm/reminder

This function lets any user programme his/her receiver personally with the time the alarm is to go off (see programming manual for instructions on setting the system calendar, page 22).

Proceed as follows:



Lift the handset and wait for the dial tone.



Dial **(*) (6) (7)** followed by the hour (00÷24) and minutes (00÷59), always with 2 digits.



Wait for the 3 acknowledgement tones and replace the handset.

The telephone will ring up to 6 times at the programmed time with a ringing pattern of 3 rings lasting 0.2 s and a 4 s pause.

To disable this feature:



Lift the handset and wait for the dial tone.



Dial **(*) (6) (6)** to cancel the alarm call.



Wait for the 3 acknowledgement tones and replace the handset.

WARNING. *The alarm feature is valid for 24 hours.*

If there is a power failure, the alarm feature will not work.

SPECIAL FUNCTIONS

DAY/NIGHT mode

Receiver 50 is the only telephone enabled to select the DAY (default setting), NIGHT feature.

Proceed as follows:



Lift the handset of **receiver 50 only** and wait for the dial tone.



Dial ***900** to activate DAY mode.



Dial ***901** to activate NIGHT mode.



Wait for the 3 acknowledgement tones and replace the handset.

DISA FUNCTIONS

The DISA feature lets you call a specific receiver or send a fax directly from outside the system (see programming manual, page 33).

This feature can be implemented if the external call comes from a telephone with multifrequency dialling (if the telephone is set to decadic mode, pressing  switches it to multifrequency).

When an external call comes in, the switchboard answers automatically after 2 rings (programmable in the range 2 to 9, see programming manual, page 35), sending the caller the dial tone or, if optional card CTM/GV has been installed, a welcome message and voice prompts.

When the message ends, the switchboard waits a few seconds (programmable in the range 5 to 30, see programming manual, page 34) for the caller to dial a number in multifrequency:

- if the switchboard recognizes the number dialled as that of an receiver, the call is forwarded just to the chosen receiver for 50 s and, if there is no answer, to all receivers with ringing enabled for another 25 s.

- if the receiver does not recognize the number dialled as complete or correct, the call is forwarded to all enabled receivers for 25 s.

When the switchboard's automatic answering is enabled with DISA, the following features are available:

Activation of local telephone call rerouting to stored external number (DISA)

With switchboard CT2/8U (or CT1/6U with CTI/GSM card added), a local call can be rerouted onto the other telephone line and subsequently to a stored external number (speed dial number **48**, see programming manual, page 28).

To activate this feature, proceed as follows:



Lift the handset of **receiver 50 only** and wait for the dial tone.



Dial    .



Wait for the 3 acknowledgement tones and replace the handset.

To disable this feature:



Lift the handset of **receiver 50 only** and wait for the dial tone.



Dial    .



Wait for the 3 acknowledgement tones and replace the handset.

WARNING. *The DISA facility is temporarily unavailable while this feature is activated.*

DISA FUNCTIONS

Executing auxiliary command P1 via local line (DISA)

Executing command in pulse mode (monostable)



Lift your telephone's handset and call the switchboard.



Dial **8 1** +PASSWORD (see programming manual, page 24).



Wait for the 3 acknowledgement tones and replace the handset.

Executing command in ON/OFF mode (bistable)



Lift your telephone's handset and call the switchboard.



Dial **8 1** +PASSWORD to execute the command.



Dial **8 0** +PASSWORD to disable the command.



Wait for the 3 acknowledgement tones and replace the handset.

Executing auxiliary command P2 via local line (DISA)

Executing command in pulse mode (monostable)



Lift your telephone's handset and call the switchboard.



Dial **9 1** +PASSWORD (see programming manual, page 24).



Wait for the 3 acknowledgement tones and replace the handset.

Executing command in ON/OFF mode (bistable)



Lift your telephone's handset and call the switchboard.



Dial **9 1** +PASSWORD to execute the command.



Dial **9 0** +PASSWORD to disable the command.



Wait for the 3 acknowledgement tones and replace the handset.

DISA FUNCTIONS

Call pickup for call on given unattended receiver (DISA)

If a given telephone rings, announcing a call from another receiver or an incoming DISA call on the local line, and you want to answer with your own telephone, proceed as follows:



Lift your handset.



Dial ***** **4** **2** + the number of the receiver ringing (**5** **0**) ÷ **5** **7**).



Replace the handset when the conversation is over.

Password-protected unrestricted dialling on outside line (DISA)

This feature, only available with switchboard CT2/8U (or CT1/6U with CTI/GSM card added), lets you make a call from a remote phone, getting the second outside line through the actual switchboard.

Proceed as follows:



Lift the handset.



Dial **8** **2** + **PASSWORD** (see programming manual, page 25). Wait for the dial tone.



Dial the desired telephone number.



Replace the handset when the conversation is over.

When the called party or caller ends the conversation, if the telephone company can send this information, the system detects it and instantly frees the busy outside lines. If the end-of-conversation information is not sent, the backup timer intervenes, freeing the busy outside lines after a default time of 2 min (programmable in the range 1 to 9 min, see programming manual, page 31).

ACCESSORIES

The following optional cards can be employed to implement the switchboards' additional features:

CTI/200 - interface card for series-200 audio and video entry control installations for managing two calls, one door lock release command and up to four auxiliary commands;

CTI/300 - interface card for series-300 audio and video entry control installations for managing two calls, two door lock release commands and up to three auxiliary commands;

CTI/304 - video interface card for series-300 video entry control systems;

CTI/GSM - GSM card with antenna for use in managing a local telephone line (GSM);

CTM/... - music card (various melodies);

CTM/GV - music card with voice guide with 4 voice prompts and announcements;

TONES AND RINGING PATTERNS

Call ringing patterns

Type	Pulse	Pause
Local call	1	4
Call from receiver	0,6+0,2	4
Coded call	1+0,5x(1-8)	2
Call from entry panel	0,6+0,6	3,6
Callback	0,2+0,2+0,2	4

Warning tones

Type	Pulse	Pause	Frequency (Hz)
Dial tone (you can start dialling)	10	0	425+350
Call control (called user free)	1	4	425
Busy (called user engaged)	0,5	0,5	425
Dissuasion (codes dialled are not enabled)	0,1	0,1	425
Barge-in and programming (barge-in warning)	0,2+0,2	1,4	425
Hold (heard by interlocutor put on hold)	0,2+0,2	3,4	425
Call waiting (additional incoming call in NIGHT mode)	0,1	4,9	425
Acknowledgement (acceptance of requested programming)	0,1+0,1+0,1	1,5	425
Call on hold (call on hold during conversation in progress)	0,1	4,9	425
Conference (advises that conference call is in progress)	0,2	9,2	425
Coded general address call	1+0,5x(1-8)	2	425

NOTE. Times are given in seconds.

INDEX

Activation

- auxiliary command P1
via local line (DISA)28
- auxiliary command P2
via local line (DISA)28
- follow-me25
- hotline15
- local call rerouting to stored external
number (for CT2/8U only) (DISA)27

- Additional services** supplied by
the telephone company20

Alarm

- automatic message to stored
external stored18

Answering

- a local telephone call or
call from entry panel during
a conversation11
- for given unattended receiver29
- incoming calls9
- local telephone call or
call from entry panel for an
unattended receiver14

Barge-in

- on conversation in progress23

Call/Calls

- from local line or from entry
panel, pickup for unattended
receiver12
- from entry panel, rerouting
to local line16
- from entry panel, answering9
- general address21
- incoming calls, answering9
- local telephone call or call
from entry panel during
a conversation, answering11

- local, activating rerouting to stored
external number (for CT2/8U only) ...29
- on a given receiver, answering
when unattended31
- on hold, consultation hold10
- on local line9
- on specific local line21
- paging call with 8 call codes23
- rerouting24
- telephone call to other receivers9
- transfer11
- workgroup broadcast22

Callback

- outside line queuing or
busy receiver callback17

Command/Commands

- auxiliary 113
- auxiliary P1 and P219
- auxiliary P1 via local line,
executing28
- auxiliary P2 via local line,
executing28
- door lock release 113
- door lock release 220

Dialling

- Password-protected unrestricted
dialling on outside line
(for CT2/8U only)29

- DISA** functions27-29

Entry panel

- answering call9
- answering call during
a conversation11
- answering call for
unattended receiver12
- call rerouting to local line16
- door lock release command 113
- self-connection and switching14

INDEX

Follow-me

- activation25

Hold/park

- call hold and retrieval10
- local telephone call park
to change receiver17

Hotline

- activation15

Mode

- DAY/NIGHT mode26

- Privacy** (do-not-disturb feature)18

Redial

- last local number redial9

Rerouting

- calls24
- calls from entry panel to local line16

Scanning

- entry panels, self-connection14

Self-connection

- and switching between entry panels ..14

Speed dialling

- dedicated15
- general15

Switching

- interlocutor switching10

- Temporary override** of direct
distance dialling restriction22

Three way conferencing

- (2 internal and 1 external line)24



BPT S.p.A.
30020 Cinto Caomaggiore
Venezia - Italy