

Ex-control stations - enclosures moulded plastic GHG 41 / 43



Type 411 81



Type 411 82



Type 432



Type 434

4 Technical data

Ex-control stations Type 41. and 43. for individual configuration

Marking accd. to 2014/34/EU	⊕ II 2 G Ex ed ib m IIC T6 ¹⁾ ⊕ II 2 D Ex tD A21 IP66 T80 °C
EC-Type Examination Certificate	PTB 00 ATEX 3117 ¹⁾
IECEX Certificate of Conformity	IECEX BK1 04.0003 ¹⁾
Marking accd. to IECEx	Ex e II T6, Ex e ib IIC T6, Ex ed IIC T6 or Ex ed ib IIC T6 ¹⁾
Permissible ambient temperature	-20 °C up to +40 °C ¹⁾ -55 °C up to +55 °C (option)
Rated voltage	690 V AC
Rated current	16 A
Connecting terminals	2 x 4 mm ²
Protection class	I
Degree of protection accd. to EN 60529	IP66 (standard)
Enclosure material	Polyamide
Enclosure colour	black

Type 411 81

Cable glands/Gland plates/Enclosure drilling	Ex e cable glands max. 2 x M25; 2 x M20 thread
Dimensions (L x W x H)	85 x 85 x 77.5 mm
Weight (empty)	0.25 kg
Components arrangement	1 mounting area

Type 411 82

Cable glands/Gland plates/Enclosure drilling	Ex e cable glands max. 2 x M25; 2 x M20 thread
Dimensions (L x W x H)	125 x 85 x 77.5 mm
Weight (empty)	0.35 kg
Components arrangement	2 mounting areas

Type 411 83

Cable glands/Gland plates/Enclosure drilling	Ex e cable glands max. 2 x M25; 2 x M20 thread
Dimensions (L x W x H)	165 x 85 x 77.5 mm
Weight (empty)	0.45 kg
Components arrangement	3 mounting areas

Type 432

Cable glands/Gland plates/Enclosure drilling	Ex e cable glands max. 2 x M25; 3 x M20 thread
Dimensions (L x W x H)	156 x 100 x 90 mm
Weight (empty)	0.47 kg
Components arrangement	2 mounting areas

Type 434

Cable glands/Gland plates/Enclosure drilling	Ex e cable glands max. 2 x M25; 3 x M20 thread
Dimensions (L x W x H)	245 x 100 x 90 mm
Weight (empty)	0.70 kg
Components arrangement	4 mounting areas

¹⁾Data for ready configured product



Type 434



Type 432



Type 411 82



Type 411 81

Ordering codes (Code 1)

1. Enclosure	2. Components arrangement/terminals				3. Labels/ padlocking facility	4. Cable glands
	Mounting area 1	Mounting area 2	Mounting area 3	Mounting area 4		
411 81 ¹⁾	X	-	-	-	X	X
411 82	X	X	-	-	X	X
411 83	X	X	X	-	X	X
432	X	X	-	-	X	X
434	X	X	X	X	X	X

Possible components (Code 1)

Component	Code	Component	Code
Pushbutton (2-pole or 4-pole ²⁾)	DRT	Measuring instrument	AM72 ²⁾
Double pushbutton (2-pole or 4-pole ²⁾)	DDT	Measuring instrument	AM45
Key-operated pushbutton (2-pole or 4-pole ²⁾)	SLT	Signal lamp	SIL
Key-operated switch (2-pole or 4-pole ²⁾)	SLS	Potentiometer	POT
Control switch (2-pole or 4-pole ²⁾)	SCT	Terminal block (4 mm ²)	KLM
Mushroom-head pushbutton (2-pole or 4-pole ²⁾)	SGT	Blanking element	BLV
Control switch	GHG 23 ³⁾		

¹⁾ 4-pole component not possible

²⁾ 2 mounting areas are needed

³⁾ only for type 43., 2 mounting areas are needed

Ex-control stations - enclosures GHG 41 / 43



Type 411 81



Type 411 82



Type 432



Type 434

4 Mounting areas | Dimension drawing

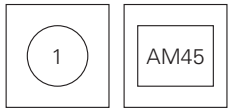

Type 411 81

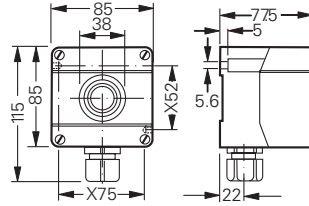

Type 411 82

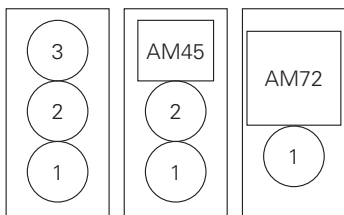
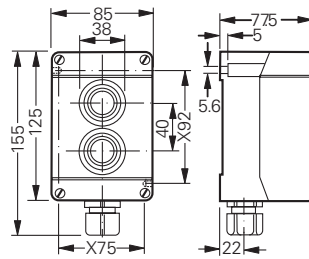

Type 411 83

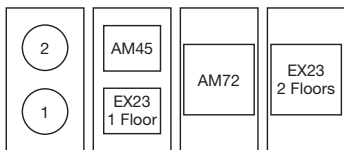
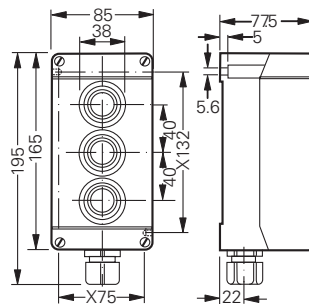

Type 432

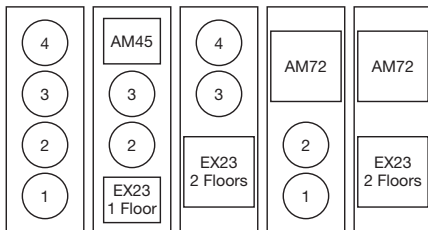
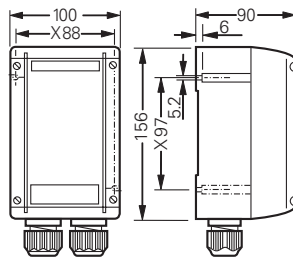

Type 434

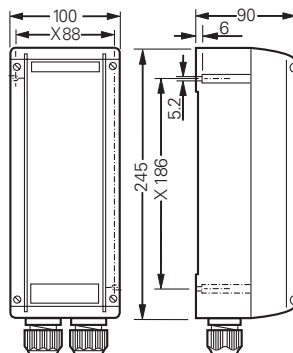

X = fixing dimension

Dimensions in mm



Type 414 82



Type 414 81



Type 413 85



Type 413 84

Technical data

Ex-control stations type 413. and 414. for individual configuration

Marking accd. to 2014/34/EU	⊕ II 2 G Ex ed ib m IIC T6 ¹⁾ ⊕ II 2 D Ex tD A21 IP66 T80 °C
EC-Type Examination Certificate	PTB 00 ATEX 3117 ¹⁾
IECEX Certificate of Conformity	IECEX BK1 04.0003 ¹⁾
Marking accd. to IECEx	Ex e II T6, Ex e ib IIC T6, Ex ed IIC T6 or Ex ed ib IIC T6 ¹⁾
Permissible ambient temperature	-20 °C up to +40 °C ¹⁾ -55 °C up to +55 °C (option)
Rated voltage	690 V AC
Rated current	16 A
Connecting terminals	see technical data for built-in components
PE-connecting terminals	2 x 4 mm ²
Protection class	I
Degree of protection accd. to EN 60529	IP66 (standard)

	Type 413 84	Type 413 85
Cable glands/Gland plates/Enclosure drilling	max. 2 x M25; 2 x M20	max. 2 x M25; 2 x M20
Dimensions (L x W x H)	122 x 120 x 81 mm	122 x 120 x 81 mm
Weight (empty)	0.85 kg	1.45 kg
Enclosure material	cast aluminium-silicon (AlSi)	cast aluminium-silicon (AlSi)
Enclosure colour	grey RAL 7031	grey RAL 7031
Components arrangement	2 mounting areas	4 mounting areas

	Type 414 81	Type 414 82
Cable glands/Gland plates/Enclosure drilling	max. 3 x Ø 21 for cable gland M20 max. 2 x Ø 25.5 for cable gland M25	max. 4 x Ø 21 for cable gland M20 max. 2 x Ø 25.5 for cable gland M25
Dimensions (L x W x H)	166 x 140 x 76 mm	286 x 140 x 76 mm
Weight (empty)	1.40 kg	2.10 kg
Enclosure material	stainless steel AISI 316 L	stainless steel AISI 316 L
Enclosure colour	polished	polished
Components arrangement	2 mounting areas	4 mounting areas

¹⁾Data for ready configured product

Ex-control stations - enclosures GHG 413 / 414



Type 413 84



Type 413 85



Type 414 81



Type 414 82

4 Ordering codes (Code 1)

1. Enclosure	2. Components arrangement/terminals				3. Labels/ padlocking facility	4. Cable glands
	Mounting area 1	Mounting area 2	Mounting area 3	Mounting area 4		
413 84	X	X	–	–	X	X
413 85	X	X	X	X	X	X
414 81	X	X	–	–	X	X
414 82	X	X	X	X	X	X

Possible components (Code 1)

Component	Code	Component	Code
Pushbutton (2-pole or 4-pole ¹⁾)	DRT	Measuring instrument	AM72 ¹⁾
Double pushbutton (2-pole or 4-pole ¹⁾)	DDT	Measuring instrument	AM45
Key-operated pushbutton (2-pole or 4-pole ¹⁾)	SLT	Signal lamp	SIL
Key-operated switch (2-pole or 4-pole ¹⁾)	SLS	Potentiometer	POT
Control switch (2-pole or 4-pole ¹⁾)	SCT	Terminal block (4 mm ²)	KLM
Mushroom-head pushbutton (2-pole or 4-pole ¹⁾)	SGT	Blanking element	BLV
Control switch	GHG 23 ¹⁾		

¹⁾ 2 mounting areas are needed



Type 414 82



Type 414 81



Type 413 85



Type 413 84

Mounting areas I Dimension drawing

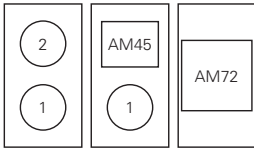

Type 413 84

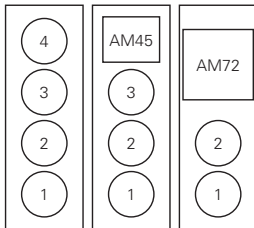
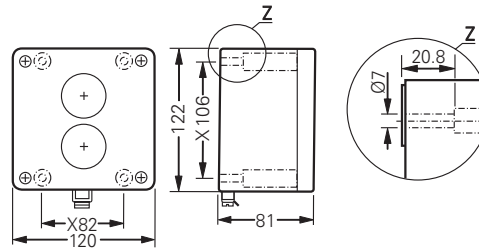

Type 413 85

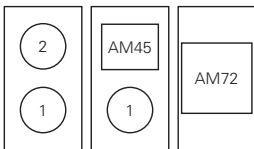
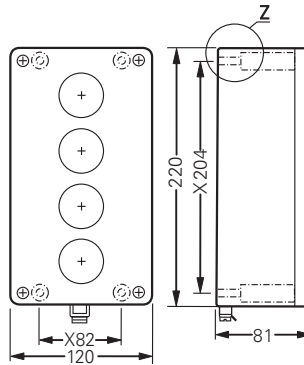

Type 414 81

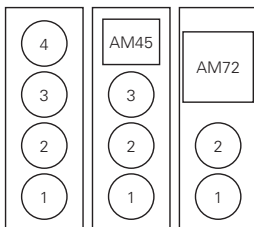
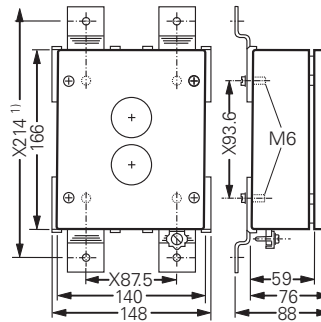

Type 414 82

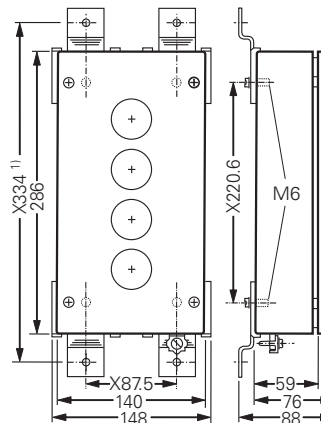

X = fixing dimension

Dimensions in mm

Ex-control stations - enclosures GHG 44



Type 444 23



Type 448 23



Type 449 23



Type 447 23

4 Technical data

Ex-control stations Typ 444, 448, 449, and 447 for individual configuration

Marking accd. to 2014/34/EU	⊕ II 2 G Ex de ia/ib m [ia/ib] IIC T6 ¹⁾ ⊕ II 2 D Ex tD A21 IP66/IP65 T80 °C
EC-Type Examination Certificate	PTB 99 ATEX 1044 ¹⁾
IECEX Certificate of Conformity	IECEX BK1 07.0023 ¹⁾
Marking accd. to IECEx	Ex de ia/ib m [ia/ib] IIC T4 .. T6 ¹⁾ Ex tD A21 IP66 T80 °C
Permissible ambient temperature	-20 °C up to +40 °C ¹⁾ -55 °C up to +55 °C (option)
Rated voltage	690 V AC
Rated current	40 A
Connecting terminals	see technical data for built-in components
PE-Connecting terminals	2 x 4 mm ²
Protection class	I
Degree of protection accd. to EN 60529	IP66 (standard)
Cable glands/Gland plates/Enclosure drilling	as ordered accd. to manufacturer's specification
Enclosure material	glass-fibre reinforced polyester
Enclosure colour	black

Type 444 23

Connecting terminals	max. 20 terminals UT 4
Dimensions (L x W x H)	271 x 134 x 136 mm
Weight (empty)	1.5 kg with mounting framework
Components arrangement	6 mounting areas

Type 448 23

Connecting terminals	max. 30 terminals UT 4
Dimensions (L x W x H)	271 x 271 x 136 mm
Weight (empty)	2.5 kg with mounting framework
Components arrangement	distance 40 mm max. 18 mounting areas distance 50 mm max. 15 mounting areas distance 60 mm max. 12 mounting areas

Type 449 23

Connecting terminals	max. 60 terminals UT 4
Dimensions (L x W x H)	544 x 271 x 136 mm
Weight (empty)	4.5 kg with mounting framework
Components arrangement	distance 40 mm max. 36 mounting areas distance 50 mm max. 30 mounting areas distance 60 mm max. 24 mounting areas

Type 447 23

Connecting terminals	max. 90 terminals UT 4
Dimensions (L x W x H)	817 x 271 x 136 mm
Weight (empty)	6.5 kg with mounting framework
Components arrangement	distance 40 mm max. 64 mounting areas distance 50 mm max. 45 mounting areas distance 60 mm max. 36 mounting areas

¹⁾ Data for ready configured product



Type 447 23



Type 449 23



Type 448 23



Type 444 23

Ordering codes (Code 1)

1. Enclosure	2. Components arrangement/terminals				3. Labels/ padlocking facility	4. Cable glands
	Mounting 1 ... 6	Mounting 7 ... 18	Mounting 19 ... 27	Mounting 37 ... 64		
444 23	X	-	-	-	X	X
448 23	X	X	-	-	X	X
449 23	X	X	X	-	X	X
447 23	X	X	X	X	X	X

Possible components (Code 1)

Component	Code	Component	Code
Pushbutton (2-pole or 4-pole ²⁾)	DRT	Measuring instrument	AM72 ¹⁾
Double pushbutton (2-pole or 4-pole ²⁾)	DDT	Measuring instrument	AM45
Key-operated pushbutton (2-pole or 4-pole ²⁾)	SLT	Signal lamp	SIL
Key-operated switch (2-pole or 4-pole ²⁾)	SLS	Potentiometer	POT
Control switch (2-pole or 4-pole ²⁾)	SCT	Terminal block (4 mm ²)	KLM ... A ²⁾
Mushroom-head pushbutton (2-pole or 4-pole ²⁾)	SGT	Terminal block (4 mm ²)	KLM ... B
Control switch	GHG 23 ¹⁾	Blanking element	BLV

¹⁾ 2 mounting areas are needed

²⁾ Serial terminals and PE-Terminal are mounted on a rail below the hinged frame

Ex-control stations - enclosures GHG 44



Type 444 23



Type 448 23



Type 449 23



Type 447 23

4 Mounting areas I Dimension drawing

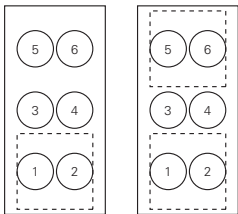
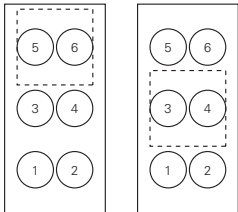

Distance between centres 40, 50 and 60 mm for positioning of built-in components

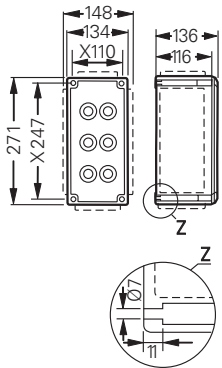

Type 444 23

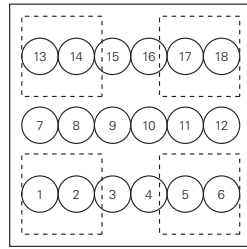

Distance between centres 40 mm

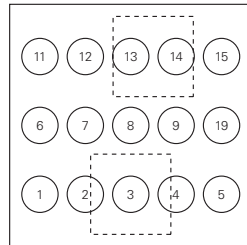

Distance between centres 50 mm

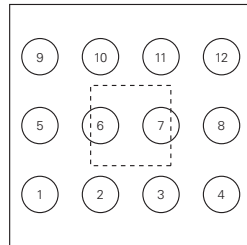

Distance between centres 60 mm

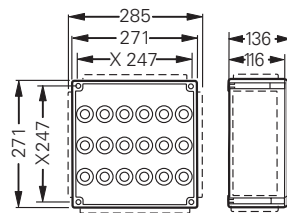

Type 448 23

X = fixing dimension

○ = mounting space for switch, pushbutton (2-pole) or signal lamp

□ = mounting space for switch, pushbutton (4-pole) ampere- or voltmeter



Type 447 23



Type 449 23



Type 448 23



Type 444 23

Mounting areas I Dimension drawing

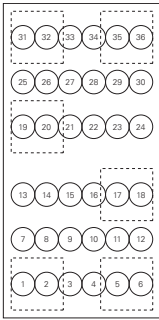

Distance between centres 40 mm

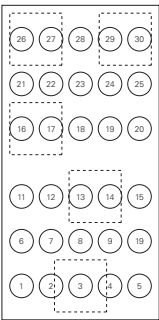

Distance between centres 50 mm

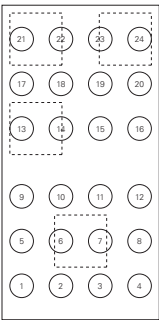

Distance between centres 60 mm

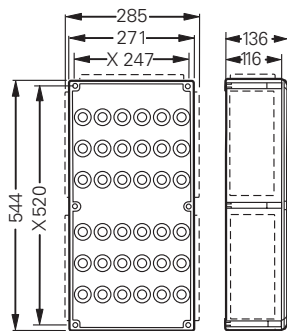

Type 449 23

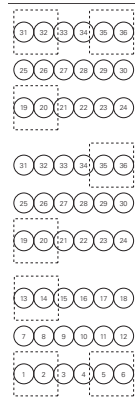

Distance between centres 40 mm

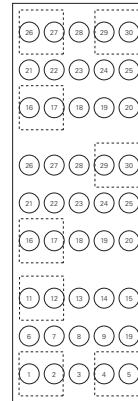

Distance between centres 50 mm

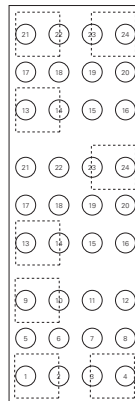

Distance between centres 60 mm

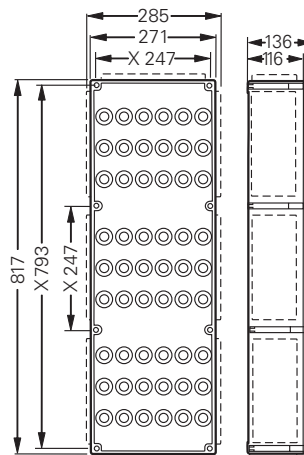

Type 447 23

X = fixing dimension

Ex-control stations - enclosures GHG 443



Type 443 34

4 Technical data

Ex-control stations Typ 443 34 for individual configuration

Marking accd. to 2014/34/EU	Ⓜ II 2 G Ex ed ia/ib m IIC T6 ¹⁾ Ⓜ II 2 D Ex tD A21 IP66 T80 °C
EC-Type Examination Certificate	PTB 01 ATEX 1115 ¹⁾
Permissible ambient temperature	-20 °C up to +40 °C ¹⁾ -55 °C up to +55 °C (option)
Rated voltage	690 V AC
Rated current	63 A
Connecting terminals	as ordered accd. to manufacturer's specification
PE-Connecting terminals	2 x 4 mm ²
Protection class	I
Degree of protection accd. to EN 60529	IP66
Cable glands/Gland plates/Enclosure drilling	as ordered accd. to manufacturer's specification
Dimensions (L x W x H)	280 x 180 x 90 mm
Weight	2.3 kg with mounting framework
Enclosure material	cast aluminium-silicon (AlSi)
Enclosure colour	grey RAL 7031
Components arrangement	max. 9 mounting areas

¹⁾Data for ready configured product

Ordering codes (Code 1)

1. Enclosure	2. Components arrangement/terminals			3. Labels/ padlocking facility	4. Cable glands
	Mounting 1 ... 3	Mounting 4 ... 6	Mounting 7 ... 9		
443 34	X	X	X	X	X

Possible components (Code 1)

Component	Code	Component	Code
Pushbutton (2-pole or 4-pole ²⁾)	DRT	Measuring instrument	AM72 ¹⁾
Double pushbutton (2-pole or 4-pole ²⁾)	DDT	Measuring instrument	AM45
Key-operated pushbutton (2-pole or 4-pole ²⁾)	SLT	Signal lamp	SIL
Key-operated switch (2-pole or 4-pole ²⁾)	SLS	Potentiometer	POT
Control switch (2-pole or 4-pole ²⁾)	SCT	Terminal block (4 mm ²)	KLM ... A ²⁾
Mushroom-head pushbutton (2-pole or 4-pole ²⁾)	SGT	Terminal block (4 mm ²)	KLM ... B
Control switch	GHG 23 ¹⁾	Blanking element	BLV

¹⁾ 2 mounting areas are needed

²⁾ Serial terminals and PE-Terminal are mounted on a rail below the hinged frame



Type 443 34

Mounting areas | Dimension drawing

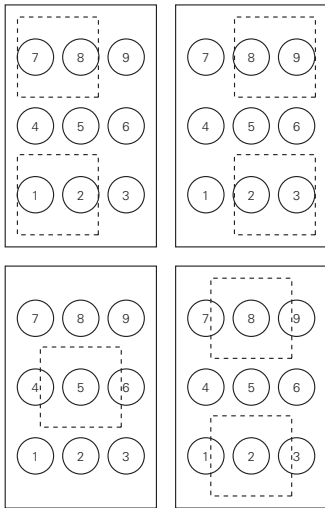

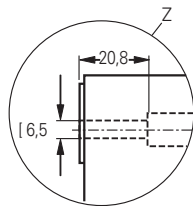
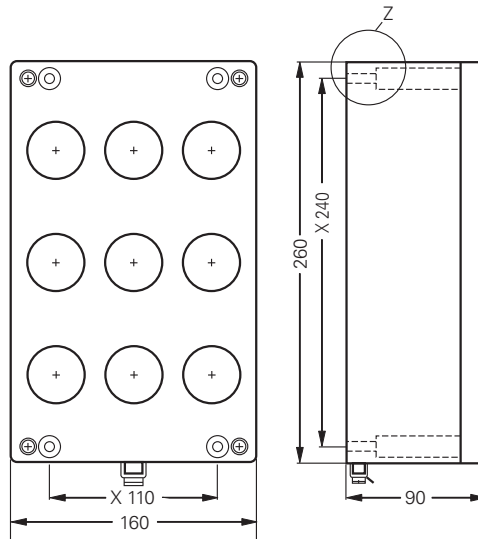

Distance between centres 40, 50 and 60 mm for positioning of built-in components



Type 443 34

X = fixing dimension

 = mounting space for switch, pushbutton (2-pole) or signal lamp

 = mounting space for switch, pushbutton (4-pole) ampere- or voltmeter

Ex-control stations - enclosures GHG 44. 33



Type 444 33



Type 448 33



Type 449 33



Type 447 33

4 Technical data

Ex-control stations Typ 444, 448, 449, and 447 stainless steel for individual configuration

Marking accd. to 2014/34/EU	⊕ II 2 G Ex de ia/ib m [ia/ib] IIC T6 ¹⁾ ⊕ II 2 D Ex tD A21 IP66/IP65 T80 °C
EC-Type Examination Certificate	PTB 99 ATEX 1044 ¹⁾
IECEX Certificate of Conformity	IECEX BK1 07.0023 ¹⁾
Marking accd. to IECEx	Ex de ia/ib m [ia/ib] IIC T4 .. T6 ¹⁾ Ex tD A21 IP66 T80 °C
Permissible ambient temperature	-20 °C up to +40 °C ¹⁾ -55 °C up to +55 °C (option)
Rated voltage	690 V AC
Rated current	40 A
Connecting terminals	see technical data for built-in components
PE-Connecting terminals	2 x 4 mm ²
Protection class	I
Degree of protection accd. to EN 60529	IP66 (standard)
Cable glands/Gland plates/Enclosure drilling	as ordered accd. to manufacturer's specification
Enclosure material	Stainless steel AISI 316 L
Enclosure colour	polished

Type 444 33

Connecting terminals	max. 20 terminals UT 4
Dimensions (L x W x H)	312.5 x 175 x 135 mm
Weight (empty)	3.5 kg with mounting framework
Components arrangement	6 mounting areas

Type 448 33

Connecting terminals	max. 30 terminals UT 4
Dimensions (L x W x H)	312.5 x 312.5 x 135 mm
Weight (empty)	7.5 kg with mounting framework
Components arrangement	distance 40 mm max. 18 mounting areas distance 50 mm max. 15 mounting areas distance 60 mm max. 12 mounting areas

Type 449 33

Connecting terminals	max. 60 terminals UT 4
Dimensions (L x W x H)	627 x 312.5 x 135 mm
Weight (empty)	11.5 kg with mounting framework
Components arrangement	distance 40 mm max. 36 mounting areas distance 50 mm max. 30 mounting areas distance 60 mm max. 24 mounting areas

Type 447 33

Connecting terminals	max. 90 terminals UT 4
Dimensions (L x W x H)	941.5 x 312.5 x 135 mm
Weight (empty)	16.5 kg with mounting framework
Components arrangement	distance 40 mm max. 54 mounting areas distance 50 mm max. 45 mounting areas distance 60 mm max. 36 mounting areas

¹⁾Data for ready configured product



Type 447 33



Type 449 33



Type 448 33



Type 444 33

Ordering codes (Code 1)

1. Enclosure	2. Components arrangement/terminals				3. Labels/ padlocking facility	4. Cable glands
	Mounting 1 ... 6	Mounting 7 ... 18	Mounting 19 ... 27	Mounting 37 ... 64		
444 33	X	–	–	–	X	X
448 33	X	X	–	–	X	X
449 33	X	X	X	–	X	X
447 33	X	X	X	X	X	X

Possible components (Code 1)

Component	Code	Component	Code
Pushbutton (2-pole or 4-pole ²⁾)	DRT	Measuring instrument	AM72 ¹⁾
Double pushbutton (2-pole or 4-pole ²⁾)	DDT	Measuring instrument	AM45
Key-operated pushbutton (2-pole or 4-pole ²⁾)	SLT	Signal lamp	SIL
Key-operated switch (2-pole or 4-pole ²⁾)	SLS	Potentiometer	POT
Control switch (2-pole or 4-pole ²⁾)	SCT	Terminal block (4 mm ²)	KLM ... A ²⁾
Mushroom-head pushbutton (2-pole or 4-pole ²⁾)	SGT	Terminal block (4 mm ²)	KLM ... B
Control switch	GHG 23 ¹⁾	Blanking element	BLV

¹⁾ 2 mounting areas are needed

²⁾ Serial terminals and PE-Terminal are mounted on a rail below the hinged frame

Ex-control stations - enclosures GHG 44. 33



Type 444 33



Type 448 33



Type 449 33



Type 447 33

4 Mounting area I Dimension drawing

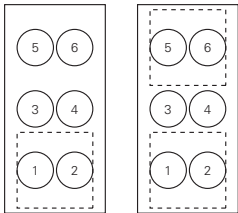
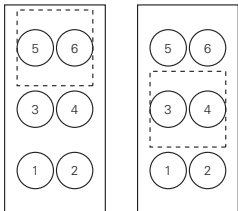

Distance between centres 40, 50 and 60 mm

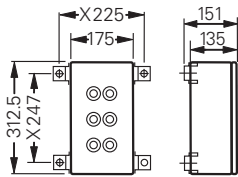

Type 444 33

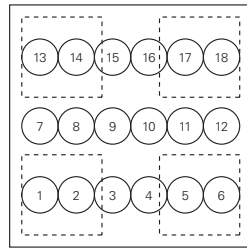

Distance between centres 40 mm

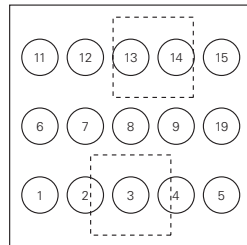

Distance between centres 50 mm

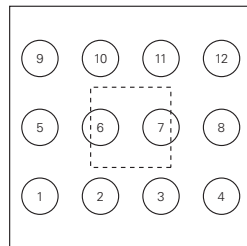

Distance between centres 60 mm

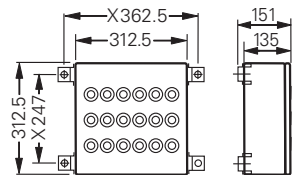

Type 448 33

X = fixing dimension

○ = mounting space for switch, pushbutton (2-pole) or signal lamp

┌ ─ ─ ─ ┐
| | = mounting space for switch, pushbutton (4-pole) ampere- or voltmeter
└ ─ ─ ─ ┘

Dimensions in mm



Type 447 33



Type 449 33



Type 448 33



Type 444 33

Mounting area | Dimension drawing

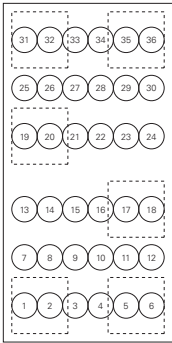

Distance between centres 40 mm

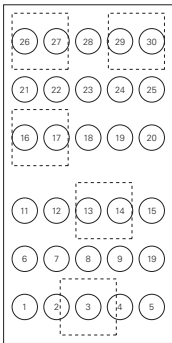

Distance between centres 50 mm

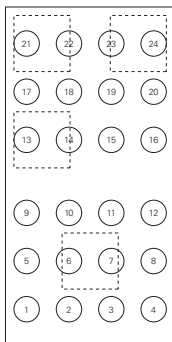

Distance between centres 60 mm

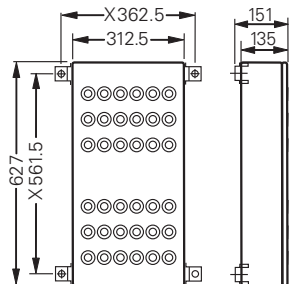

Type 449 33

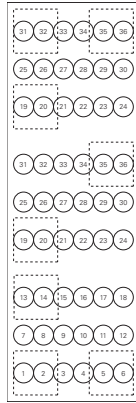

Distance between centres 40 mm

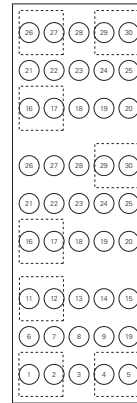

Distance between centres 50 mm

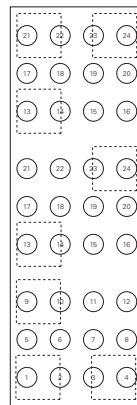

Distance between centres 60 mm

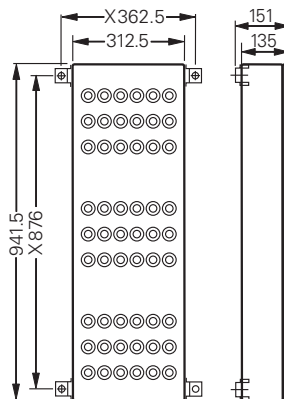

Type 447 33

X = fixing dimension