

KERN-EX1/21-J-L04-840-1900-NM3A-08-PD

Product type: **V0011J04019-84NMDOPD050008S**

Item number: **63586**

IP66/IP67

1/21



The KERN is a compact industrial and emergency luminaire designed for ATEX Zone 1/21 hazardous areas. The body is made of robust polycarbonate (RAL 7035) and is UV stable, ensuring long-term durability. The housing is made of opal polycarbonate, which provides effective light diffusion and high impact resistance. The luminaire is available in different chromaticity temperatures to adapt to different environments. The luminaire can be equipped with a dimming function on request. Designed to be mounted and suspended.

ADVANTAGES:

- European product – made in the Czech Republic
- ATEX/IECEX certification – zone 1/21
- Compact size
- Robust IK08 body
- High water and dust resistance IP66/IP67
- UV resistance
- High specific output up to 116 lm/W
- Wide temperature resistance from -30 °C to +50 °C (depending on luminaire variant)
- Control with certified DALI2 driver

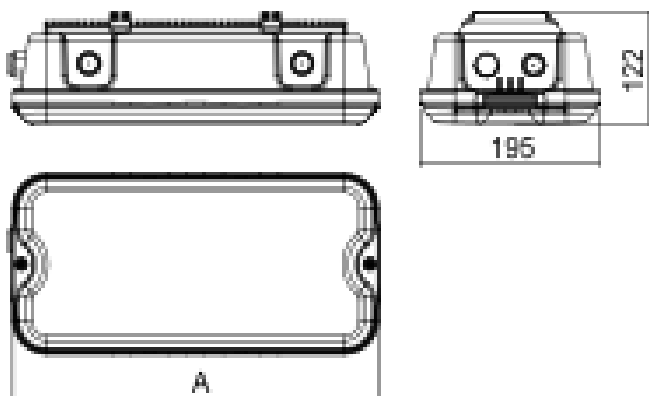

Dimensions

A x B x C 395 mm x 195 mm x 122 mm

Net weight 3,82 kg

Specifications

Light technical data

Lighting fixture luminous flux	1742 lm +/-10%	Luminaire luminous flux in emergency mode	441 lm +/-10%
Luminaire efficiency	116 lm/W	CRI	≥80
MacAdam	3	Lifetime L80B50@max°C	63 000 h
Lifetime L90B50@25°C	110 000 h	Beam angle	Very wide beam >80°
Colour temperature	4000 K		

Electrical data

Power input	15 W	Luminaire power in emergency mode	3,5 W
Rated voltage AC	220-240 V	Frequency	50/60 Hz
Rated voltage DC	220-240 V	Control method	ON/OFF luminaire + emergency 3h, AUTOTEST
Through-wiring	Without through-wiring	Insulation class	I
Battery type	NiCd	Luminaire autonomy (min)	180

Mechanical data

IP classification	IP66/IP67	IK classification	IK08
Warranty	5 years	Operating temperature	0°Csta≤35°C

Certification

ATEX	FTZU 25 ATEX 0017X	IECEX	IECEX FTZÚ 25.0012X
------	--------------------	-------	---------------------

Explosion protection ATEX

Ex ZONE	1/21	ATEX zone – gas	Ex II 2G Ex eb mb IIC T4 Gb
ATEX zone – dust	Ex II 2D Ex tb IIIC T85°C Db		

Explosion protection IECEX

IECEX zone – dust	Ex tb IIIC T85°C Db	IECEX zone – gas	Ex eb mb IIC T4 Gb
-------------------	---------------------	------------------	--------------------

Materials

Material of the body	PC (polycarbonate)	Body colour	RAL 7035 grey
Cover material	PC (polycarbonate) opal		

Packaging

Barcode (EAN)	8592040460330	Number of pieces per pallet	56 pcs
Gross weight	4,16 kg		

Accessories to order
Cable suspender – 3 m (2 pcs)

Item number: **3575**
 Product type: **051131**

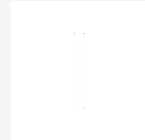
Wall bracket

Item number: **6902**
 Product type: **061066**

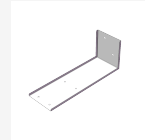
KERN protective cage – L04

Item number: **62858**
 Product type: **001610-RAL9016**

Set of wall brackets – angle 45° KERN, AISI304 (2 pcs)

Item number: **63139**
 Product type: **051159**

Set of pole brackets (Ø 60 mm), AISI304 (2 pcs)

Item number: **60089**
 Product type: **051093**

Set of pole brackets (Ø 50 mm), AISI304 (2 pcs)

Item number: **60090**
 Product type: **051094**

Set of pole brackets (Ø 42 mm), AISI304 (2 pcs)

Item number: **60091**
 Product type: **051095**

KERN accessories– glands for armored cable

Item number: **63458**
 Product type: **051162**

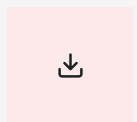
Set of pole brackets (Ø 60 mm), AISI316 (2 pcs)

Item number: **66929**
 Product type: **051125**



Set of pole brackets (Ø 50 mm), AISI316 (2 pcs)

Item number: **66930**

Product type: **051126**



Set of pole brackets (Ø 42 mm), AISI316 (2 pcs)

Item number: **66931**

Product type: **051127**



KERN – Grounding washer under cable glands (1 pc)

Item number: **66889**

Product type: **051163**



Set of wall brackets – angle 45° KERN, AISI316 (2 pcs)

Item number: **66937**

Product type: **051164**



Pictogram KERN – with escape route to the left

Item number: **62832**

Product type: **009466**



Pictogram KERN – with escape route to the right

Item number: **62833**

Product type: **009467**



Pictogram KERN – with escape route downstairs

Item number: **62834**

Product type: **009468**



Pictogram KERN – with escape route upstairs

Item number: **62835**

Product type: **009469**



Pictogram KERN – with EXIT

Item number: **62836**

Product type: **009470**



Tightening wrench for cable glands

Item number: **63024**
 Product type: **038014**



Set of fastening bracket KERN – IK10 (AISI304) – (2 pcs)

Item number: **66947**
 Product type: **051165**

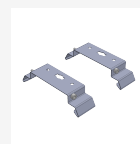

Set of fastening bracket KERN – IK10 (AISI316L) – (2 pcs)

Item number: **66948**
 Product type: **051166**

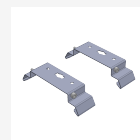

Polar diagram

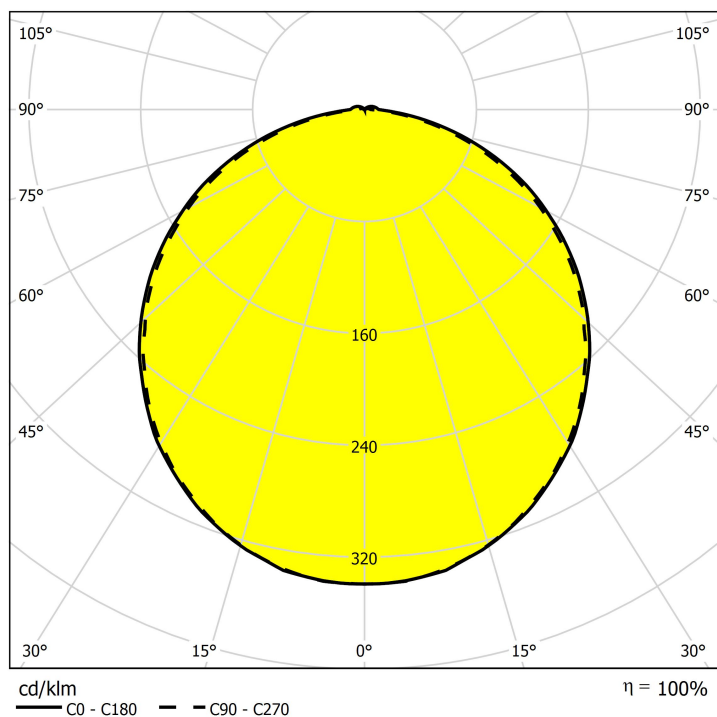

© 2026 All rights reserved. VYRTYCH a.s. does not warrant the accuracy or completeness of the information provided herein and is not responsible for any events that may occur as a result of unqualified reliance on this information. The information contained herein does not constitute a commercial offer and does not form part of a quotation or contract, unless confirmed by VYRTYCH a.s..