

TM-CB A

S0506 S0510 S0706 S0710

S0506P S0510P S0706P S0710P

CENTRAL BATTERY SYSTEM

Operation and Maintenance Documentation 1.01.001/01.06.2020/IP30



Table of Contents

- 1. Introduction 3
- 2. Meaning of the Name 4
- 3. Description of the Device 5
 - 3.1. List of Components 6
 - 3.2. System Specification 8
 - 3.3. Substation Specification 9
 - 3.4. System Versions..... 9
 - 3.5. Current Loop 10
 - 3.6. Total Stop..... 10
 - 3.7. Description of outputs..... 11
 - 3.8. Fuse table..... 12
- 4. Safety Instructions 13
- 5. Instructions for Installation and Commissioning..... 13
 - 5.1. Unpacking and Arrangement 13
 - 5.2. Mounting of the Cabinet..... 13
 - 5.3. Installation of Accumulators 16
 - 5.4. Connection of Receivers 18
 - 5.5. Connection of Devices 19
 - 5.6. Connection of Substation..... 20
 - 5.7. Installation of Fuses..... 20
 - 5.8. Setting the Station Address 20
 - 5.9. Connection of AC Voltage..... 20
 - 5.10. Ethernet connection..... 21
 - 5.11. Connection of the internal phase monitor 21
 - 5.12. Starting the System 21
 - 5.13. Turning the System Off (RESET)..... 23
 - 5.14. Mounting USB end caps..... 23
- 6. Storage Conditions 24
- 7. Functions of Individual Modules of the System 24
 - 7.1. Charger 24
 - 7.2. Accumulators..... 25
 - 7.3. Coordinator..... 26
 - 7.4. Circuit Controller 27
 - 7.5. TM-I/O 30
 - 7.6. Dedicated Addressable Modules TM-AM 02H, TM-AM 02V, TM-AM 03 31
 - 7.7. Universal Addressable Module TM-AM 01 31
 - 7.8. C-PANEL CB Computer 31
- 8. Example of TM-CB A Central Battery System Installation 33
- 9. Maintenance and Service 34
- 10. Troubleshooting and Help..... 35

List of Appendices

- C-PANEL CB – Instruction Manual
- MW Power MWP 5-12L Accumulator Specification
- MW Power MW 7,2-12L Accumulator Specification
- Configuration manual of addressable modules for **TM-CB** systems
- Manual of addressable module **TM-AM 01**
- TM-I/O – Instruction Manual

1. Introduction

Emergency lighting is a set of fire protection devices allowing for safe evacuation of people who are in the building at the time of an emergency.

Legal requirements for auto-switching backup power, and guidelines on the scope of application of emergency lighting oblige the owner or user of the building to check the status of these devices and ensure that they are in proper condition. Correct operation and maintenance require a lot of time and are often difficult and thus, can lead to omissions or negligence with tragic consequences.

TM Technologie developed Central Battery System TM-CB A, allowing the supervision of circuits and fittings within the system. The control unit monitors the correct operation of emergency lighting devices installed in the building. It determines their status through automatic function and autonomy tests and by checking the correctness of parameters. With this solution, information on all circuits and fittings installed in the building and connected to the system are readily and promptly available to the user at one location.

2. Meaning of the Name

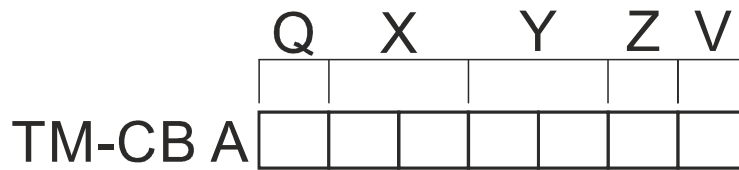

TM-CB	A	Q	X Accumulator capacity [Ah]	Y Number of circuits	Z Housing	V Control panel C-PANEL CB
Product family	230 AC / 216 DC	S - housing type S0 "Slim"	05 07	6 10	(blank field) – closed housing	P – control panel installed (blank field) – no control panel

Model	Maximum power*			Number of circuits	Number of fittings	Panel	Closed housing
	1h	2h	3h				
S0506	650 W	470 W	270 W	6	200	-	S0
S0506P	650 W	470 W	270 W	6	200	+	S0
S0510	650 W	470 W	270 W	10	200	-	S0
S0510P	650 W	470 W	270 W	10	200	+	S0
S0706	900 W	650 W	400 W	6	200	-	S0
S0706P	900 W	650 W	400 W	6	200	+	S0
S0710	900 W	650 W	400 W	10	200	-	S0
S0710P	900 W	650 W	400 W	10	200	+	S0

*Warning! Power calculated for Ta = 20 °C - For extreme operating temperatures, the power is adjusted according to the battery characteristics (for example, Ta = 0 °C it should be reduced to 80%).

3. Description of the Device

The central battery system **TM-CB A** allows the connection of fluorescent, halogen and LED fittings, depending on the type of modules used. Each main control cabinet can be connected to substations. Thanks to the substation, the system can be extended by another 10 circuits. **TM-CB A** supports up to 63 substations. The maximum number of circuits is 640, which allows to connect and monitor up to 12 800 fittings.

Compatible components of the system:

- Control unit: C-PANEL TM-CB A,
- Substations: TM-CB A - each substation consists of:
 - ✓ housing with accessories (accumulators, transformer, fuses),
 - ✓ coordinator,
 - ✓ charger,
 - ✓ circuit controllers,
 - ✓ LED PANEL,
 - ✓ current measurement unit.

Optionally, the device can be connected to:

- fittings for DC power supply,
- universal addressable modules TM-AM 01, TM-AM 01S,
- dedicated addressable modules TM-AM 02H, TM-AM 02V, TM-AM 03,
- TM-I/O (models IN SW, IN 24, IN 230 and OUT) modules,

NOTE! The IN / OUT model used exclusively for the DATA 2 emergency lighting monitoring system cannot be connected.

- external phase monitor.

The substation must be provided with primary power supply and communication cable RS485.

3.1. List of Components

a) Version 6 circuits

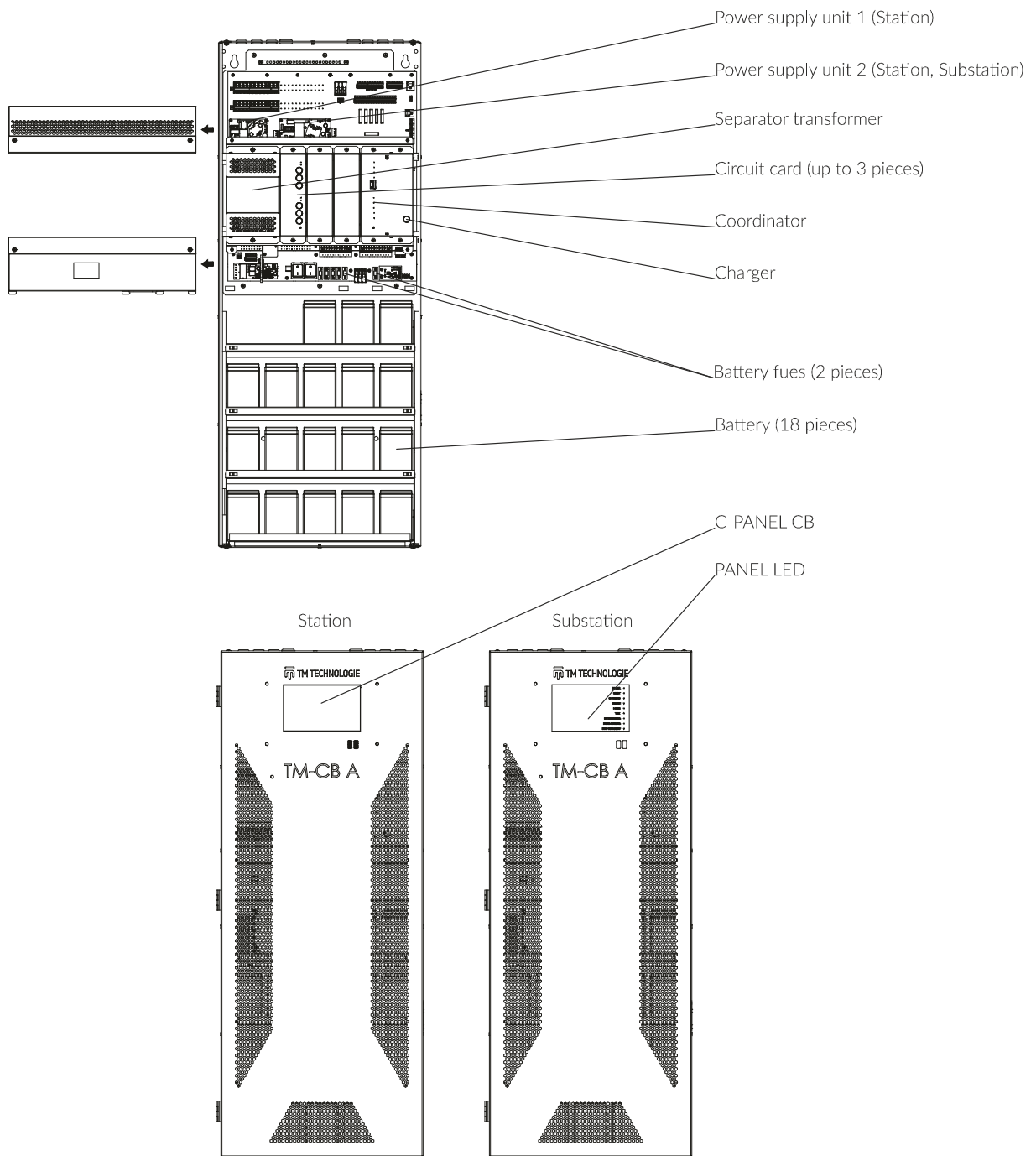

b) Version 10 circuits

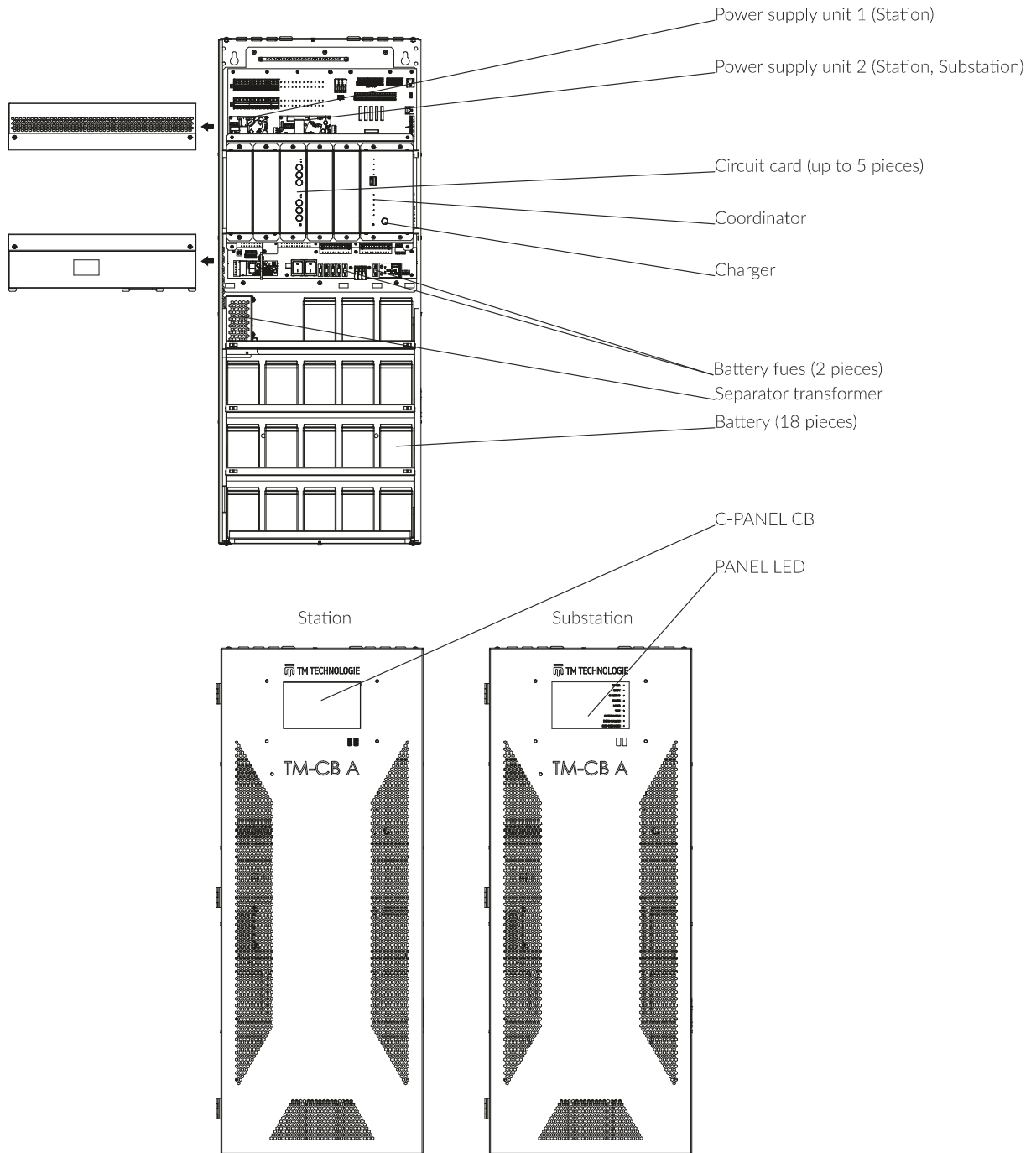

3.2. System Specification

In the case of failure of primary power supply, CB switches the load to battery power supply.

- ✓ Modular design of the system.
- ✓ Easy installation of cables, requiring no special tools.
- ✓ Possibility of using substations.
- ✓ Freely programmable operating mode for circuits.
- ✓ The maximum number of circuits is 640.
- ✓ Monitoring of circuits and fittings.
- ✓ Grounding monitoring.
- ✓ Mixed operation mode of fittings in one circuit.
- ✓ Up to 10 circuits per substation.
- ✓ Up to 20 fittings in one circuit.
- ✓ Up to 12 800 connected fittings.
- ✓ Ability to change the address on monitoring modules wirelessly.
- ✓ CC/CV charging increasing accumulator life.
- ✓ Touch panel computer.
- ✓ Intuitive and user-friendly setup.
- ✓ Protection against unauthorised access.
- ✓ Daily and annual tests controlled by a microprocessor.
- ✓ Storing reports on erroneous tests.
- ✓ Ability to connect to an Ethernet network.
- ✓ Connection with BMS via MODBUS TCP to the Intelligent Building Network.
- ✓ Embedded web page.
- ✓ Total Stop functionality (optional).

3.3. Substation Specification

Power supply	230 V AC / 50 Hz
Nominal voltage	216 V DC of accumulators
Accumulators	Maintenance-free accumulators (5 Ah or 7 Ah)
Number of circuits	6 or 10 with freely programmable operating mode
Cable gland	From the top
Insulation class	I
Protection degree	IP30
Housing material	Sheet steel
Dimensions	Cabinet SO 1005(1088*) x 410 x 197(210*) mm *dimensions including additional wall brackets
Accessories	C-PANEL CB, LED PANEL Modules for fitting monitoring
Standards	EN 50171 + EN 50272-2

3.4. System Versions

Central battery system can be made in several versions:

- a) **Basic** – only circuit monitoring.
- b) **Extended** – individual fitting monitoring.

Basic version

Only the current of some circuits is monitored. On commissioning, calibrations of output circuits are performed. Currents measured for the first time are regarded as default values. Circuit error is reported after the occurrence of deviation defined by the user. The system informs the user about the damage by stating the number of circuit where the failure occurred, e.g. damage to the ballast, burnout of the fluorescent lamp. It may be that only damage to 2-3 fittings will be reported – if wattages of fittings in the circuit are different. Therefore, for the basic version, it is not recommended to install fittings with different wattages in the single circuit.

Extended version

In each fitting, an addressable module is installed, which monitors the current. With this solution, the system can precisely inform the user about any faulty fitting. For example, the user receives a message of 64/24/20 fitting error, which means that the fitting in the substation 64, circuit 24 and addressed as 20 is damaged. Additionally, by using addressable modules, the user can freely configure the operating mode of fitting in the single circuit. No additional modules are required for fittings operating in maintained mode and supplied from the mains through a connector. Since each fitting in this mode has its control unit, it is possible to mix different versions (wattages) of fittings in the single circuit.

3.5. Current Loop

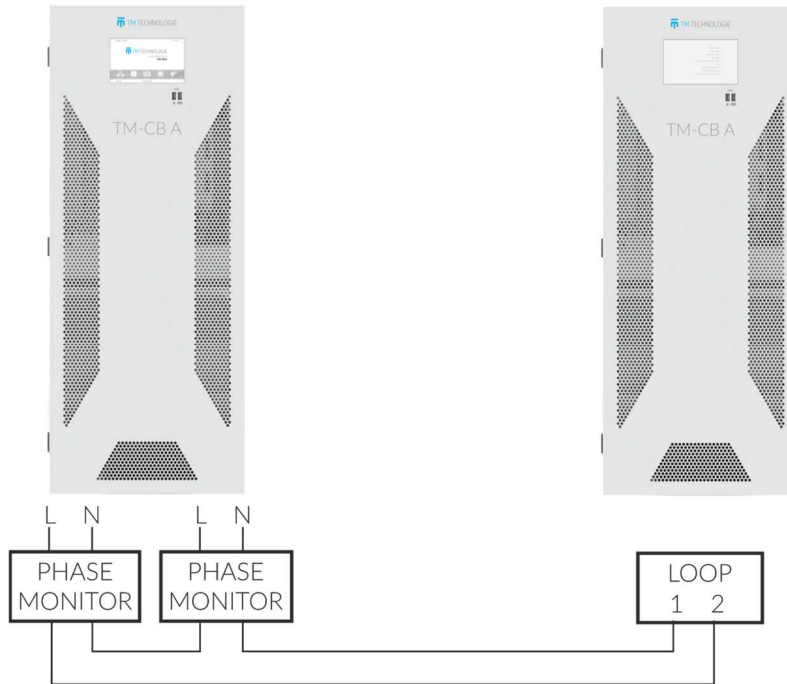

3.6. Total Stop

The Total Stop input is configurable. It can be used as a Total Stop or Phase Monitor input. The function can be selected from the control panel (see instruction manual of TM-CB A panel, chapter 6.5). In case of When using the Total Stop function below, the connector descriptions and connection diagram of the main station and substation.

Input L1 pins: „-” i „+” (connector X8)	12V separated voltage output pins: „-” i „+” (connector X7)
NOTE! See also chapter 3.7	

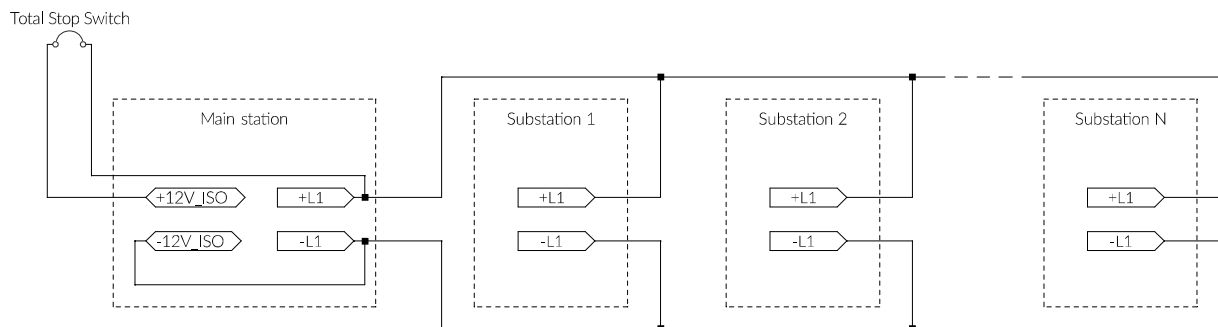

Circuit operation Voltage is 12 V.

Assumed current load in the circuit is equal 0,3 mA for main station and each connected substation. It is allowed to connect maximum 24 sub-stations to one 12V_ISO output from the station. Each total stop input is 230V AC tolerant. In case of wrong connected input – to 230 V AC will not cause damage. The Total Stop harness 0,5 mm² wires shall be used. Maximum length of wires is 2000 m. It means maximum distance between Total Stop switch and sub-station N is 1000 m. If longer distance is necessary the extra relay is required and another supplier form the sub-station connected according to diagram below. Please note that the relay causes extra load from the substation power supply.

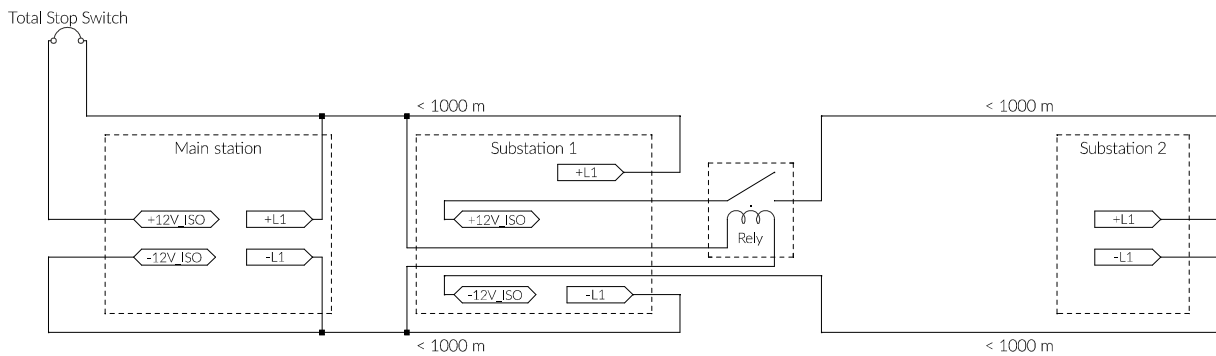

3.7. Description of outputs

Top PCB

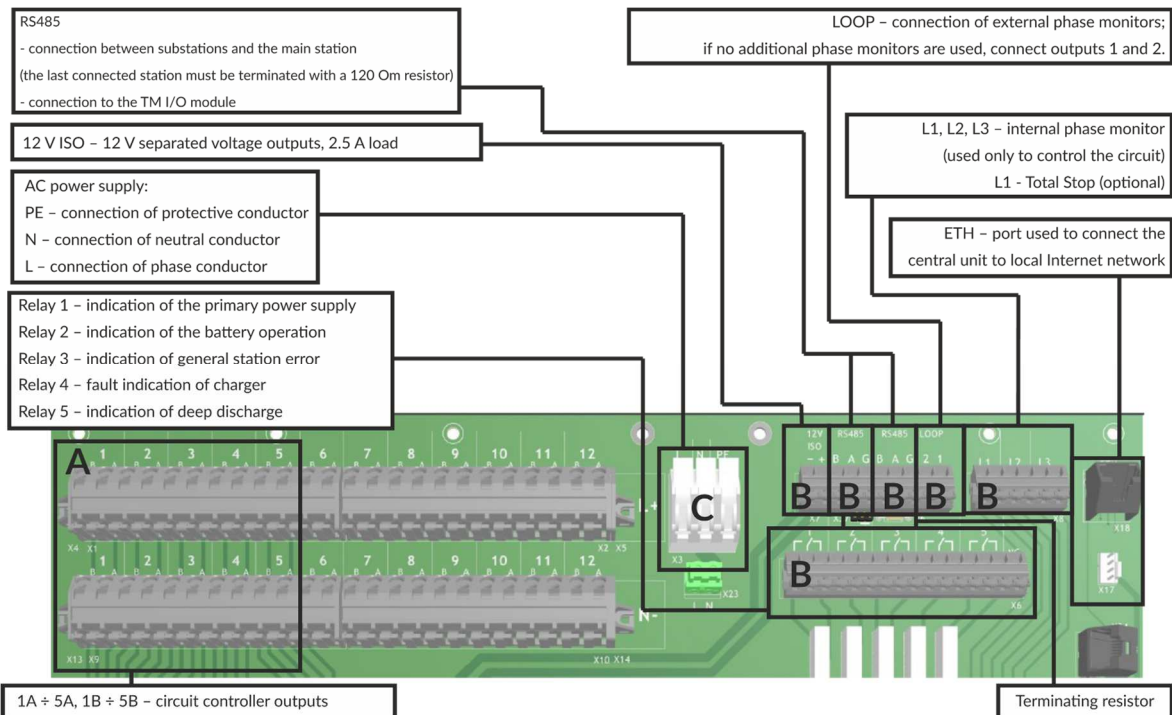

If a certain condition is fulfilled, the relay is switched over.

The relay is switched over when:

Relay 1:

Primary power supply; 1 and 2 closed, 2 and 3 open.

No power supply; 1 and 2 open, 2 and 3 closed.

Other outputs – similarly.

Bottom PCB

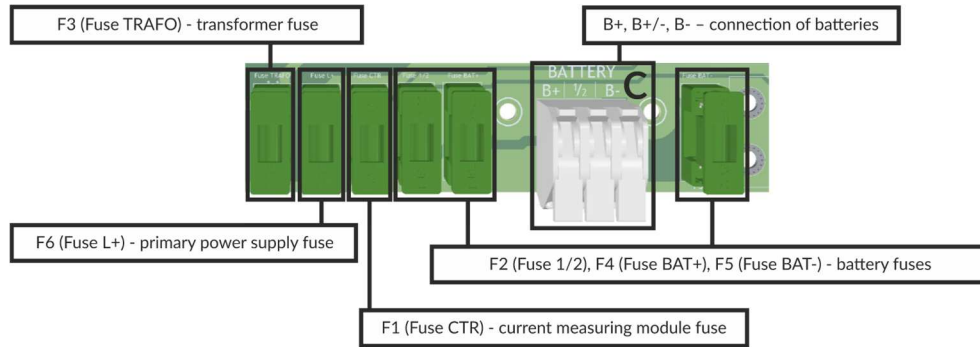

- A. WAGO 745-162 / 0.08 ÷ 4 mm² / 28 ÷ 12 AWG / 32 A / 1 kV
- B. WAGO 256-412 / 0.08 ÷ 4 mm² / 28 ÷ 12 AWG / 24 A / 630 V
- C. WAGO 2706-163 / 0.5 ÷ 6 mm² / 20 ÷ 10 AWG / 41 A / 1 kV

3.8. Fuse table

Fuse	Description on the PCB	Technical data	Manufacturer	Part number
F1	Fuse CTR	1A, quick blow, ceramic, extinguishing agent, 5x20mm	ESKA	520.517
F2	Fuse 1/2			
F3	Fuse TRAFO	5A, time-lag, ceramic, extinguishing agent, 5x20mm		522.724
F4	Fuse BAT+			
F5	Fuse BAT-			
F6	Fuse L+			
NOTE! The above fuses can be replaced with other ones, also certified, with equivalent characteristics!				
NOTE! Unauthorized repair of fuses is prohibited, as this may damage the device and cause a fire!				
NOTE! Always replace blown fuses with new ones!				

4. Safety Instructions

Read before installation

- The installation must be performed only when the power is turned off. Observe the safety rules of construction standards and regulations for electric installations.
- The battery central unit and the housing can be opened only by authorised personnel.
- Do not connect the power supply of the central battery to circuits which can be loaded with inductive receivers – this may damage electronic module of the fitting.
- The device is adapted for indoor use.
- The manufacturer reserves the right to change the design of the product.
- The manufacturer is not liable for any damage caused by connecting the product to faulty electric system.
- Ambient temperature: $T_a -5\text{ °C} \div +35\text{ °C}$.
- The system should be inspected after a longer power outage.
- The maximum time of power outage: up to 30 days.
- CR2025 or CR2032 battery type used in C-PANEL DATA CB is non-user replaceable part.

5. Instructions for Installation and Commissioning

Operations such as installation, commissioning and maintenance can be carried out only by the manufacturer, the manufacturer's service and competent personnel.

Before installing the device, make sure that the CB system is supplied with AC voltage and that the circuits are connected.

5.1. Unpacking and Arrangement

After unpacking, check that the product is not damaged and that all necessary accessories are available. Then, set the central battery at the installation site.

5.2. Mounting of the Cabinet

- Mounting cable glands.

Cut out the holes in the transparent protective film with a knife. Mount cable glands by pressing them in, through which the power supply cable and communication cables must be inserted.

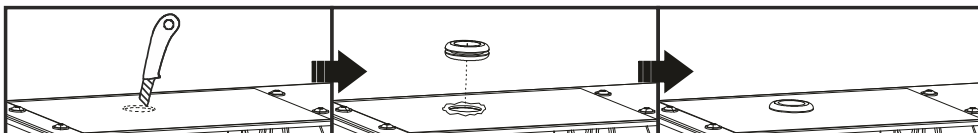

- Mounting of the cabinet on a vertical surface.

Mounting with 4 plugs and $\varnothing 8\text{mm}$ screws (the set does not include). Spacing of mounting holes is shown below: A=338mm; B=754mm; C=223mm.

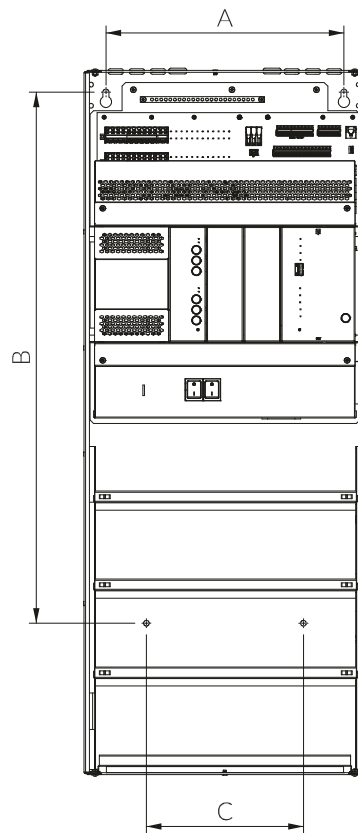

- Mounting of the cabinet on a vertical surface using additional external handles (in the set).

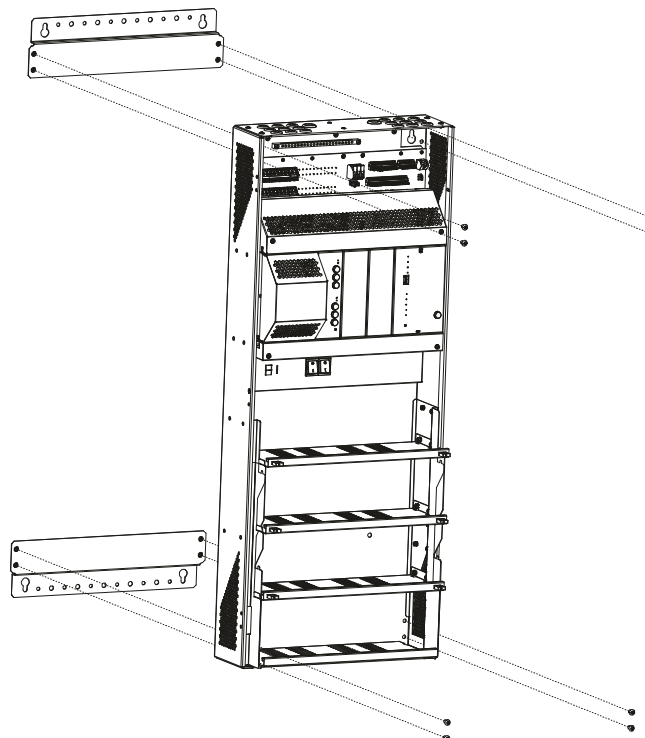

Mounting with 4 plugs and $\varnothing 8\text{mm}$ screws (the set does not include). Spacing of mounting holes is shown below: A=325mm; B=1060mm.

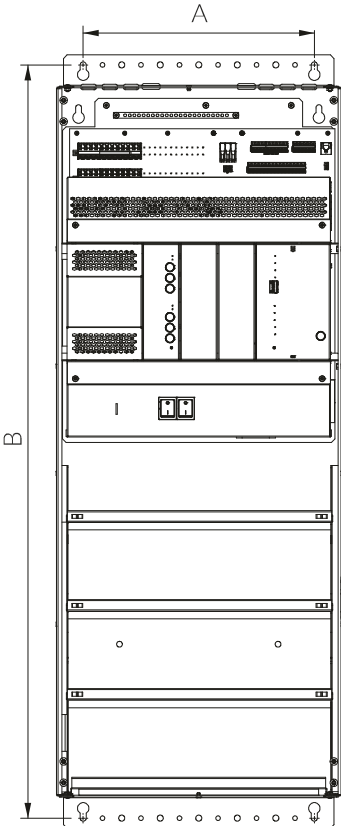

5.3. Installation of Accumulators

Accumulators can be installed only with F1 (Fuse CTR) (1A), F2 (Fuse 1/2) (1A), F3 (Fuse TRAFO) (5A), F4 (Fuse BAT+) (5A), F5 (Fuse BAT-) (5A), F6 (Fuse L+) (5A) fuses removed. Accumulators can be connected only in series (18 accumulators).

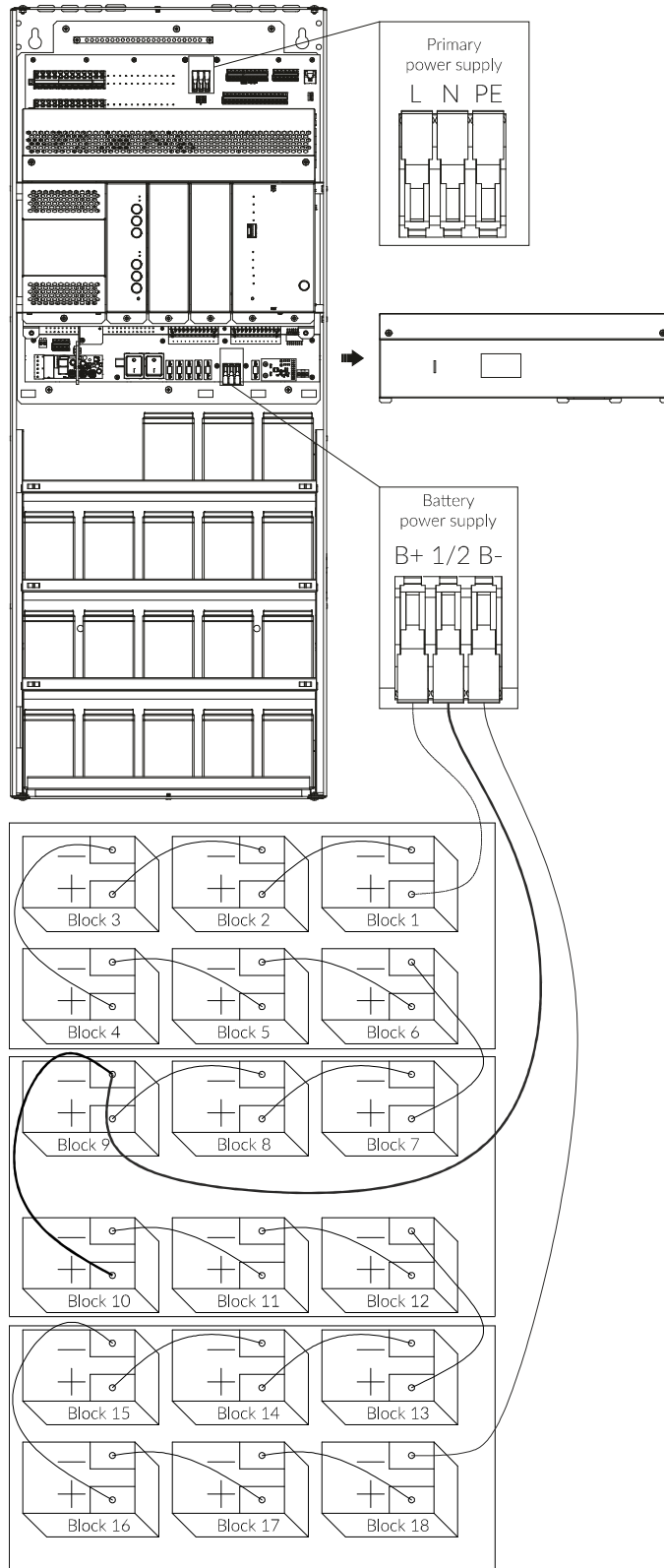

Keep the accumulator fuses removed until the final commissioning!

NOTE!

- ✓ Connect the accumulators (18 blocks for 12 V) in series, as shown in the figure on the previous page.

NOTE!
Connect the batteries only with the cables provided in the set.

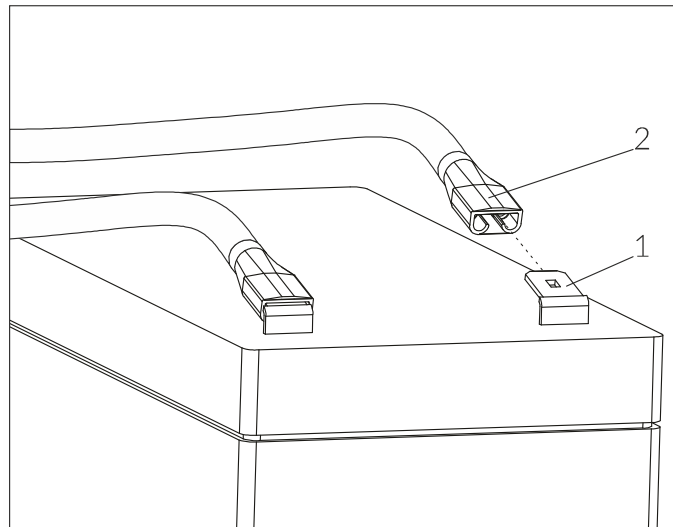

Connect the wires (2) to the battery connectors (1) by sliding them in.

- ✓ Connect the symmetry line of the monitored charging circuit from the accumulator block (block 9 (-)) to the corresponding symmetrical voltage connector (1/2)(+/-), as shown in the figure on the previous page.
- ✓ Connect the 1 accumulator block (+) to (B+) and 18 block (-) to (B-), as shown in the figure on the previous page.
- ✓ Check the polarity of the voltage and accumulators.
- ✓ Measure the accumulator voltage on fuses according to the diagram below.

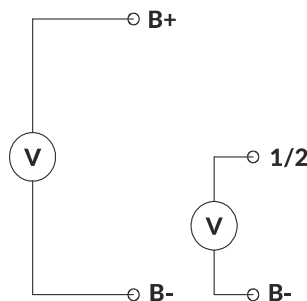

Voltage measured on the circuit (B+), (B-) should be positive. It should be 220 V +/- 30 V and approximately 2 times the voltage measured on the circuit (1/2), (B-).

An example of battery installation with cable routing and fixing in the TM-CB A S0 cabinet model S0710P is shown in the photo below.



5.4. Connection of Receivers

Check the end of the wire for insulation damage. Connect the fitting / fittings according to the diagram below. Use an HDGs type cable, wire cross-section $1.5 \div 2.5 \text{ mm}^2$ depending on the luminaire.

NOTE! The transmission range is up to 300 m with the proviso that the maximum power of luminaires installed on the perimeter is 140 W for 1.5 mm^2 and 230 W at 2.5 mm^2 .

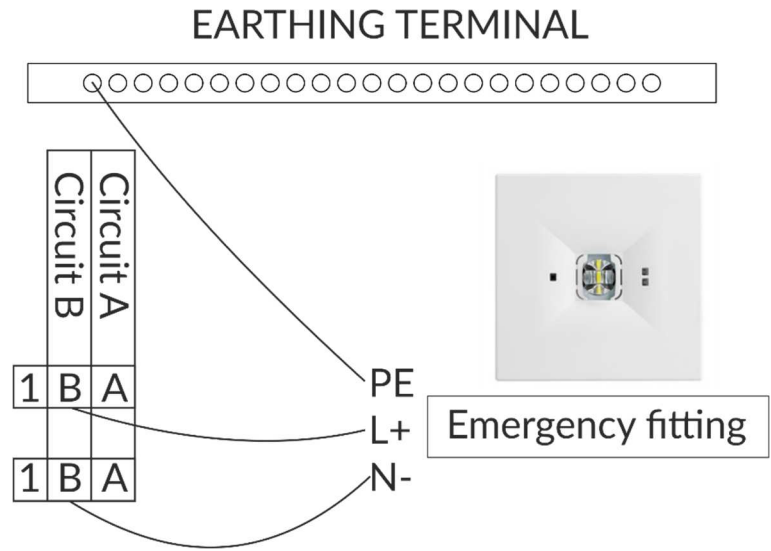

- ✓ Permitted topology of the power supply (communication) lines

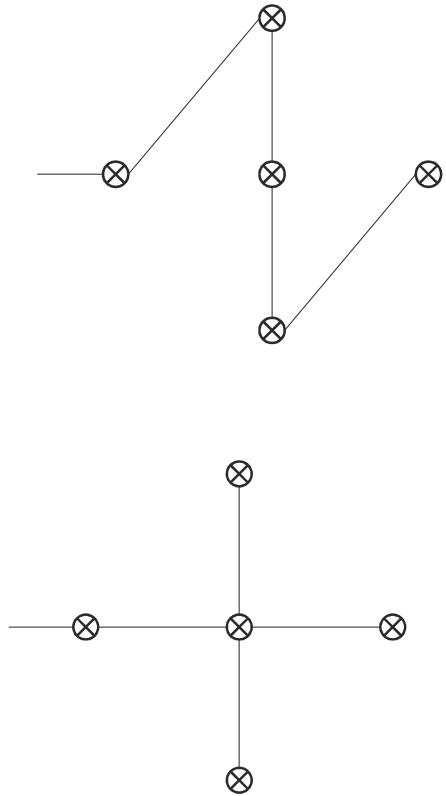

5.5. Connection of Devices

The connection to the system must be performed after disconnecting the power supply. TM-I / O module, addressable modules dedicated to TM-AM 02H, TM-AM 02V, TM-AM 03 and universal addressable module TM-AM 01, TM-AM 01S to be connected according to the attached instructions.

5.6. Connection of Substation

The substation should be connected to the main station (with a touch panel) with a suitable cable (BC-500, recommended parameters: wave impedance at $f > 100$ kHz: from 100 to 130 Ohm, capacity: 100 pF / m, cross section: 0.75 mm² or 0.8 mm²) or with a YTKSYekw cable 1x2x0.8 mm via a suitable cable using the RS485 bus. The appropriate terminals are shown in section 3.6 "Description of outputs" on the top PCB. At the last substation, set the 120 Ohm terminating resistor by placing a jumper on the T position of connector X37. The cross-section of wires can be from 0.5 mm² to 2.5 mm², and their maximum length should not exceed 1.2 km (from the main station to the last substation).

5.7. Installation of Fuses

Install the accumulator fuses F2, F4, F5.

5.8. Setting the Station Address

The station address is set using a DIP switch located on the charger and coordinator panel. The first switch has a weight of 1, the second of 2, the third of 4, the fourth of 8, the fifth of 16, and the sixth of 32. After the change, the address should be saved using the panel. The formula for the address is as follows:

$$1 + 1*W1 + 2*W2 + 4*W3 + 8*W4 + 16*W5 + 32*W6$$

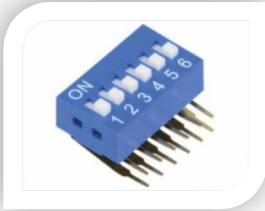
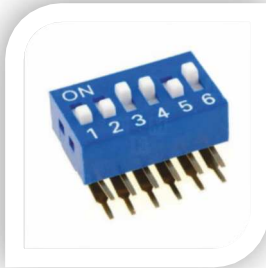
Visualisation	Address
	$1 + 1*0 + 2*0 + 4*0 + 8*0 + 16*0 + 32*0 = 1$
	$1 + 1*0 + 2*0 + 4*1 + 8*1 + 16*0 + 32*1 = 45$

5.9. Connection of AC Voltage.

It is shown in section "Installation of Accumulators". 1-phase power supply. To supply the S0 cabinet, use HDGs type cable, with a minimum cross-section of 2.5 mm².

5.10. Ethernet connection

The connection of the cabinet to the local Internet network should be carried out, for example, with a UTP cat 5e cable.

5.11. Connection of the internal phase monitor

Control the operation of circuits using a HDGs cable with a minimum cross-section of 1.5 mm².

5.12. Starting the System

Check that the screws are tightened and clamping connections are adjacent and clamped in the correct manner.

- ✓ Set the SERVICE MODE switch to “1”.
- ✓ Switch on the primary power supply, set the POWER switch to “1”.

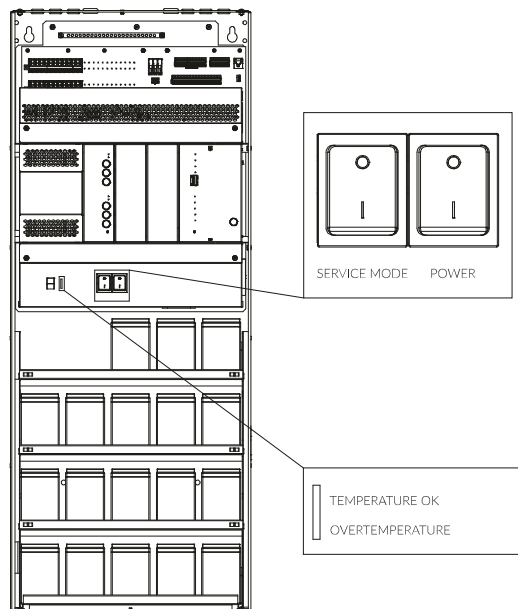

Possible messages (DEEP DISCHARGE) are due to the lack of battery or F2, F4, F5 battery fuse. The green LED (MAINS) must light up in any case.

NOTE! On the bottom panel of the main board the green diode "TEMPERATURE OK" indicates transformer temperature (<100 ° C) - lit from the moment the system is turned on.

NOTE! On the bottom panel of the main board, the lighting of the red diode "TEMPERATURE EXCEEDED" indicates that the transformer temperature has been exceeded (> 100 ° C).

NOTE! The central battery system has a two-position switch “SERVICE MODE” (lock) on the front panel. It is necessary that the switch is set to “0” during normal operation. Setting the switch to “1” disconnects the output circuits (operation in service mode – only battery charging). In this mode, the central battery cannot perform its function.

Accumulator activation and operational readiness

- ✓ Set the "SERVICE MODE" lock switch to "0" (normal operation).
- ✓ After a minute, CHARGING should start.

Configuration and operation check

- ✓ Check that the system has started up correctly and shows no errors (no messages on the panel).
 - ✓ Log into the system (Section 1. Getting started).
 - ✓ Perform a search / configuration of individual components connected to the system, maintaining the order:
 - searching for a station / substation (system menu) + configuration (Section 2.2),
 - circuit configuration (Section 3.3 Circuit configuration)
 - searching for luminaires (applies to addressable only, Section 3.1 List of Circuit + Section 3.6 Fitting Details),
 - searching for I / O modules (optional, Section 6.4 I / O modules).
 - ✓ Analyze the number of fittings installed in relation to the number of fittings found in the system (for addressable fittings), make sure that all fittings are powered and working properly, (all circuits can be tested brightly).
 - ✓ Carry out a calibration test if there are circuits on which power tolerance has been set (so-called circuit monitoring) - see Section 5.1 Manual tests.
 - ✓ Perform functional tests on all fittings in the system (Section 5.1 Manual tests).
 - ✓ Check the fittings for error after the test (Section 3.6 Fittings details).
 - ✓ If fitting errors occur, a local inspection should be carried out and the fitting should be checked for errors.
 - ✓ To confirm the correct operation of the system after installation, perform the following additional tests:
 - Set the lock switch to the 0 position and physically confirm that the fittings do not work in emergency mode after a power failure (the light source is off), after the test set the switch back to 1.
 - simulate the cabinet power failure and check if the message "power failure" appears in the form of a yellow horizontal bar on the main panel and the fittings are working properly,
 - in the selected fitting simulate damage to the light source by disconnecting / disconnecting it, perform a functional test and check its status (whether the damage condition is reported correctly), details (Section 3.6 Fitting details).
 - ✓ Set up test groups (Section 4.1 Test groups).
 - ✓ Configure the night groups (optional, Section 4.2 Night groups).
 - ✓ If the system is connected to an Ethernet network, configure the settings of the control panel network card.
- Enter the contact details of the building where the Central Battery System is installed (Section 7.5 Information).

- ✓ Generate a report in the control panel (Section 6.1 Reports).
- ✓ Prepare a report on the system startup work carried out and attach a generated report (in paper form) confirming the system status.

Now, the system is ready for operation.

NOTE! If the device has detected a charging error and the battery voltage is less than 210 V, the load will be disconnected in the event of a power failure.

NOTE! If the device has detected a charging error and the battery voltage is less than 205 V, the entire device will be disconnected in the event of a power failure.

NOTE!

Carry out the system configuration (setting of working time and battery capacity).

5.13. Turning the System Off (RESET)

- ✓ Set the “SERVICE MODE” switch to “1” (service mode active) and “POWER” switch to “0” and wait for all circuits will be disconnected (green LEDs on the circuit boards do not light up).
- ✓ Remove F2, F4, F5 accumulator fuses.
- ✓ Wait at least 10 seconds before restarting the system.
- ✓ To restart the system, follow the instructions given in sections 5.7 and 5.12 “Starting the System”.

5.14. Mounting USB end caps

- ✓ To achieve IP30 degree of protection it is necessary to mount USB end caps.

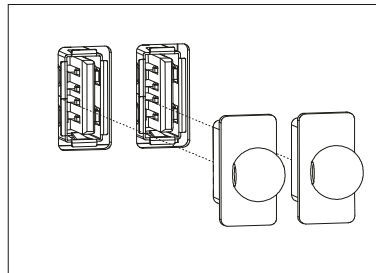

6. Storage Conditions

- ✓ Packaging with the device should be stored in a place protected against precipitations.
- ✓ Do not put anything on the packaging.
- ✓ Store the packaging in a dry environment, not exposed to moisture and chemicals, away from strong magnetic fields.
- ✓ Temperature: $+10\text{ °C} \div +25\text{ °C}$.
- ✓ Store in unit packages. Do not stack the packages.
- ✓ Store in original packaging.
- ✓ Storage conditions for accumulators are provided in section 7.2 related to accumulators.

7. Functions of Individual Modules of the System.

7.1. Charger

General Information

Electronic module used to charge the accumulator. Charges accumulator batteries with a given capacity at a specified time. The accumulators are impulse-charged with temperature compensation, which significantly extends their service life. Depending on the version, the maximum charging current is 2.5 A. The charger constantly monitors the charging current, accumulator voltage and temperature. It is a Plug&Play device. The device charges by adjusting the charging voltage to the cell temperature. In the case of an excessive heating of the charger, the charging current is automatically reduced. The module also includes a short-circuit protection fuse up to 3.15 A.

Proper operation of the charger is signalled by POWER and READY LEDs. If the charger is damaged, it is signalled by the FAILURE LED. CHARGING informs that the accumulators are currently charged.

Specification

- ✓ The integrated voltage monitoring.
- ✓ CV/CC charging characteristics – processor-controlled (no calibration is needed).
- ✓ The charger charges the accumulator to 80% (nominal capacity) for 12 h.
- ✓ The charger size is 1.5 U and it is mounted under the masking frame with the coordinator, making up 2 U in total.
- ✓ The primary voltage is supplied by a single-phase transformer.
- ✓ The accumulator charging is performed by a central control and monitoring unit. Ensures optimal accumulator life by taking into account the current, voltage, temperature, current state of charge.
- ✓ The adaptation of the control system to charge different types of accumulators is possible, trouble-free and performed through a central control and monitoring unit.
- ✓ The charger generates the charging current of up to 2 A for 250 V which adapts to the current accumulator level.
- ✓ The charging characteristics control is possible without independent control systems and is carried out using a computer. As a result, even in the case of computer failure, batteries are charged without any disruptions.

NOTE! The charger is available in two versions (PSU and PSU 2). The PSU version is used in six-circuit models (S0506; S0506P; S0706; S0706P) while the PSU 2 version is used in ten-circuit models (S0510; S0510P; S0710; S0710P).

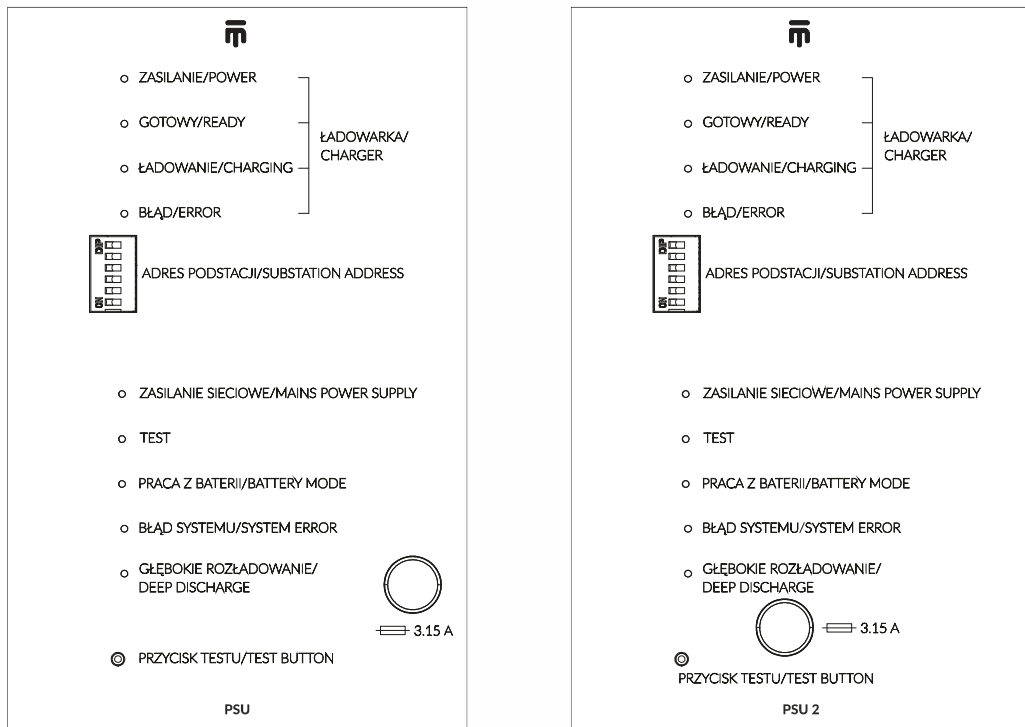

7.2. Accumulators

Accumulator battery

The battery consists of 18 maintenance-free lead-acid accumulators with a voltage of 12 V and application-dependant capacity. The capacity is determined taking into account a 25% reserve. Battery datasheets are available in attachments.

Maintenance rules

The accumulator is replaceable. Only the manufacturer, the manufacturer's service personnel or qualified staff may replace it.

- ✓ Check the accumulators for mechanical damage before their replacement.
- ✓ Excessive ambient temperature has a negative effect on the performance and service life of the accumulator.
- ✓ Soldering of accumulator connectors is not recommended.
- ✓ Connect accumulators using wires of the same length.
- ✓ Before starting, check if the polarity and connections are correct.
- ✓ Do not connect old and new accumulators. This may result in damage to accumulators and the battery-powered device.
- ✓ The battery must be replaced in the case of negative test results.

Storage

- ✓ Accumulators should be stored in a dry, cool place, away from direct sunlight.
- ✓ The optimal relative humidity during the storage is 55% +/- 30%.
- ✓ The accumulator storage time is dependent on ambient temperature. The table below shows the time after which the accumulator must be recharged with respect to its storage temperature.

Storage time (in months) after which recharging is required	Storage temperature [°C]
6	<20
4	20÷30
2	30÷40

After the time indicated in the table, the accumulator must be recharged with a voltage of 2.27 V / cell for 96 h or until the charging current is not changed within 3 h. Measure the voltage in the open circuit of the accumulator to determine whether it requires recharging. It is recommended to recharge the accumulator if the voltage drops below 2.07 V / cell. Failure to observe these conditions may result in a significant reduction of the accumulator durability and capacity.

Used accumulators are subject to waste disposal and must be deposited to local collection points.

7.3. Coordinator

General Information

It is a unit that controls the entire substation. The main element of the system, performing all control and monitoring functions. LEDs on the front panel constantly inform about the operating conditions of the station.

The basic functions of the coordinator are:

- a) Measurements of:
 - ✓ The charging current and accumulator battery discharge.
 - ✓ The battery voltage.
 - ✓ The battery symmetrical voltage.
 - ✓ The amplitude of the supply voltage.
 - ✓ The ambient temperature of the battery (external detector).
- b) Interaction with the user by displaying status information of the system on LED PANEL or C-PANEL CB located in the cabinet door (optional).

System status information with LEDs:

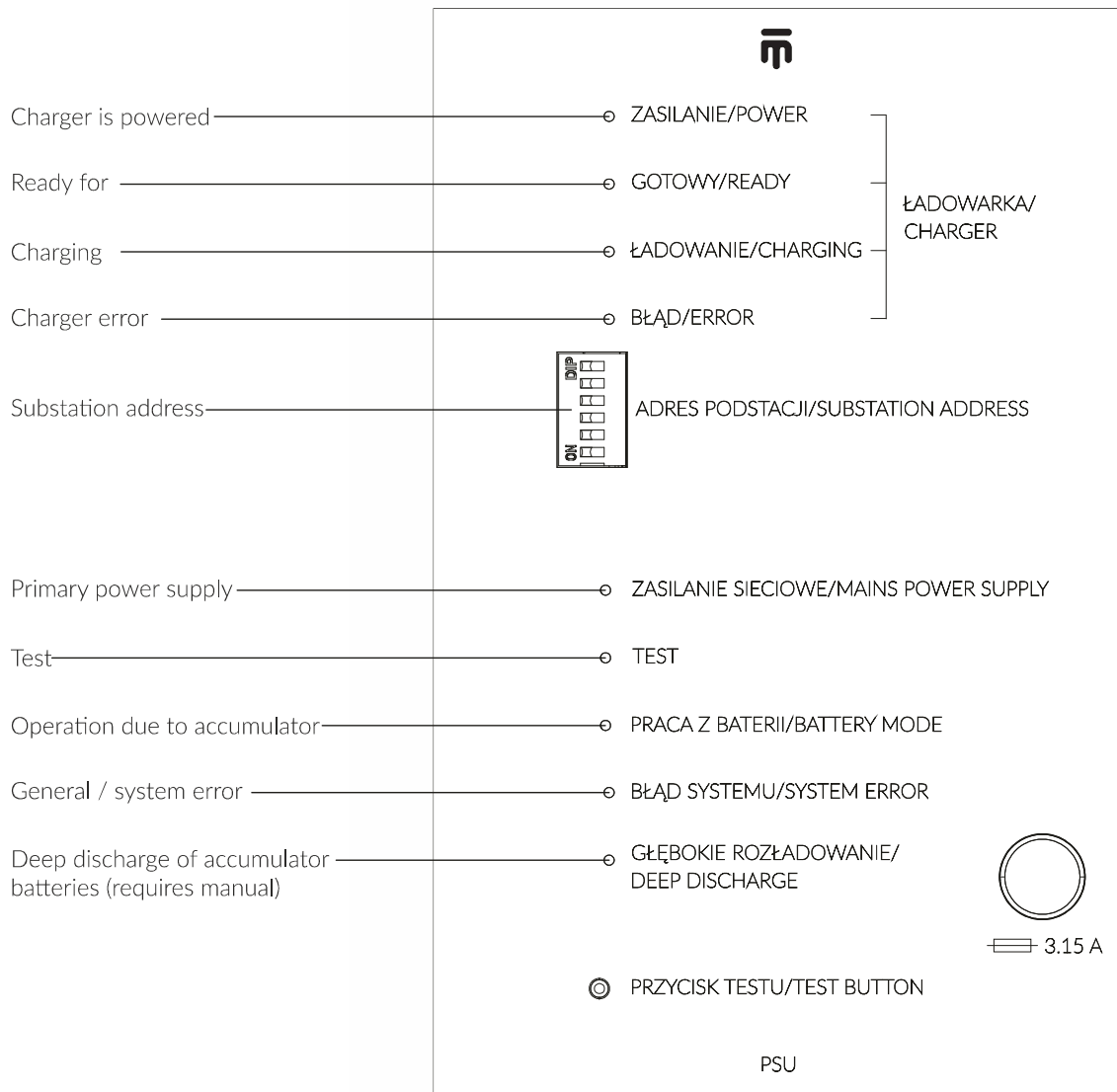

The TEST button is available only to the service personnel

Additionally, the panel has a button for triggering the test. If a user is logged in to the control unit, by pressing this button a function test of the station is triggered.

During normal operation of the system, only LEDs indicating the correct supply and charging of the accumulator batteries should be lit. Once the power is turned on and the accumulators are properly connected, charging should start after approx. 2 minutes. During the test, the TEST and BATTERY MODE LEDs light up, and the CHARGING LED goes off. If the system detects an error, the SYSTEM FAILURE LED lights up.

7.4. Circuit Controller

General Information

It is a device which controls the operation of output circuits. Depending on the operating mode, it supplies the proper voltage, controls the monitored fittings, measures the current, and activates the

modified mode for fittings. One circuit controller supports two output circuits. Depending on the **TM-CB A** type, a maximum of 5 or 12 cards of circuit controllers can be connected. Circuit controllers are automatically detected by the system.

Electrical circuits of the module are elements of the end circuit for **TM-CB A** emergency lighting systems.

The control and monitoring unit automatically identifies the card via the integrated Plug&Play system.

Electrical models of the systems are equipped with two electrical circuits ('Circuit A' and 'Circuit B'). Each circuit has a maximum load of 2.5 A. Additionally, each circuit has a ground control which indicates all possible faults in the end circuit by means of a red LED (error).

Programming of each lighting control mode in the end circuit is performed in a central computer separately for each circuit.

Possible errors and states of elements and electrical circuits, such as: the control mode for the receiver connected with an assessment of the receiver state, end circuit defects, etc., are displayed on the computer.

Specification

- ✓ 2 x 2.5 A output.
- ✓ Maximum load of up to 500 A with an integrated overload protection.
- ✓ Operation in the mixed mode in the end circuit.
- ✓ Fast, sand-filled fuse protecting end circuits: MCL – for one circuit, sand-filled, delayed action fuse 6xF3.15A.
- ✓ Supports two output circuits – protection for each circuit separately on L/+ and N/- line and accumulator.
- ✓ Configuration of the type of operation for each circuit.
- ✓ Integrated, calibration-based circuit monitoring.
- ✓ Built-in unit for the control of the damage to the ground wire.

LED signalling

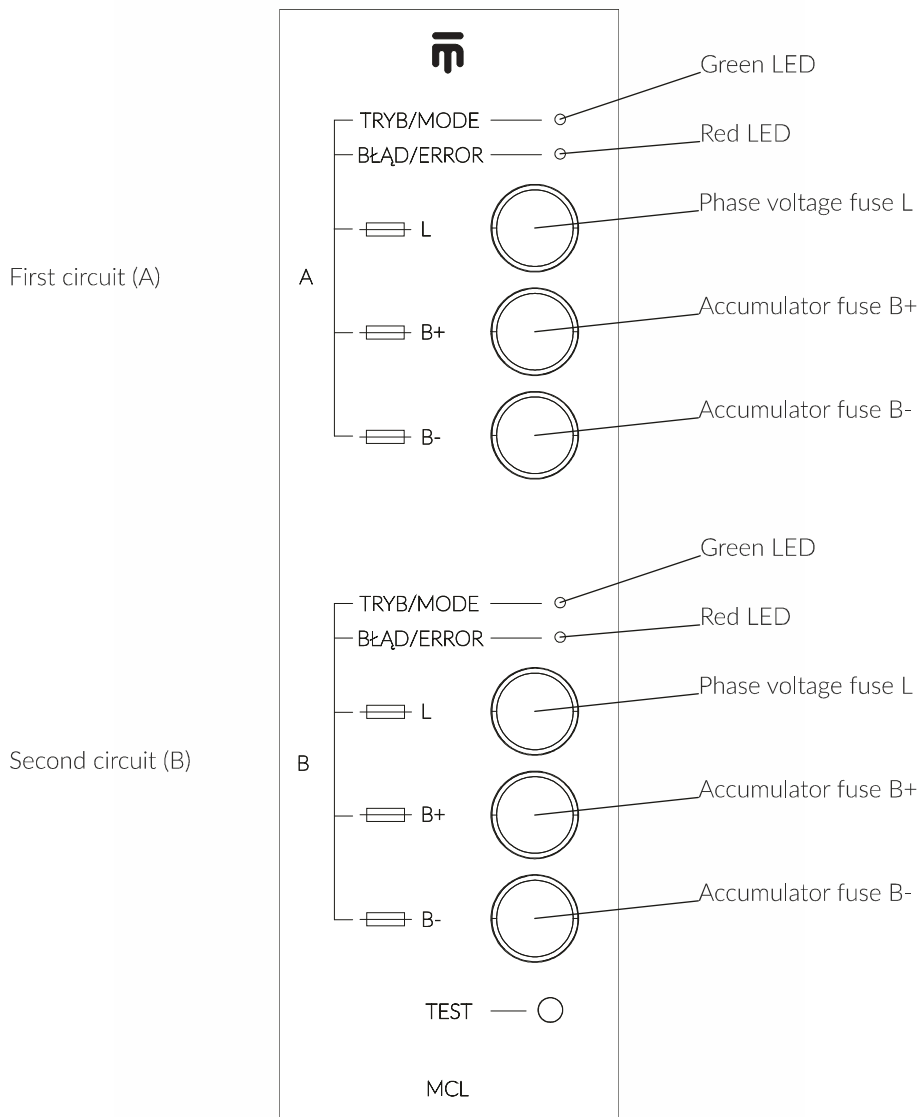

The TEST button is available only to the service personnel

Circuit A and B:

MODE - Green LED	FAILURE - Red LED
<ul style="list-style-type: none"> ➤ On – DC output voltage. ➤ Blinks shortly – (lighting time 0.5 s, period 5s) – no output voltage. ➤ Blinks slowly (lighting time 1 s, period 2 s) – AC output voltage. Normal operation mode of fittings. ➤ Blinks quickly (lighting time 0.1 s, period 0.2 s) – modified mode. AC output voltage. 	<ul style="list-style-type: none"> ➤ On – output voltage even after disconnecting the circuit. ➤ Off – everything is OK. ➤ Blinks quickly – (lighting time 0.1 s, period 0.2 s) – earth, fuse or relay fault.

NOTE! If all LEDs are lit, the card did not properly recognise its address. In this case, replace the card. If it is insufficient, contact the service.

Changing the operation mode of circuits

It is performed by means of the control device C-PANEL CB. Description is provided in appendix:

- ✓ C-PANEL CB – Instruction Manual

NOTE! In the case of changing the circuit load (e.g. by adding new fittings, changing the type of fittings, etc.), calibration is required.

During the (annual) inspection of the emergency lighting system, circuits should be re-calibrated after checking the condition of light sources. This allows to compensate the effect of their aging on the current drawn by them and, consequently, the possibility of erroneously determined circuit damage.

7.5. TM-I/O

General Information

The central battery system supports up to 16 TM-I/O modules. The modules connect with the control unit via the RS485 bus. The modules are supplied with 12 V.

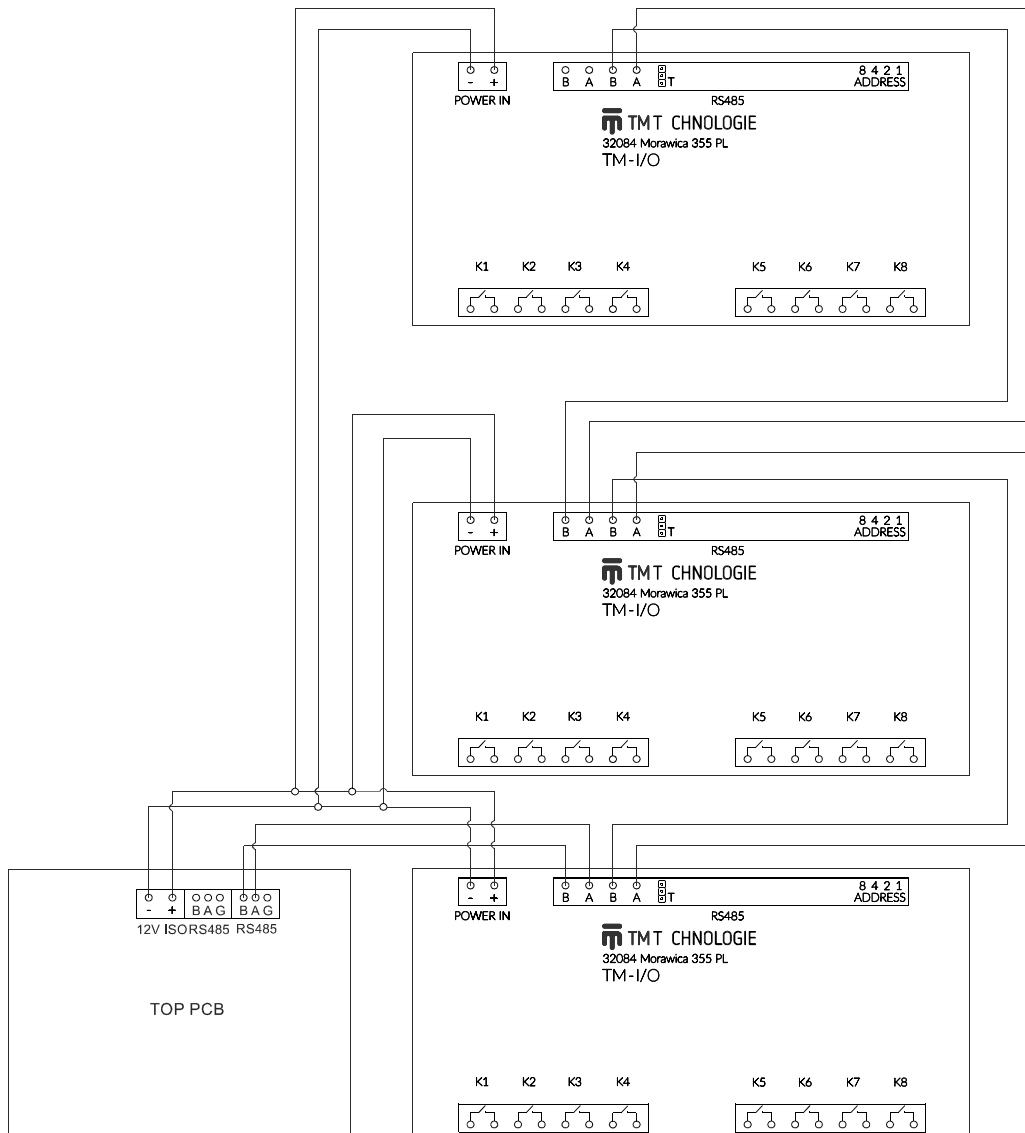

Address of modules is set with a DIP switch in the same way as on the card of the circuit coordinator. Addresses of connected TM-I/O modules cannot be repeated. In the absence of communication, check the polarity of RS485 wire. Searching for and configuration of modules is carried out in accordance with the C-PANEL CB control unit instruction manual.

The specification of universal addressable module is provided in appendix:

- ✓ TM-I/O – Instruction Manual

7.6. Dedicated Addressable Modules TM-AM 02H, TM-AM 02V, TM-AM 03

The specification of dedicated addressable module is provided in appendix:

- ✓ Configuration manual of addressable modules for TM-CB systems.

7.7. Universal Addressable Module TM-AM 01

The specification of the addressable module is provided in appendix:

- ✓ Data Sheet of TM-AM 01.

7.8. C-PANEL CB Computer



General Information

The system monitors the proper operation of the installed emergency lighting stations in large public buildings. It determines their condition by carrying out function and autonomy tests which are configured by the user. With this touch navigation and user-friendly interface, the system is exceptionally intuitive to use.

Specification

- ✓ Control via a touch panel with intuitive and user-friendly interface.
- ✓ Allows to configure the system operation.
- ✓ Preparation and storage of reports on the system operation.
- ✓ The full history of system events (tests, reports, logs).
- ✓ Password protection for different authorisation levels.
- ✓ Automatic and cyclic triggering of the station tests according to the schedule.
- ✓ Monitoring the system state through the website.

- ✓ Possibility of cooperation between the control unit and Intelligent Building Systems.
- ✓ Controls the substation operation.
- ✓ USB reader.
- ✓ Memory card allows to save the system configuration and event history.

It is a computer dedicated for the operation of the system. Integrated in the main station door. Can support up to 64 stations.

A detailed description is provided in annex:

- ✓ C-PANEL CB – Instruction Manual

9. Maintenance and Service

Proper operation of the system requires periodic tests and inspections. Tests are carried out automatically in accordance with separate regulations.

NOTE! To maintain the guarantee of correct operation of the system (which ensures the safety of evacuation of users facility), also being in compliance with legal regulations, it is necessary to conduct a system review no later than 12 months from the date of purchase of the first system components.

The following activities should be carried out during the inspection:

- ✓ Control of the system operation.
- ✓ Adjustment of the charging voltage.
- ✓ Measurement of the battery and accumulators voltage.
- ✓ Checking the level and specific gravity of the electrolyte (if required).
- ✓ Checking accumulator tightness.
- ✓ Testing the continuity of connections.
- ✓ Measurement of accumulator temperature.
- ✓ Recalibration of the system.
- ✓ And other activities required for proper functioning of the system.

Should you have any questions or doubts related to the operation of the system, please contact our service department:

TM TECHNOLOGIE Sp. z o.o.

32-084 Morawica



Morawica 355 near Krakow

tel.: +48 12 444 60 60, fax: +48 12 350 57 34

www.tmtechnologie.pl

10. Troubleshooting and Help

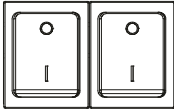
The following list will help you solve your problem. Otherwise, contact the manufacturer's service department.

Problem	Display	Possible cause	Solution
The unit does not start.		Primary power supply not available.	Check if external power supply is present and voltage is correct. Check fuse F6.
		Failure of the power supply unit	Contact TM TECHNOLOGIE's authorised service department.
The device is not working - non-maintained mode (battery power supply).	Coordinator panel - Deep discharge.	Too low accumulator voltage.	Accumulator must be recharged.
		Blown DC fuses.	Check DC fuses and fuse switches.
	 TRYB SERWISOWY ZASILANIE SERVICE MODE POWER	Service mode.	Set the switch to 0
No circuit function in the primary power supply.		Failure of the primary power supply.	Check the power supply.
		Service mode.	Turn off the service mode.
	OFF	Circuit is off.	
	OFF	Unconfigured circuit.	Switch the circuit for maintained operation.
	NM	Circuit for non-maintained operation.	
	X	The circuit operates in modified mode.	Improper configuration. External triggering.
	Red LED is blinking.	Fuse error. Earth fault. Defective card.	Replace the fuse. If insufficient, replace the card.
No circuit function in the battery power supply.		Service mode.	Turn off the service mode.
	OFF	Circuit is off.	Switch the circuit for maintained/non-maintained operation.
	OFF	Unconfigured circuit.	
	Red LED is blinking.	Fuse error. Earth fault. Defective card.	Replace fuses. If insufficient, replace the card.

	Green LED Green LED LED is off Red LED	● POWER ● READY ○ CHARGING ● FAILURE	Blown fuse	Replace fuses.
No accumulator charging (signalled by the charger).	Green LED LED is off LED is off Red LED	● POWER ○ READY ○ CHARGING ● FAILURE	Uncalibrated device.	Contact TM TECHNOLOGIE's authorised service department.
	LED is off LED is off LED is off Red LED	○ POWER ○ READY ○ CHARGING ● FAILURE	Charger communication error.	
			Accumulators error. Fuse error.	Check and replace defective fuses.
			Accumulators error.	Replace defective accumulators.
			Accumulators error. No connection.	Properly connect the accumulators.
The circuit operates despite open critical loop or triggering from the TM-I/O module.			Poorly connected or configured module.	Check the connection or configuration.
Device is off at primary power supply failure.			No accumulator connected or blown fuse.	Check accumulators, fuse and replace defective components.

Instruction Manual of
TM-CB A Panel
v0.10 05-06-2019



Table of Contents

1.	Getting started	3
2.	System	4
2.1	Station Details.....	6
2.2	Station Configuration.....	7
2.3	List of Errors.....	8
3.	Circuits.....	9
3.1	List of Circuits.....	9
3.2	Circuit Details	11
3.3	Circuit Configuration.....	13
3.4	Configuration for external triggering	14
3.5	Change of the night group	15
3.6	Fitting Details.....	15
4.	Groups.....	18
4.1	Test Groups.....	18
4.2	Night Groups.....	19
4.2.1	Timer Mode.....	20
4.2.2	Dimming Mode.....	21
4.3	Adding Multiple Circuits to Groups.....	22
5.	Tests.....	23
5.1	Manual Tests.....	23
5.2	Test in Progress.....	24
5.3	Test History.....	24
6.	Organizer	26
6.1	Reports	27
6.2	Logs	28
6.3	Timers	30
6.4	I/O Modules.....	31
6.4.1	Input Module (IN SW, IN 24, IN 230).....	31
6.4.2	Output Module (OUT).....	32
6.4.3	Error Messages.....	33
6.5	Backup	34
7.	Settings.....	34
7.1	Users	35
7.2	Network.....	36
7.3	Panel.....	37
7.4	Time.....	38
7.5	Information.....	39
8.	Website	40
9.	USB devices	41
10.	Important information	41
11.	Modbus	41
11.1	Introduction to Modbus communication	41
11.2	Modbus register map	42
11.3	Station status	43
11.4	Circuit status	44

1. Getting started



To start operation of the system, log on using one of the following accounts:



- **admin** – intended for manager/supervisor (the default password to this account is '1234'),
- **service** – intended for authorised service centre of TM Technologie.



If no user is logged in, it is possible to view the system status without making any changes. The login window is available after clicking '**log in**'. The login and password consist of at least four alphanumeric characters. During the control unit setup, change the admin password and create your own user accounts.

Note! Log out after making any changes to the system.

If an error occurs in the system, a red bar with an information on irregularities detected is displayed. After selecting this bar, the user is taken to a location where the error cause can be diagnosed. Yellow horizontal bar informs the user about the need to carry out the inspection, about a power failure, service mode, delay after breakdown or at least one unconfigured station.

The following indicators are available on the home page:

-  **system** – general information about the system,
-  **circuits** – information about circuit controllers,
-  **groups** – viewing and modifying groups,

-  **organizer** – access to modules that control the system,
-  **settings** – panel configuration.

2. System

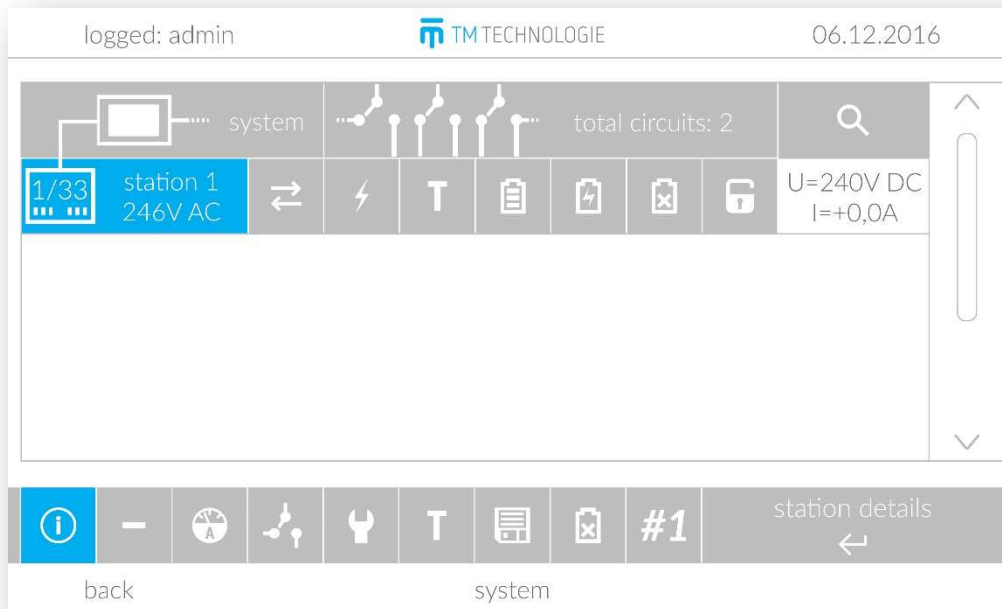

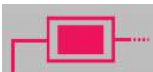

The “system” menu allows to quickly determine the system status. The first line shows information about the current state of the system, number and status of all circuits – and subsequent lines – a list of stations added to the system.

The “system” icon informs on the two possible states of the device:

-  - system shows no errors,
-  - system shows errors.

The “total circuits” field shows the number of all circuits in the system and information on their status:

-  circuits show no errors,
-  circuit/circuits show errors.



 allows to search for and add stations to the system.

Each line is a substation and contains information about:

















- station status ( - station ok,  - station error); next to it there is an information on the basic power supply voltage.

Station error indicates one of the following errors:







- general error,
- long test error,
- circuit error,
- unconfigured station

-  - 1*/33** - station set for working time *1 (or 2 or 3) hour and battery capacity **33 (or 7 or 12 or 18 or 24 or 26) Ah,
-  - X/XX - unconfigured station.

Note! The newly added station is unconfigured and its parameters must be set in the menu (see section 2.2 - operating time and battery capacity).

- communication status ( - ok,  - no communication),
- power supply status ( - basic power supply,  - no basic power supply),
- test status ( - last test correct,  - station test in progress,  - test error),
- battery mode ( - normal operation,  - battery mode),
- charger state ( - no charging,  - charging in progress,  - charger error),
- deep discharge ( - batteries are in working order,  - batteries after deep discharge),
- service mode ( - station is not in service mode,  - station is in service mode),
- voltage and battery current or if critical loop is open.

After clicking on the station, it is possible to:

-  change the station description,
-  remove the station from the control unit,
-  read specific parameters of the station,
-  read circuit information,
-  configure parameters of the station,
-  go to the station test menu,

- preheating – time of fitting heating before the test,
- circuits shutdown voltage – batteries voltage below which circuits are disconnected in the absence of basic power supply,
- total shutdown voltage – batteries voltage below which the station is shut down in the absence of basic power supply,
- AC switch threshold – voltage of basic power supply below which the system switches to battery operation,
- failure test voltage – batteries voltage that should be obtained after 2/3 of the nominal duration of the test,
- adc parameter – parameter for service.

2.3 List of Errors

logged: admin		TM TECHNOLOGIE	06.12.2016
deep discharge			no
batteries error			no
symmetrical voltage error			no
cell temperature exceeded			no
charger error			no
charger communication error			yes
charger fuse error			no
station overcurrent			no

delete errors

enter
←

back station errors 1

List of errors detected in the substation. Once the fault is remedied, the user must manually reset errors.

- deep discharge – batteries voltage below 205 V,
- batteries error – batteries voltage is too low,
- symmetrical voltage error – symmetrical voltage is outside the acceptable range,
- cell temperature exceeded – batteries temperature is outside the acceptable threshold,
- charging error – damage to the charger,
- charger communication error – no communication with the charger,
- charger fuse error – defective fuse in the charger,
- station overcurrent – too high station current was detected.













3. Circuits

3.1 List of Circuits











The circuit window allows to preview the state of circuits installed in the system. Click on the station/group to collapse/expand the list. Click on the circuit on the list to display detailed information.

Each circuit item on the list informs on:



- general circuit state ( - ok,  - disabled or unconfigured,  - error),
- physical address of the circuit, e.g. 01/12A, which informs that it is the circuit A on the controller no. 12 on the substation no. 1),
- communication status ( - ok,  - error),
- active search of the fittings (),
- circuit output voltage ( - no voltage,  - DC,  - AC),
- card state ( - ok,  - error),
- default operating mode of the circuit (**OFF** - disabled or unconfigured, **NM** - non-maintained operation, **M** - maintained operation),
- circuit test status (**T** - test ok, **T** - test in progress, **T** - test error),
- result of current measurement in the last test ( - result ok,  - error),

- circuit off state ( - circuit is disabled,  - circuit is enabled);



the circuit signals the off state when it is:



- unconfigured,
- disabled,
- in service mode,
- the installed fittings with an address module, their number and state (no icon – circuit without addressable fittings,  - fittings ok,  - faulty fittings),
- assignment to a night group (no icon – circuit is not assigned,  – assigned to a night group). When the circuit is assigned to a night group, the system displays information about the night group. If the night group icon  changes to , the circuit is activated by this night group. The night group has a higher priority than the basic configuration of the circuit (M/NM),
- circuit configuration for external triggering (no icon – unconfigured,  – configured). If  appears next to this icon, the circuit works in a modified mode. If  is displayed, the circuit is off. External triggering has a higher priority than the night group and basic configuration.

The toolbar allows to:

-  enable filtering of the circuit list (the system displays only those fittings with a particular error, tested fittings, or unconfigured fittings),
-  change the display of the fitting list (list by topology and list by night groups are available),
-  search for fittings in the system.

Available filters:

-  communication error,
-  controller error,
-  test error,
-  in-test,

-  load current error,
-  unconfigured circuits.

3.2 Circuit Details

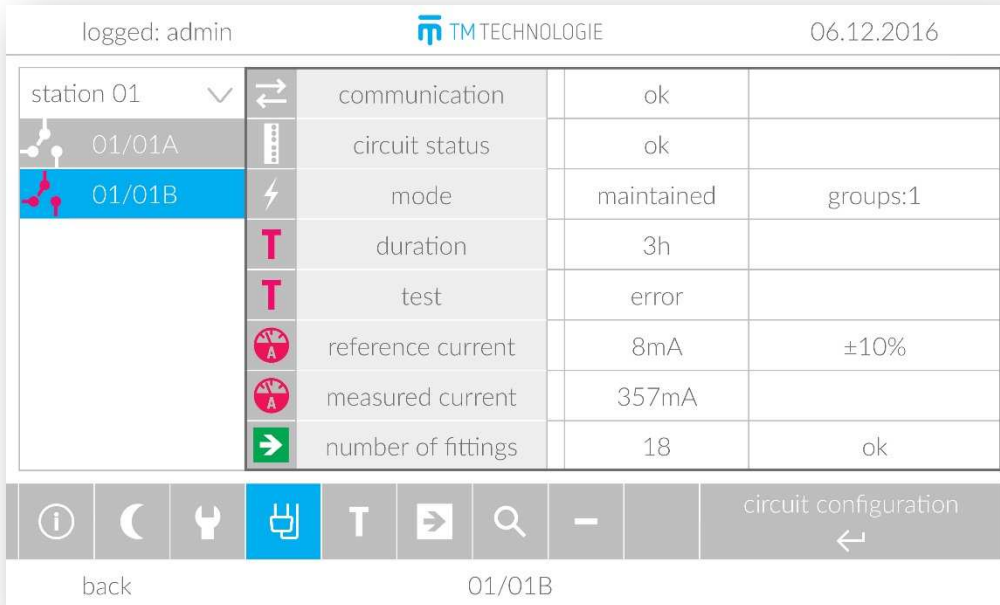









station 01	communication	ok	
01/01A	circuit status	ok	
01/01B	mode	maintained	groups:1
	duration	3h	
	test	error	
	reference current	8mA	±10%
	measured current	357mA	
	number of fittings	18	ok

The “details” tab shows extended information about the circuit. The following information is available:

- communication – circuit communication status,
- circuit status – circuit operating status; if an error is detected on the circuit, the error cause is displayed as the following abbreviation:
 - AC – no AC voltage detected at the output despite the activation – possible L fuse blow,
 - DC – no DC voltage detected at the output despite the activation – possible B+ or B- fuse blow,
 - R – no voltage detected despite the activation – possible card failure,
 - M – the circuit does not detect the basic power supply – possible card failure,
 - GR – ground control – possible isolation fault,
 - I – too high current was detected.
- mode – selected operating mode of the circuit (unconfigured / disabled / maintained / non-maintained / modified / service mode) next to the night group no., if the circuit is assigned),
- duration – work time after which the circuit is switched off during non-maintained operation,

- test – shows information about the test result or whether the circuit is currently tested,
- reference current – current measured during the calibration test, used as a reference for subsequent tests; next to it, the system displays an acceptable tolerance,
- measured current – current measured during the last test; if test or power failure actual measured current,
- number of fittings – number of fittings monitored on the circuit; next to it, the system informs whether all fittings are operational.

The user can perform the following actions on the circuit:

-  change the circuit description,
-  change the circuit night group,
-  configure the circuit,
-  configure the circuit for external triggering,
-  perform circuit test,
-  display detailed information on fittings
-  search for fittings on the circuit,
-  remove all fittings from the circuit.

3.3 Circuit Configuration

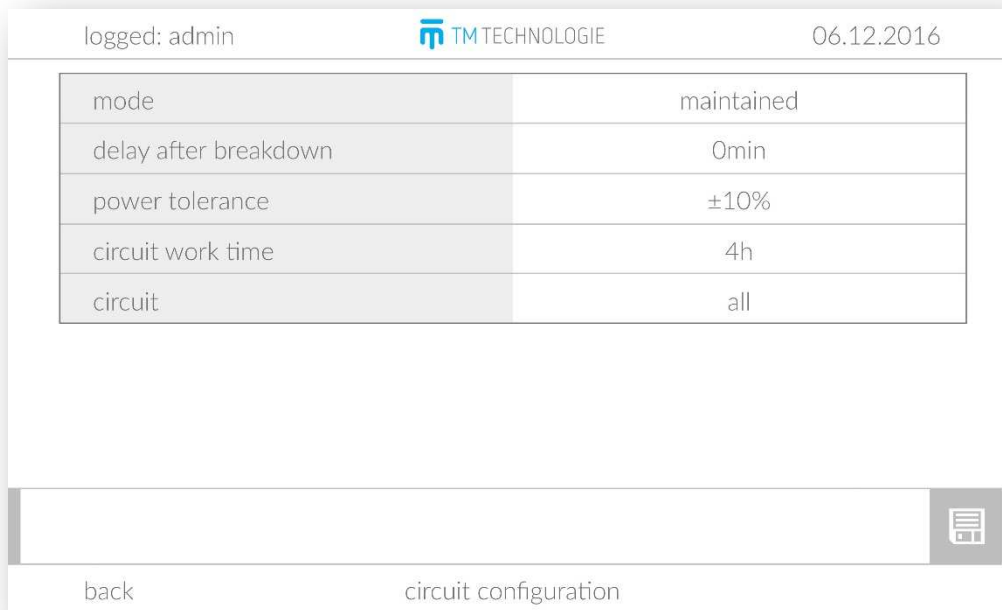

parameter	value
mode	maintained
delay after breakdown	0min
power tolerance	±10%
circuit work time	4h
circuit	all

The window allows to change the operating parameters of the circuit:

- mode – basic operating mode of the card:
 - unconfigured – the circuit has not yet been configured or the circuit controller is to be removed from the substation; the circuit does not supply voltage at the output and does not switch to non-maintained mode,
 - disabled – the circuit is switched off; the circuit does not supply voltage at the output and does not switch to non-maintained mode,
 - maintained – the circuit works in continuous mode, supplies the AC voltage during normal operation, and the DC voltage in the event of basic power supply failure,
 - non-maintained – the circuit works in discontinuous mode, no output voltage during normal operation, DC voltage in the event of basic power supply failure,
 - delay after breakdown – time expressed in minutes that must elapse for the circuit to switch to normal operation when the basic power supply is restored (0-30 minutes),
- power tolerance – tolerance with which the current measured in the test will be compared to the reference value (5-50%); if the value is set to zero, currents will not be compared after the test,
- circuit work time – work time after which the circuit is switched off during non-maintained operation (1-8 h).

Note! You can't change the circuit setting when the station is not configured, an appropriate message will be displayed.

3.4 Configuration for external triggering

no.	I/O module	in	action	no.	I/O module	in	action
1	internal	L	1 on	5	off	---	off
2	external	1	2 off	6	off	---	off
3	BMS modbus	---	2 off	7	off	---	off
4	off	---	off	8	off	---	off

The window allows to configure the operating status of the circuit to respond to external triggering. The user can control the circuit via the internal phase loss detecting module or the external I/O module.

Additionally, it is possible to control the circuit from the BMS system via the Modbus TCP protocol. The user can configure up to 16 triggering operations.

Firstly, the user configures the I/O module for each of the 16 inputs:

- disabled – the input is off, the remaining configuration is not taken into account.
- internal – phase loss detecting module is installed on the substation. In this case, the “in” indicates the input number (1-3).
- external – I/O module added to the system in the organizer / I/O modules tab; additionally, the module address must be set in the second column. The “in” indicates the input number (1-8).
- BMS – control via the Modbus TCP protocol. The “in” indicates the bit number.

Then, the user configures whether the input is to trigger modified mode at the circuit output or disconnect the voltage. If at least one input triggers modified mode, the remaining inputs are no longer taken into account. Modified mode takes priority over the off-mode.

3.5 Change of the night group

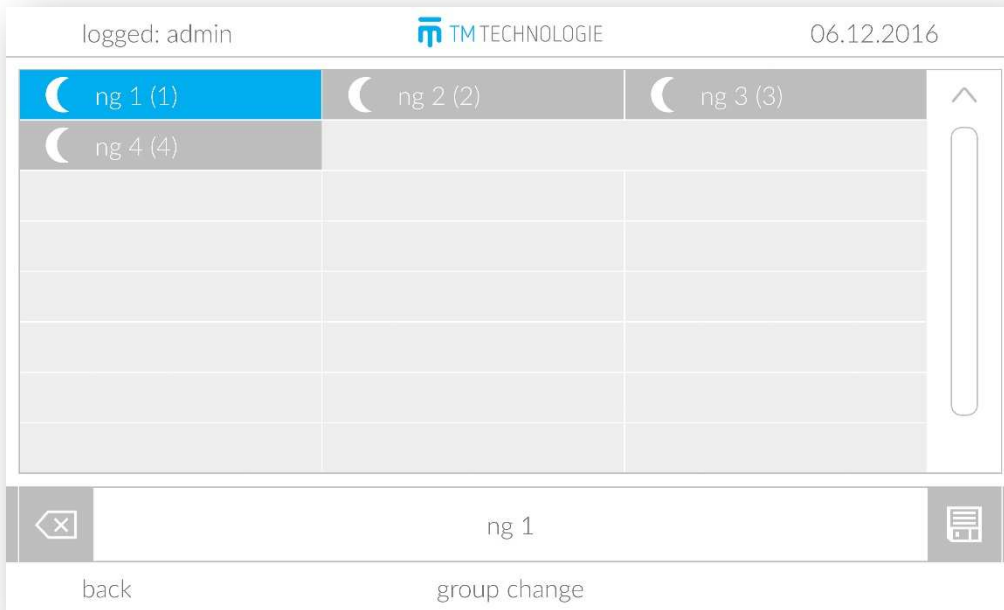

In the circuit details window, after selecting the group change option, the system displays a list of available groups. To change the group, select another group and confirm the change by pressing . To remove the circuit from the group, press the cross icon on the toolbar and confirm.



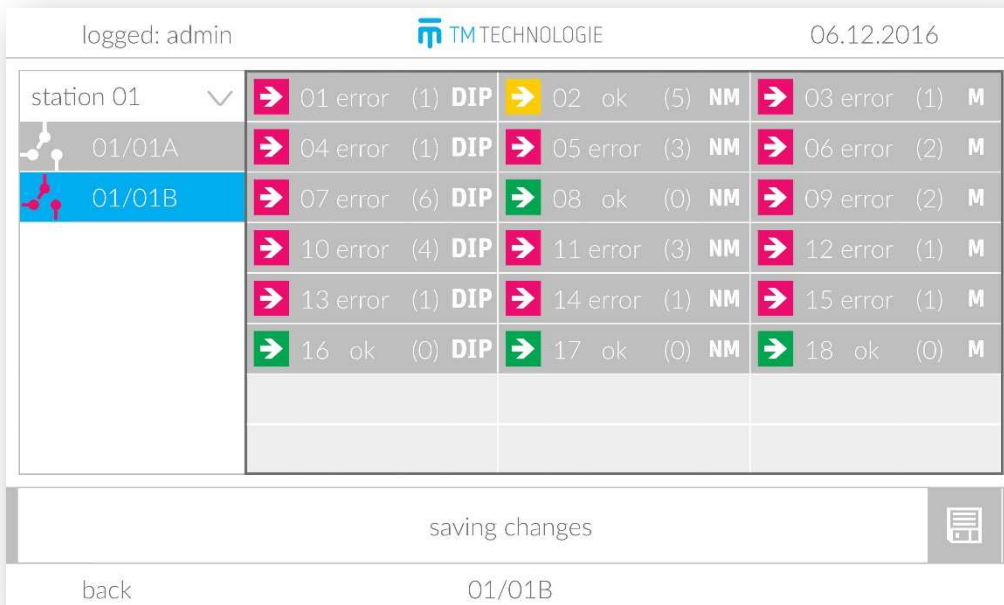



3.6 Fitting Details























After selecting fitting details, the system displays a list of fittings monitored from the circuit.

The maximum number of fittings is 20. The list shows the number of fitting, its status, and configured operating mode.

Fittings designation:





-  fitting ok,
-  fitting added and untested,
-  faulty fitting,
-  fitting operates according to dipswitch settings on the address module,
-  fitting configured for maintained operation (the circuit must also operate in maintained mode),
-  fitting configured for non-maintained operation,
-  fitting configured for removal.

logged: admin TM TECHNOLOGIE 06.12.2016

station 01	 01 error (1) DIP	 02 ok (5) NM	 03 error (1) M
 01/01A	 04 error (1) DIP	 05 error (3) NM	 06 error (2) M
 01/01B	 07 error (6) DIP	 08 error (1) NM	 09 error (2) M
	 10 error (4) DIP	 11 error (3) NM	 12 error (1) M
	 13 error (1) DIP	 14 error (1) NM	 15 error (1) M
	 16 ok (0) DIP	 17 ok (0) NM	 18 ok (0) M

NM
01/01B/08
i

back 01/01B

After logging in, the user can change the configuration of the fitting operation. It is necessary to select the frame and in the menu we have to choose the change of the work mode ,  and change the description , in addition, the name of the binding is printed in the middle. After changing the operating mode, the record icon is activated on the right .

Error codes of fittings lightings:

- 0 – result of the test ok,
- 1 – test error – the current or voltage of the light source is outside the threshold,
- 2 – no communication with the fittings,

- 3 - test error due to circuit error - DC can't be connected / circuit isolation control error,
- 4 - communication error with RFID memory,
- 5 - newly added fitting, has not passed any test yet,
- 6 - dubel - at least two fittings were detected on the line with this address.

4. Groups

After selecting the group indicator in the main window, the user can go to one of the following two groups:

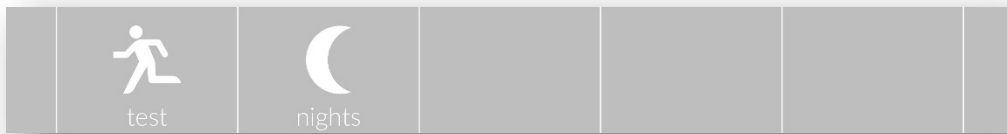

- **test groups** – used to automatically trigger function or autonomy tests,
- **night groups** – used to configure the control of circuit operation (enabling maintained operation).

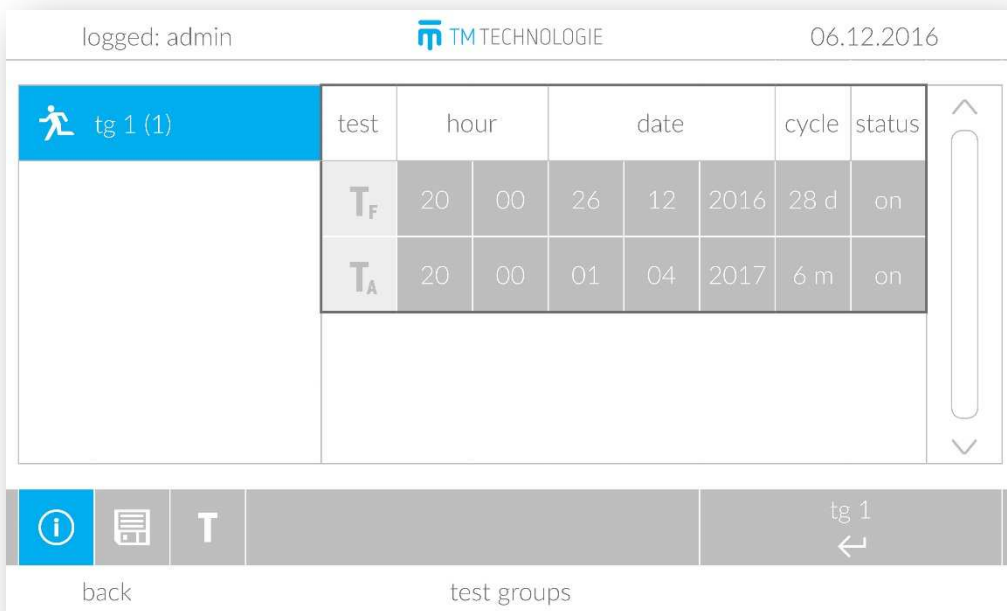

4.1 Test Groups



Each substation is automatically assigned to its test group. The group task is the automatic (cyclic) triggering of tests according to a preset schedule. After the test, it is automatically postponed to a new date corresponding to a preset cycle. The function test cycle can be set in the range from 1 to 28 days – and the autonomy test cycle – from 1 to 12 months.

The test start date can be freely modified, keeping in mind that the test date cannot be earlier than the current date. After modifying the group settings, confirm changes by pressing  on the toolbar.







If the selected group was not modified, the toolbar allows to:

-  rename the group,
-  read the test history,
-  enable manual test.

4.2 Night Groups

The system allows to add 64 night groups to control the lighting. Each group can be configured to operate with three timers (timer mode) or with two I/O module inputs (dimming mode).

If the selected group was not modified, the toolbar allows to

-  rename the group,
-  add a new group,
-  remove the selected group,
-  add multiple circuits to the selected test group,
-  configure the group in the timer mode,
-  configure the group in the dimming mode,
- read the current state of the group operation.

Each action must be confirmed by pressing the “enter” icon.

4.2.1 Timer Mode

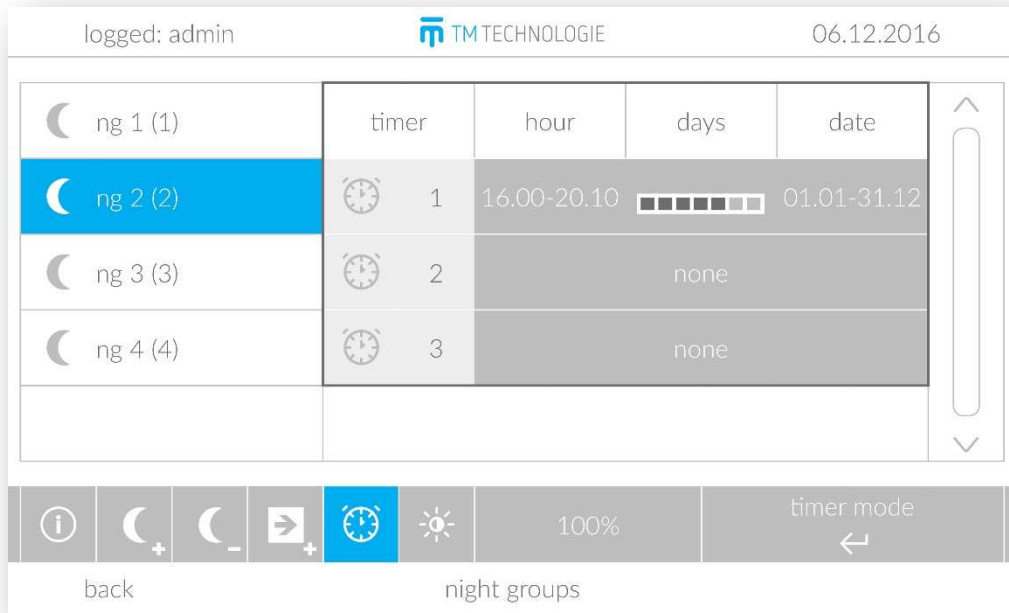

Timer mode allows to switch on the fitting for the so-called “maintained” operation in specified time. Each group can be configured to operate with up to three timers. Each timer has the option to set the time and date range and days of the week on which it will be active. If at least one timer satisfies the timing (i.e. is activated), then the group is activated and switches on the circuit for maintained operation. Timers should not overlap. After modifying the group settings, confirm changes by pressing  on the toolbar.

The timer can be chosen by selecting one of the three configuration fields and viewing available timers using arrows on the toolbar. The timer can be quickly removed by selecting the “cross” icon on the toolbar. In both cases, the selection must be confirmed by pressing the “enter” icon.

After modifying the group settings, confirm changes by pressing  on the toolbar.

4.2.2 Dimming Mode



Dimming mode is the operating mode of the night group which allows the fitting to operate with a preset dimming. In response to a change of the I/O module input state, the fitting enters operation mode according to the configured, so-called group truth table.

The user configures the group by setting the module number, input pin number and response to the input state. In addition, the user must configure the dimming percentage as a response to the state of a preset input. “dimm1” has higher priority than “dimm2”, which means that when the inputs of both configured modules are active, then the “on” dimming percentage will be applied for “dimm1”. Dimming can be set in the range from 0% to 100% with 10% increments. The system does not check whether the configured module is connected to the system and if it is an input module for sure.

After modifying the group settings, confirm changes by pressing  on the toolbar.

4.3 Adding Multiple Circuits to Groups

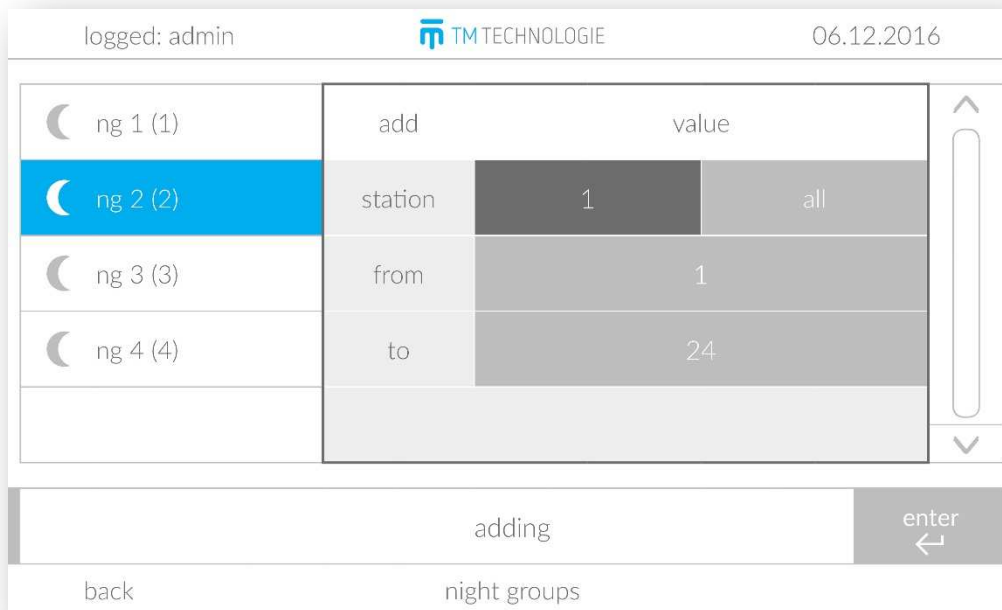

Night groups allow to add multiple circuits to one group at the same time. For this purpose, the user must select the desired group and then, on the toolbar, select the option of adding circuits to the group and confirm by pressing “**enter**”. The system takes the user to a window where it is possible to select:

- stations from which the circuits will be added (select a specific station or all stations),
- range of circuits to be added (1-24).

Adding must be confirmed by pressing “**enter**”.

All circuits satisfying the above objectives will be added to the selected group.

5. Tests



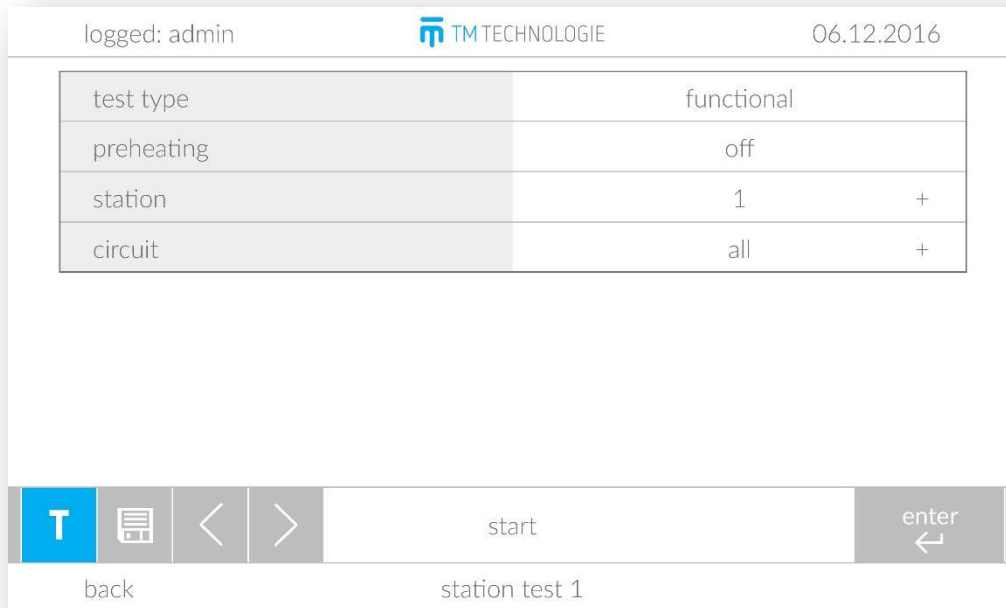

5.1 Manual Tests



The tab allows to start the station test. The user can start one of the following three tests:

- calibration test – this test involves the measurement of the circuit current which is then saved as a reference value. The user can turn on or off the preheating (for the set time, circuits operate with AC). The calibration should be performed for all circuits of the station at startup.
- function test – this test involves the measurement of the circuit current which is then compared with a reference value. The user can turn on or off the preheating. The test can be performed for the selected circuit or all circuits of the station,
- capacity test – this test lasts for 2/3 of the nominal substation operating time and checks the condition of batteries and fittings (by measuring the circuit current and/or reading the status of address modules). This test could be started only by service personnel and the user from level 2 "supervisor" (see section 7.1 Users).

The bottom bar allows to:

-   start or cancel the test,
-  view the test history,
-   trigger/view tests of other stations.

5.2 Test in Progress

test type	capacity
duration	120min
remained	121min
battery voltage	230,7V
battery current	0,0A

cancel

back station test 1 enter

If the station is currently tested, the window is changed to display parameters of the current test. The system displays information such as test type, its duration, the remaining time, as well as battery voltage and current.

5.3 Test History

test type	functional
finished	15:34 15.11.2016
test time	0/5min
last current/voltage	0,3A/227,5
test cancelled	yes
test cancel reason	code: 5
circuits error/tested	1/1
fittings error/tested	18/18

next test

back test result 2/59 station 1 enter



The user can browse the history of tests performed for the station. Tests are displayed from the latest to the oldest.

Once the test is performed, the following information is saved:

- test type,
- date of test completion,
- duration and nominal duration of the test,
- the last measured current and voltage of batteries,
- information whether the test was interrupted,
- cause of the test interruption,
- the number of tested circuits and the number of circuits with incorrect result,
- the number of tested fittings and the number of fittings with incorrect result,

The user can display the results of previous tests and navigate through them using arrows 



Enter the tested circuits  to display the list of tested circuits. If there are faulty fittings on any circuit,  is displayed next to the circuit name. Click on such a circuit to see a list with numbers of faulty fittings.



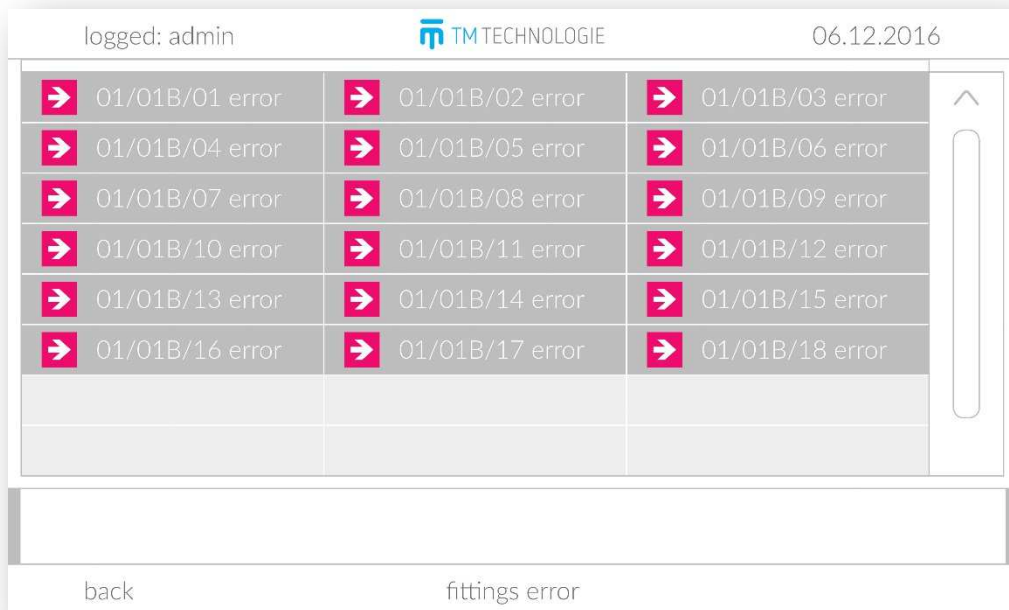

6. Organizer

After selecting the organizer indicator, the user can go to the following modules:

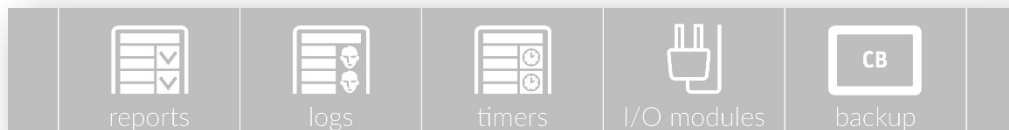

- **reports** – a list of reports on the system status,
- **logs** – information about all events in the system,
- **timers** – configuration of timers used to control the night lighting,
- **I/O modules** – a list of input/output modules,
- **backup** – settings of system backups.

6.1 Reports

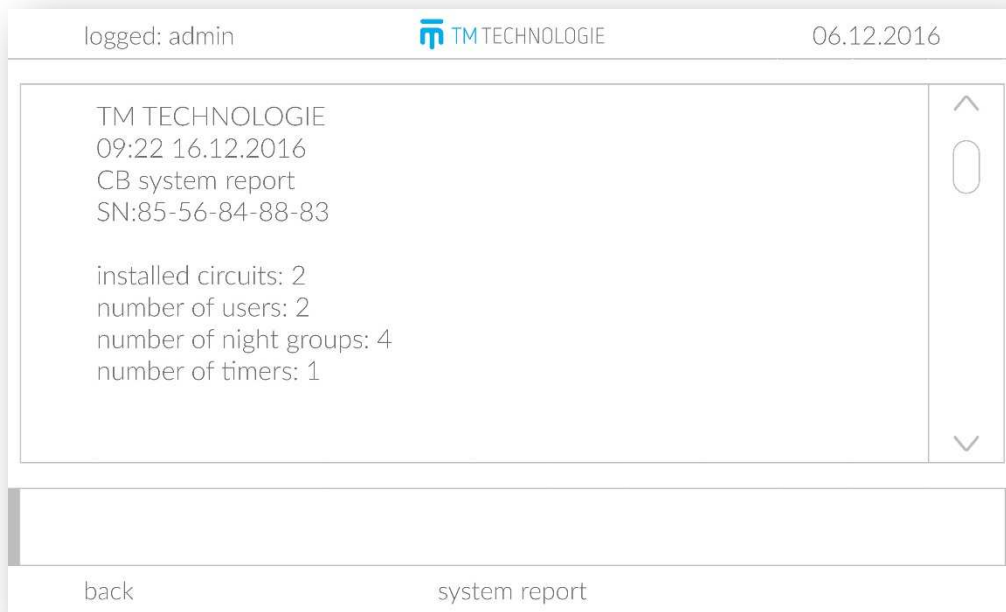

Reports are documents describing the system status and presenting the results of fitting tests in the system. Reports are generated monthly (at midnight of a new month) or on user request. Reports can be copied to a portable data carrier after its connection. Each report includes:

- date and time of the report,
- number of fittings installed in the system,
- number of users,
- number of night groups,
- number of timers,
- information about the stations added,
- information about circuits and fittings with errors.

At the service personnel request, a report can be saved, informing about the state of all circuits installed in the system.

After entering the report window, the system displays a list of reports to be browsed. Each report is described with a sequence of numbers **YYMMDDNN**, where:

YY – year of report generation (in 2-digit format),

MM – month of report generation (in 2-digit format),

DD – date of report generation (in 2-digit format).

NN – daily report number.

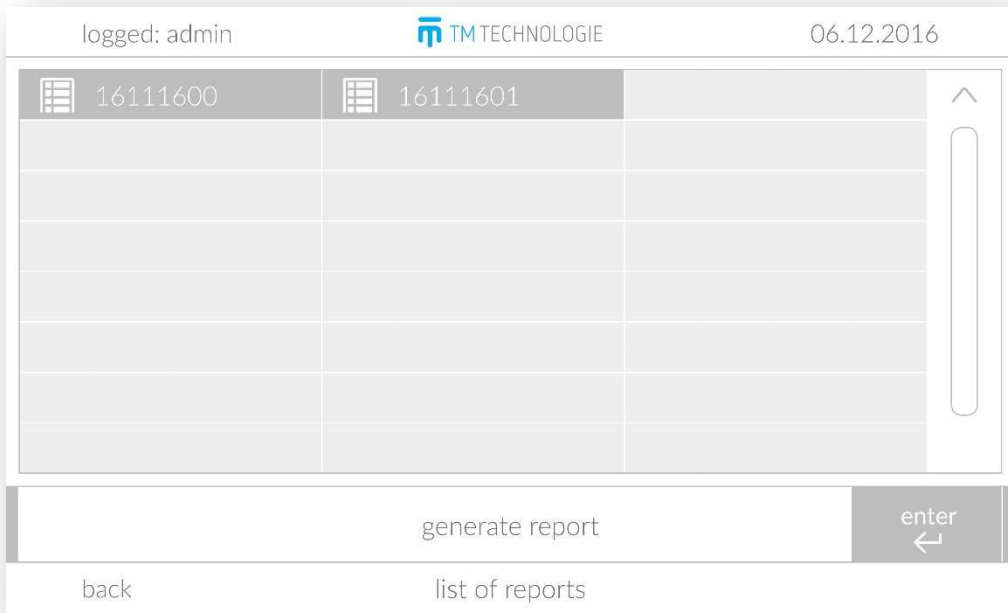

6.2 Logs

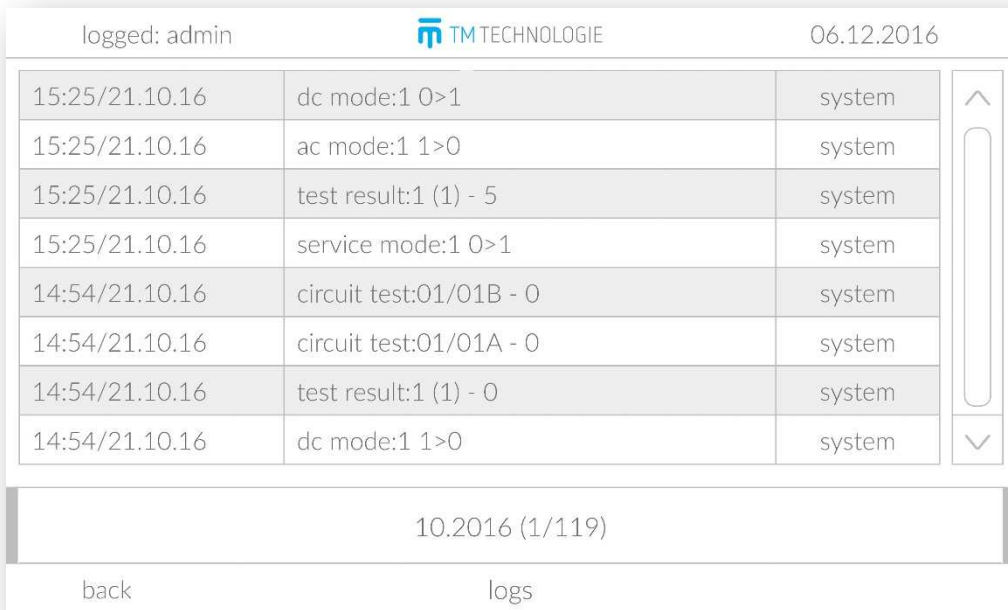

Logs are chronological records containing information about events and activities relating to the operation of TM-CB A system. Logs are created automatically by the system during operation. Logs can be copied to a portable data carrier after its connection. Some of the logs are visible only to the service personnel.

Each log on the list contains information about:

- date and time of the event,
- type and details of the event,
- user who triggered the event.

If the action was caused by the system, the triggering person is described as “system”.

The toolbar contains information about the month of logs which are currently browsed, the number of browsed log page, and the total number of pages of the browsed month.

After entering the log window, the system displays a list of logs to be browsed. Each list of logs is described with a sequence of numbers **MM.YYYY**, where:

- **YYYY** – year in 4-digit format,
- **MM** – month in 2-digit format.

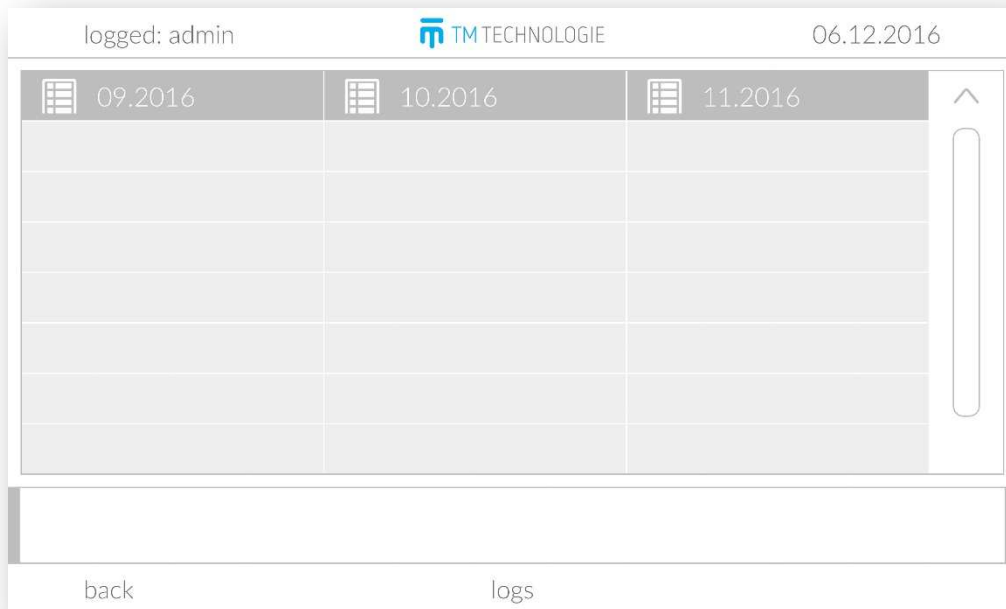

6.3 Timers

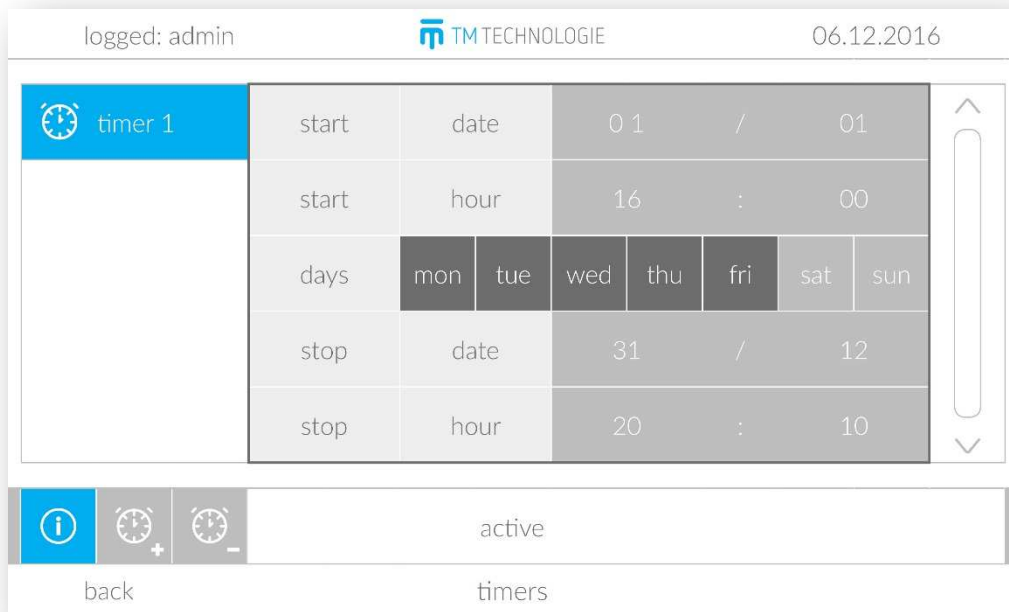



The system allows to add 64 independent timers. Timers are used to control the night groups. The following parameters can be set in each timer:

- date of activation,
- date of deactivation,
- hour of activation,
- hour of deactivation,
- day of the week on which the timer can be active.

After modifying the timer settings, confirm changes by pressing  on the toolbar.

If the selected timer was not modified, the toolbar allows to:







-  check the timer status,
-  add a new timer,
-  remove the selected timer.

Each action must be confirmed by pressing the “enter” icon.

6.4 I/O Modules

The TM-CB A system allows to connect 16 I/O modules. I/O modules can be of input or output type. Address of each module is set using DIP switches on the module housing. Addresses must be unique. After connecting the module, it must be searched for in order to be added to the system.

If the selected module was not modified, the toolbar allows to:

-  read and change the description of the module,
-  remove the selected module,
-  search for and add new modules,
-  configure error messages.
-  change of work mode – after the communication with the I/O module has disappeared, the system assumes active control signals from this module,
-  change of work mode – after the communication with the I/O module has disappeared, the system assumes no active control signals.

Each action must be confirmed by pressing the “enter” icon.

6.4.1 Input Module (IN SW, IN 24, IN 230)

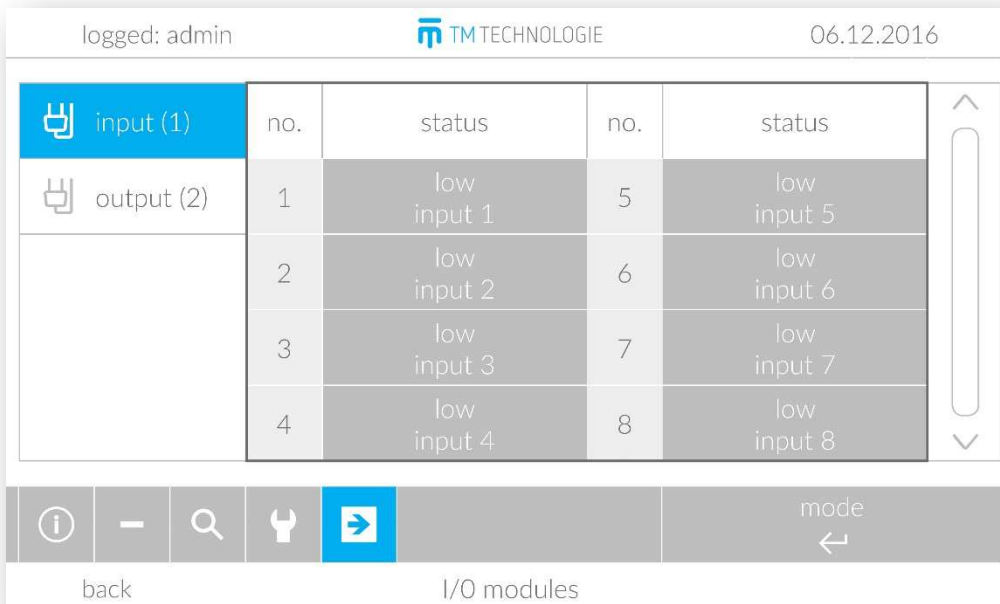

input (1)		no.	status	no.	status
output (2)		1	low input 1	5	low input 5
		2	low input 2	6	low input 6
		3	low input 3	7	low input 7
		4	low input 4	8	low input 8

logged: admin TM TECHNOLOGIE 06.12.2016

back I/O modules mode ←

Input module is a module used to control the system elements. It consists of eight inputs (control by closing or supplying voltage – depending on the model). In the input module window, the user can check the current status and description of all inputs.

The user can change description of a pin by clicking on the pin status.

6.4.2 Output Module (OUT)

input (1)	no.	status		no.	status	
output (2)	1	circuit err.	NO	5	unconf.	off
	2	station err.	NO	6	unconf.	off
	3	I/O error	NC	7	unconf.	off
	4	system err.	NC	8	unconf.	off

Output module is used to indicate the system status. Module outputs are opened and closed with a relay. The user configures each output by setting response to one of the five possible errors in the system:

- circuit error,
- station error,
- I/O module error,
- system error,
- no power supply.

The user can set whether the occurrence of errors should open (NO) or close (NC) the relay output.

After modifying the module settings, confirm changes by pressing  on the toolbar.

6.4.3 Error Messages

address	message	I/O module		
O1				
O2	error 01	1	1	on
O3	error 01	1	2	inv
O4	error 01	0	0	off
O5	error 01	0	0	off

error 01

enter ↵

back error messages

The control unit allows to display error messages in the main window of the system. It is possible to configure up to 64 error messages. The user can change the message text (up to 20 characters).

The yellow dot means:

- for the signal - active triggering,
- for the message - active message.

The user configures 4 inputs from external I/O modules; if one of them is triggered, it activates the error messages.

The first column is the address of I/O module, the second is the input (pin) number, and the third column determines the triggering method.

- on – active input (supply of voltage or closing),
- off – inactive input (no voltage or opening),
- inv – a response to a change in the previous state of the input.

6.5 Backup

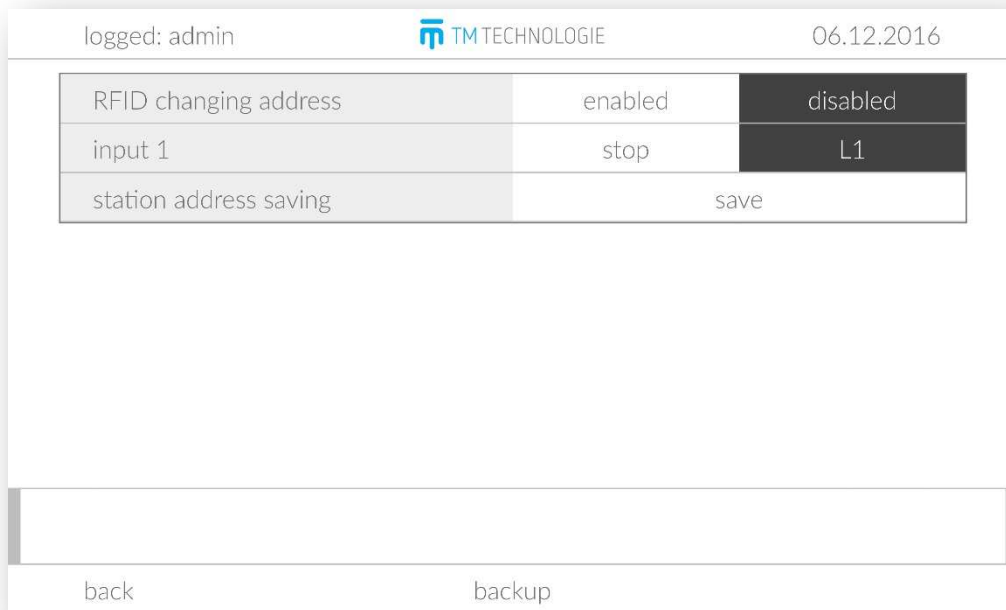

The tab allows to lock and prevent the fitting addresses from being changed through wireless programming. Once the option is changed, the systems sends a command to all fittings. Saving station address applies addresses set on the DIP switches. The user can choose whether the L1 input is to serve as a phase monitor or so-called Total Stop. If selected:

- L1 - L1 input acts as a phase monitor,
- Stop - Total Stop - L1 input is used for global disconnection of power supply to the entire station's circuits and connected substations, with one switch.

After logging in, the service personnel can use this tab to backup.

7. Settings

After selecting the settings indicator in the main window, the user can go to the configuration of the panel settings:



- users – accounts management,
- network – configuration of the Internet connection,
- panel – control unit settings,
- time – change of date and time,
- info – general information about the panel.

7.1 Users

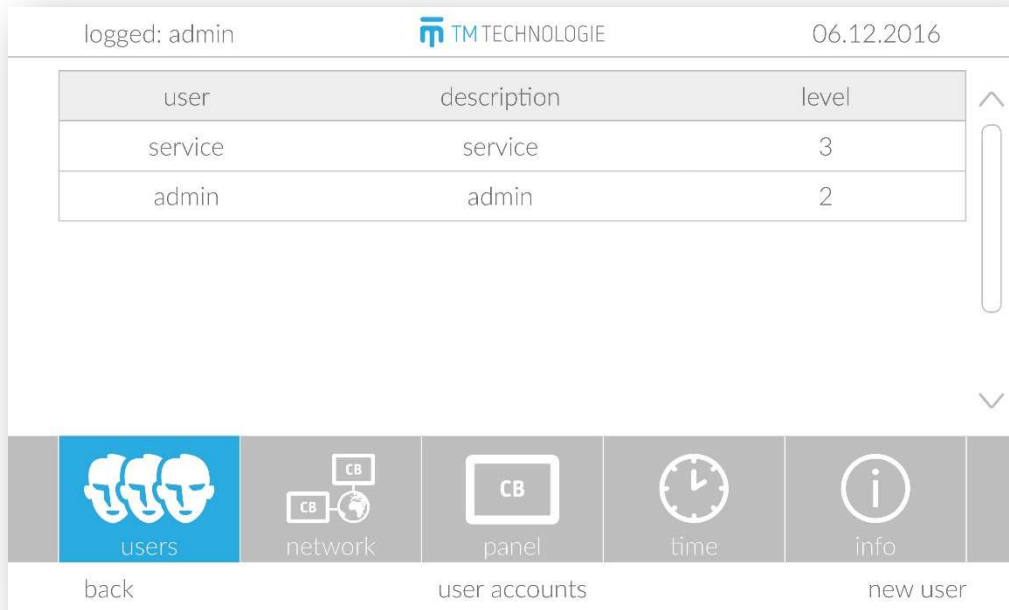

The menu contains a list of users added to the system. The system allows to add 250 users. The item on the list consists of the following elements:

- **user** – account name,
- **description** – up to 20-character description of the account used as a name extension,
- **level** – authorisation level of an account.

Each user is assigned an authorisation level. There are three authorisation levels:

- **level 1** – it is the lowest authorisation level, user at this level is able to configure the system (**basic user**),
- **level 2** – privileges are the same as in the case of the basic user, but the user is also able to create, deactivate and change passwords of basic user accounts (**supervisor**),
- **level 3** – the highest authorisation level (**service personnel**).

Each user account can be suspended by a user with higher authorisation level.

The user account can be viewed after selecting it on the list. Click on the “**add user**” field in the bottom right corner to add a new user. Once the user name and password are entered and confirmed, new user is added to the system. The account name and password must consist of at least four alphanumeric characters. Duplication of names is forbidden.

logged: admin TM TECHNOLOGIE 06.12.2016

user	admin
level	2

description	admin
password	*****
account	active

users

network

panel

time

info

back admin

After entering the account details, it is possible to:

- change the name (of the current account or of a user with lower authorisation level),
- change the password (of the current account or of a user with lower authorisation level),
- deactivation (of a user with lower authorisation level),

Instead of a number indicating the authorisation level, the symbol “-” (horizontal line) is displayed for the suspended user.

7.2 Network

logged: admin TM TECHNOLOGIE 06.12.2016

DHCP:

response:

IP:

mask:

gateway:

users

network

panel

time

info

back network connection

The “network” tab is used to configure the Internet connection between the panel and the user’s PC. The user can connect the unit directly to a PC or to a local network in the building. If connection to a PC is preferred, disable DHCP and configure the Internet connection by filling in the fields IP, mask, and gateway. If connection to a network automatically assigning an IP address is preferred, mark DHCP as “enabled”.

After a moment from connecting to the network, the panel should refresh the IP address, mask and gateway, showing the current configuration of the device. The gateway connection can be checked by pressing the “ping” button. In the answer field the device displays whether the connection was established or not. If an Internet connection was established, then, after entering the received IP address in the web browser, a website is displayed.

If CB control unit is installed in the network with MAC address filtering, be sure to add the MAC address of the control unit to the list of authorised devices in the network. The MAC address of the panel can be viewed in the “info” tab. In case of problems, please contact your local network administrator.

7.3 Panel

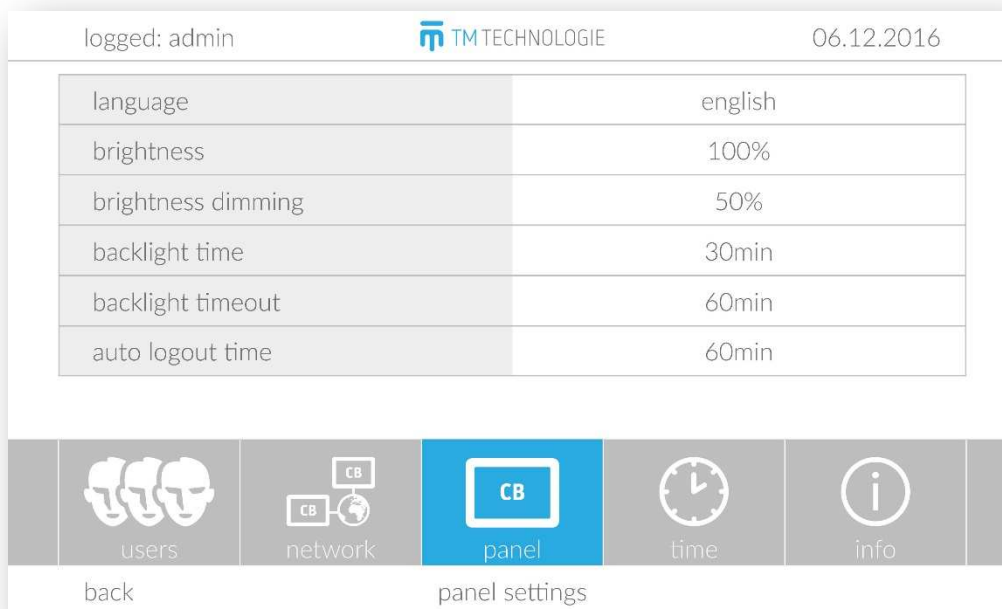

The tab is used to configure the panel settings. The user has the ability to change:

- **language** – menu language selection,
- **brightness** – percentage of panel illumination during operation (0-100%),
- **dimming brightness** – percentage of panel illumination after a period of inactivity, called the “backlight time” (0-50%),
- **backlight time** – duration of the period of inactivity after which the panel is dimmed (1-30 minutes),
- **timeout** – duration of the period of inactivity after which the panel is dimmed to its maximum (1-60 minutes) – the screen is not completely blanked,

- **auto logout** – duration of the period of inactivity after which the user is automatically logged out of the system, and panel goes to the main window (1-60 minutes).

If the “brightness” is lower than the “dimming brightness”, then, after the “backlight time”, the panel will remain illuminated according to settings of the “brightness”.

If the “timeout” is lower than the “backlight time”, then, after the period of inactivity equal to the “timeout”, the panel will be immediately and completely dimmed.

7.4 Time

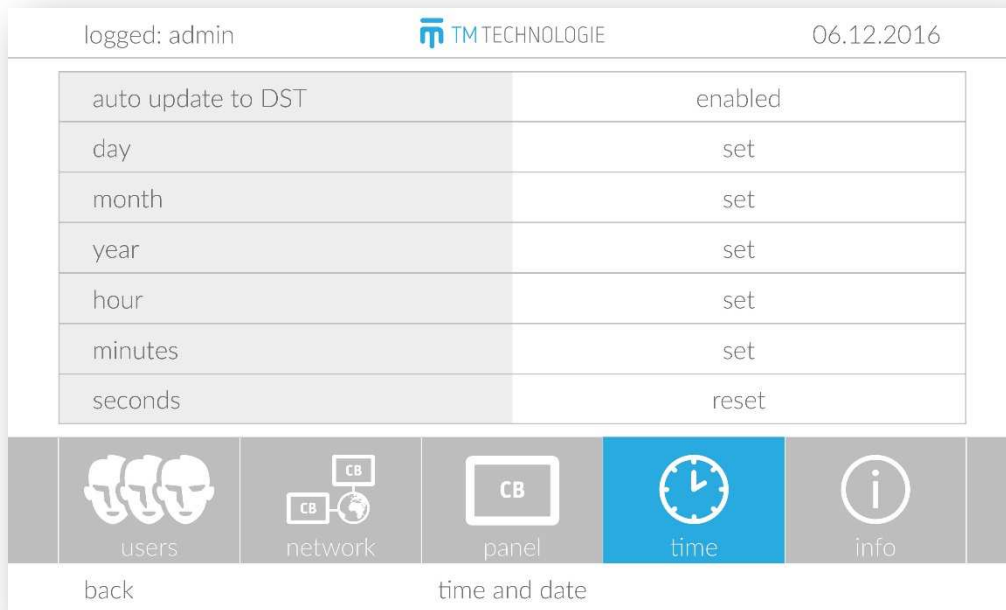

This window allows to correct the date and time. After being switched on by the user, the panel should display the correct date and time. If there was a clock desynchronisation, then the user must set the current time.





Note! TM Technologie is in no way liable for the consequences of improper setting of time by the user. Each change of date or time is stored in the logs of the user making the change.

The system allows to automatically switch between winter and summer time and back. With this option enabled, time change is made:

- at 2.00 a.m. local time on the last Sunday in March (change from winter to summer time),
- at 3.00 a.m. local time on the last Sunday in October (change from summer to winter time).

7.5 Information

logged: admin		TM TECHNOLOGIE		06.12.2016	
software	1.0.00	serial number	85-56-84-88-83		
hardware	2.0.00	MAC address	00:04:a3:c9:61:a6		
installation date	15.11.2016	bootloader code	21968		
service date	25.11.2017	manufacturer	show		
installed memory	15173 MB	service company	show		
available memory	15168 MB	object details	show		
memory in use	5 MB				

 users	 network	 panel	 time	 info
back		system information		

This tab presents basic information about the system:

- **software** – software version,
- **hardware** – panel hardware version,
- **installation date** – date of the system installation in the building,
- **service date** – date of the next maintenance services for the system,
- **installed memory** – informs about the capacity of the installed SD card,
- **available memory** – informs about the free space on SD card; contact the service centre, if there is less than 10 MB left,
- **memory in use** – informs about the amount of SD card memory used by the system,
- **serial number** – panel identification number,
- **MAC address** – physical address of the network interface of the panel,
- **bootloader code** – code generating the name of file used to update the system,
- **manufacturer** – information about producer,
- **service company** – information about service company,
- **object details** – information about the object on which control panel is installed.

8. Website

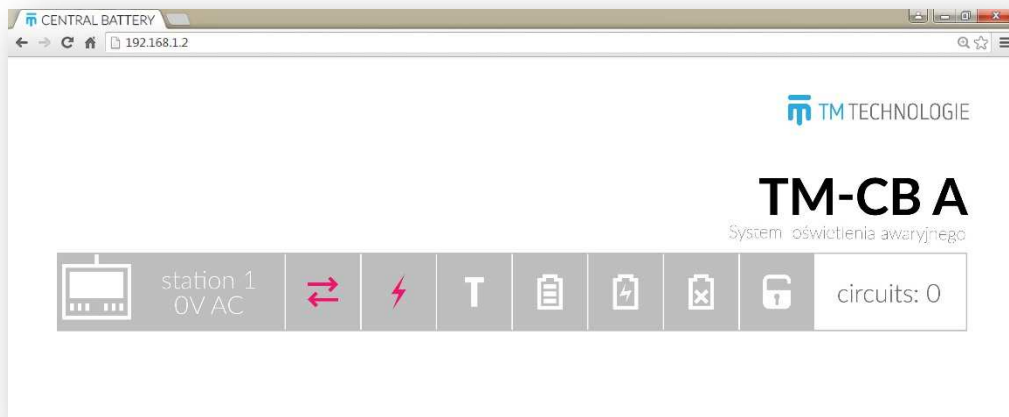

After successful configuration of the network connection and entering the set/received IP address in the web browser, a website should be displayed. The website allows to quickly preview the system status.

The website presents a list of substations added to the system and their status. Each line contains information on the state of:

- communication,
- power supply,
- test,
- battery,
- charger,
- deep discharge,
- service mode (disconnection of load),
- number of circuits on each substation.

Red icons indicate an error – diagnose and eliminate the cause of such error. Yellow icons indicate warning. White/green icons indicate that everything is okay.

9. USB devices

There are two USB ports on the front panel of the device. The right port allows to connect a USB keyboard, and the left port can be used to connect both a keyboard and a memory stick. Connection of a keyboard significantly speeds up typing of logins, passwords and names (of groups, fittings, substations, etc.). Once a memory stick is connected, the system displays a window to select actions which can be performed by the user (the user must be logged in).

The new window displays the following options:

- **rip reports and logs** – confirm to rip all reports and logs to a memory stick; the user can copy them to a PC or print them,
- **software update** – the system checks if the updated software is available on the memory stick; if so, the system starts to upload it to the memory and then, restarts,
- **touch screen calibration** – re-calibration of the touch screen,
- **cancel** – no action, return to the previous menu.

Note! USB flash drive must be formatted in the FAT32 file system

10. Important information

Important information concerning operation of the control panel is presented below:

- station work time must be set by the user,
- the system date and time must be carefully set so that all the scheduled automatic events are triggered in real time,
- remember to log out after completion of work with the panel; it aims to prevent unauthorised access to administrative functions,
- after a period of inactivity longer than the “auto logout” time (expressed in minutes), the user is automatically logged out and redirected to the home page window,
- USB flash drive must be formatted in the FAT32 file system,
- the user must set the operating time and capacity of the station batteries.

11. Modbus

11.1 *Introduction to Modbus communication*

All system information are available through Modbus TCP protocol. This is a Modbus variant used for communications over TCP/IP networks, connecting over port 502. IP address of central is in “network” tab in control panel settings. Input registers can be read using function 4 (Read Input Registers) of Modbus standard.

11.2 Modbus register map

Register address	Description	Data type	Value
0000	system error	unsigned	1 - error, 0 - ok
0001	stations error	unsigned	1 - error, 0 - ok
0002	circuits error	unsigned	1 - error, 0 - ok
0003	I/O modules error	unsigned	1 - error, 0 - ok
0004	status of station 1	structure	
0005	AC voltage station 1	unsigned	0...255 [V]
0006	DC voltage station 1	unsigned	0...255 [V]
0007	circuit number station 1	unsigned	0...24
0008	status of station 2	structure	
0009	AC voltage station 2	unsigned	0...255 [V]
0010	DC voltage station 2	unsigned	0...255 [V]
0011	circuit number station 2	unsigned	0...24
0012	status of station 3	structure	
...		structure	
0016	status of station 4	structure	
...		structure	
...		structure	
0252	status of station 63	structure	
...		structure	
0256	status of station 64	structure	
0260	status of circuit 01/01A	structure	
0261	status of circuit 01/01B	structure	
0262	status of circuit 01/02A	structure	
0263	status of circuit 01/02B	structure	
0264	status of circuit 01/03A	structure	
0265	status of circuit 01/03B	structure	
0266	status of circuit 01/04A	structure	
0267	status of circuit 01/04B	structure	
0268	status of circuit 01/05A	structure	
0269	status of circuit 01/05B	structure	
0270	status of circuit 01/06A	structure	
0271	status of circuit 01/06B	structure	
0272	status of circuit 01/07A	structure	
0273	status of circuit 01/07B	structure	
0274	status of circuit 01/08A	structure	
0275	status of circuit 01/08B	structure	
0276	status of circuit 01/09A	structure	
0277	status of circuit 01/09B	structure	
0278	status of circuit 01/10A	structure	
0279	status of circuit 01/10B	structure	
0280	status of circuit 01/11A	structure	
0281	status of circuit 01/11B	structure	

0282	status of circuit 01/12A	structure
0283	status of circuit 01/12B	structure
0284	status of circuit 02/01A	structure
0285	status of circuit 02/01B	structure
...		structure
0307	status of circuit 02/12B	structure
0308	status of circuit 03/01A	structure
...		structure
0331	status of circuit 03/12B	structure
0332	status of circuit 04/01A	structure
...		structure
0355	status of circuit 04/12B	structure
...		structure
...		structure
1771	status of circuit 63/12B	structure
1772	status of circuit 64/01A	structure
...		structure
1795	status of circuit 64/12B	structure

11.3 Station status

-	-	-	TE	CRIT	CHE	CIE	SM
bit 15							bit 8
DD	CHG	ERR	BAT	TEST	POW	COM	INS
bit 7							bit 0

- bit 15-13 **Unimplemented:** Read as '0'
- bit 12 **TE:** Station test error
1 = Error
0 = No error
- bit 11 **CRIT:** Critical circuit loop status
1 = Loop is open
0 = Ok
- bit 10 **CHE:** Charger error
1 = Error
0 = No error
- bit 9 **CIE:** Circuits error
1 = Error
0 = No error
- bit 8 **SM:** Service mode
1 = In service mode
0 = Normal mode

- bit 7 **DD:** Deep discharge
1 = Batteries after deep discharge
0 = No deep discharge
- bit 6 **CHG:** Charging
1 = Charging in progress
0 = No charging
- bit 5 **ERR:** Station error
1 = Error
0 = No error
- bit 4 **BAT:** Battery mode
1 = Battery mode
0 = Normal operation
- bit 3 **TEST:** Station test
1 = In test
0 = No test
- bit 2 **POW:** Power supply status
1 = Basic power supply
0 = No basic power supply
- bit 1 **COM:** Communication status
1 = Communication ok
0 = No communication
- bit 0 **INS:** Station installed
1 = Station installed
0 = No station

11.4 Circuit status

IO1	IO0	FE	FIT4	FIT3	FIT2	FIT1	FIT0
bit 15							bit 8
CUR	TEST1	TEST0	ST	MODE1	MODE0	COM	INS
bit 7							bit 0

- bit 15-14 **IO<1:0>:** Circuit configuration for external triggering
3 = Configured - circuit in a modified mode
2 = Configured - circuit off
1 = Configured - circuit in default mode
0 = Unconfigured
- bit 13 **FE:** Faulty fittings
1 = Faulty fittings
0 = Fittings ok
- bit 12-8 **FIT<4:0>:** Number of fittings
X = Number of fittings
0 = No fittings

- bit 7 **CUR:** Result of current measurement in the last test
 1 = Error
 0 = No error
- bit 6-5 **TEST<1:0>:** Test status
 3 = Reserved
 2 = Test error
 1 = In test
 0 = Test ok
- bit 4 **ST:** Circuit card state
 1 = Error
 0 = No error
- bit 3-2 **MODE<1:0>:** Default operating mode of circuit
 3 = Non-maintained operation
 2 = Maintained operation
 1 = Disabled
 0 = Unconfigured
- bit 1 **COM:** Communication status
 1 = Communication ok
 0 = No communication
- bit 0 **INS:** Circuit card installed
 1 = Card installed
 0 = No card

TM TECHNOLOGIE Sp. z o.o.

32-084 Morawica

Morawica 355, near Krakow

tel.: +48 12 444 60 60

fax: +48 12 350 57 34

www.tmtechnologie.pl

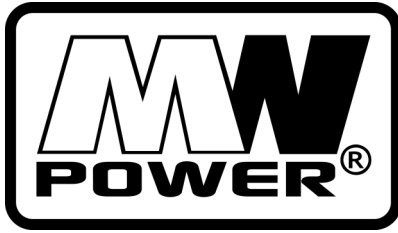

MWP 5-12L

Accordance with standards

PN-EN 60896-21:2007
 PN-EN 60896-22:2007
 PN-EN 61056-1:2013-05
 PN-EN 61056-2:2013-05
 PN-E-83016:1999

MWP series MW Power batteries are made in VRLA (AGM) technology and they are dedicated to use in emergency power supply and also other different applications where battery works in cycle use. Preferred applications of this battery series: emergency power supply UPS, in automatic

systems, as energy source in mobile devices, power supply for motors and other different devices in cycle use mode. 600 work cycles for 50% discharge. 12 years designed lifetime at 20-25°C.

Specification		
Nominal voltage	12V	
Nominal capacity	5 Ah	
Dimensions	Length	90 mm
	Width	70 mm
	Height	101 mm
	Total height	107 mm
Weight	1,9 kg	



Dimensions mm (inches)

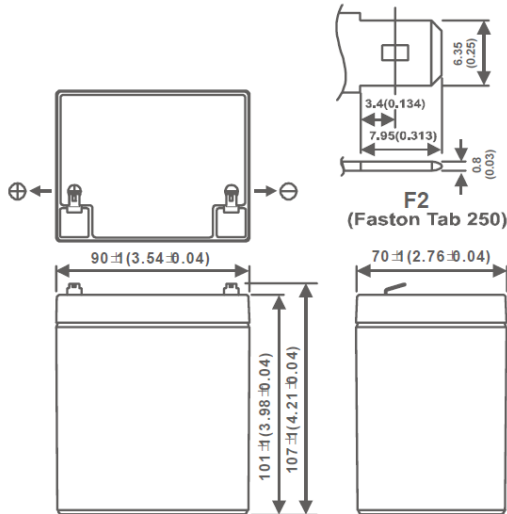

Discharge characteristic

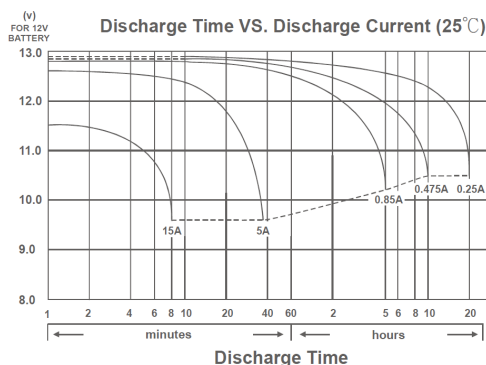

Characteristic		
Capacity at 25°C and cutoff voltage of 10,2V	20h	5,50 Ah
	10h	5,00 Ah
	5h	4,50 Ah
Internal resistance	Battery fully charged	19 mΩ
Capacity	At 20°C	100%
	At 0°C	85%
	At -15°C	65%
Self-discharge	3 months	90%
	6 months	80%
	12 months	65%
Connector/Case	F18 / ABS UL94 HB	
Charging	Buffer	13,5-13,8 V
	Cyclic	14,4-15,0 V
Max charge current	1,5 A	
Max discharge current	75A / 5s	
Working temperature	Discharge	-20°C—50°C
	Charge	-20°C—50°C
	Storage	-20°C—50°C



SALES OFFICE:
 03-310 WARSZAWA
 UL. STANIEWICKA 14
 TEL. 32 44 00 960
 FAX: 22 674 75 21,
 E-MAIL: HANDEL@MPLENERGY.PL

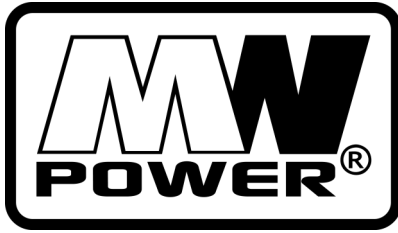

MWP 5-12L

Accordance with standards

- PN-EN 60896-21:2007
- PN-EN 60896-22:2007
- PN-EN 61056-1:2013-05
- PN-EN 61056-2:2013-05
- PN-E-83016:1999

Temperature impact on battery capacity

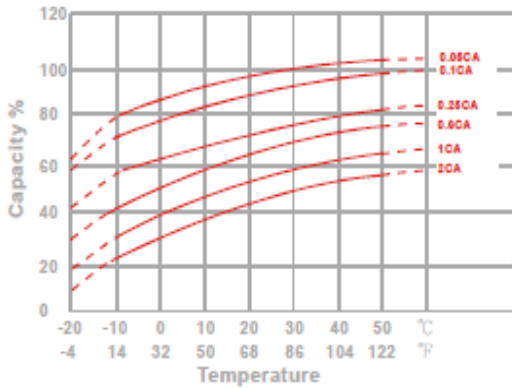

Characteristic of capacity drop during storage

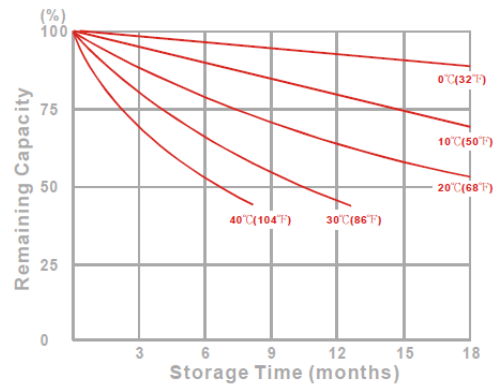

Battery lifetime for buffer use mode

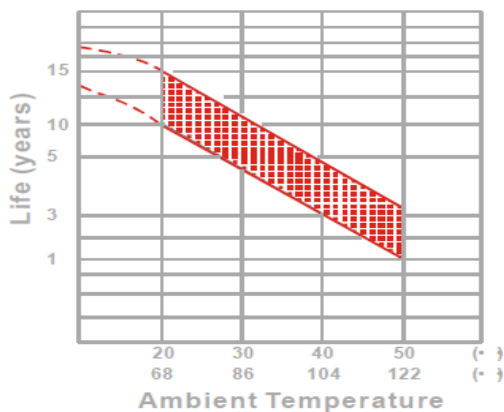

Constant power discharge characteristic (Watt, 25°C)

Voltage	11,1 V	10,8 V	10,5 V	10,2 V	9,9 V	9,6V
5 min	237	249	261	266	273	282
10 min	166	175	181	184	188	194
15 min	127	131	135	137	139	142
30 min	70,3	72,7	75,1	75,9	76,8	77,5
60 min	37,6	38,8	40,2	40,9	41,6	42,4
120 min	20,3	21,2	21,9	22,3	22,8	23,5
180 min	16,3	17,1	17,8	18,1	18,4	18,9
240 min	12,9	13,6	14	14,2	14,4	14,7
300 min	11,2	11,7	11,9	12	12,1	12,3
600 min	6,53	6,89	7,02	7,08	7,14	7,23
1200 min	3,43	3,62	3,69	3,72	3,75	3,8

Battery lifetime for cycle use mode

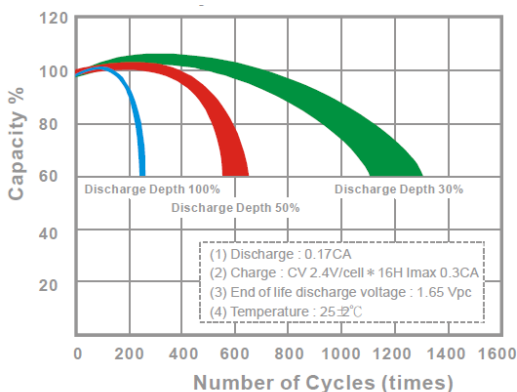

Constant current discharge characteristic (A, 25°C)

Voltage	11,1 V	10,8 V	10,5 V	10,2 V	9,9 V	9,6V
5 min	21,7	23,9	25,8	26,4	27	27,8
10 min	14,8	15,7	16,2	16,6	16,9	17,3
15 min	10,5	10,9	11,1	11,2	11,3	11,5
30 min	6,15	6,26	6,38	6,42	6,47	6,55
60 min	3,2	3,38	3,46	3,49	3,53	3,59
120 min	1,7	1,79	1,87	1,91	1,94	1,99
180 min	1,35	1,41	1,47	1,49	1,52	1,55
240 min	1,07	1,11	1,15	1,16	1,18	1,21
300 min	0,898	0,919	0,942	0,953	0,962	0,978
600 min	0,506	0,514	0,521	0,524	0,529	0,535
1200 min	0,274	0,279	0,284	0,286	0,287	0,291



SALES OFFICE:
 03-310 WARSZAWA
 UL. STANIEWICKA 14
 TEL. 32 44 00 960
 FAX: 22 674 75 21,
 E-MAIL: HANDEL@MPLENERGY.PL



MW 7,2-12/MW 7,2-12L

12V 7,2Ah

Compliance with standards

EN 60896-21:2007
 EN 60896-22:2007
 EN 61056-1:2008
 EN61056-2:2003(U)
 E-83016:1999

Batteries **MW Power** type **MW** are designed for use both in emergency power supply systems and other applications where the battery operates cyclically. Recommended use of the batteries: UPS backup power supply, automation systems, cash registers, as a source of energy in portable devices, charging power engines and other equipment in a cyclic mode. For discharges of 50% can reach 500 cycles.

Designed service life 6-9 years to range of 20-25 ° C.



Specification

Nominal voltage	12V	
Capacity	7,2 Ah	
Dimensions	Length	151 mm
	Width	65 mm
	Height	94 mm
	Total height	100 mm
Weight	2,45 kg	

Dimensions

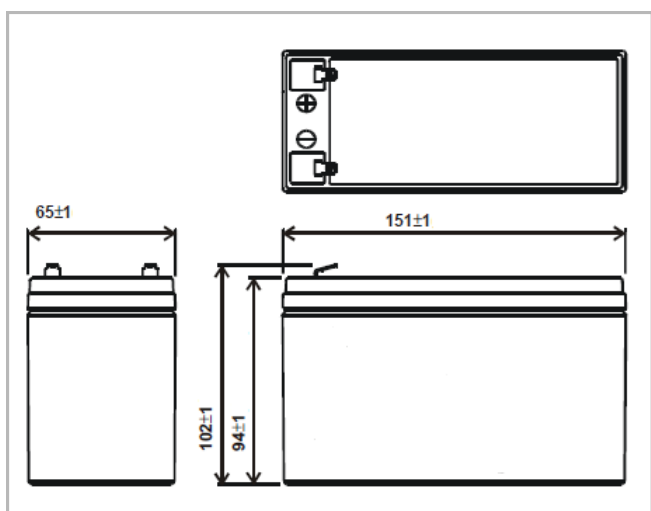

Characteristics

Capacity for 25 ° C and cut-off voltage 10.5 V	20h	7,2 Ah
	10h	6,85 Ah
	5h	6,15Ah
Internal resistance	charged battery	22 mΩ
Capacity	for 20°C	100%
	for 0°C	85%
	for -15°C	65%
Self-discharge	3 m-ths	91%
	6 m-ths	82%
	12 m-ths	64%
Terminal	Fast-on 187 (T1)/MW 7,2-12 Fast-on 250 (T2)/MW 7,2-12L	
Charging	Stanby use	13,5-13,80V
	Cyclic use	14,40-15,00V
Max. charge current	2,25 A	
Max. discharge current	100 A (5 sec.)	
Temperatures of work:		
Charging: -20°C ÷ 50°C		
Discharging: -20°C ÷ 50°C		
Storage: -20°C ÷ 50°C		

Input-discharge at 25 ° C

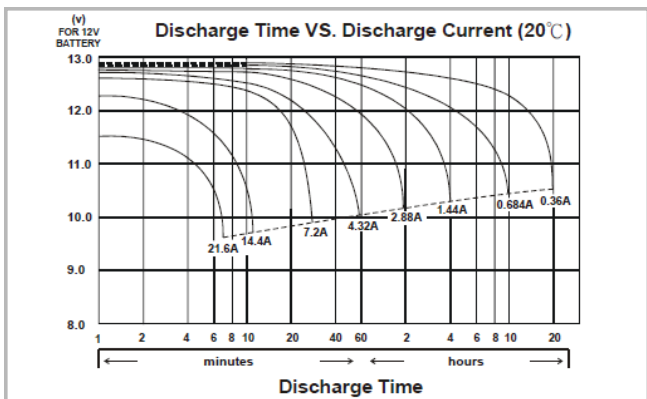

Terminal

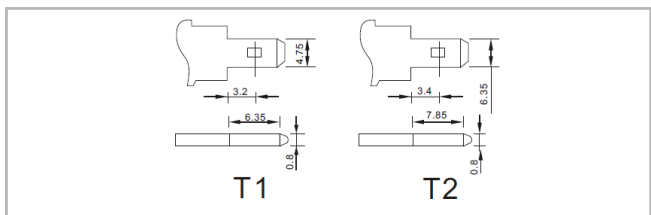

Uzupełnienie do instrukcji montażu Supplement to installation instructions

Instrukcja konfiguracji modułów adresowalnych do systemu TM-CB Configuration manual of addressable modules for TM-CB systems

1. Podłączenie zasilania do modułu / Power supply connection to module 2. Konfiguracja DIP-SW / Configuration DIP-SW

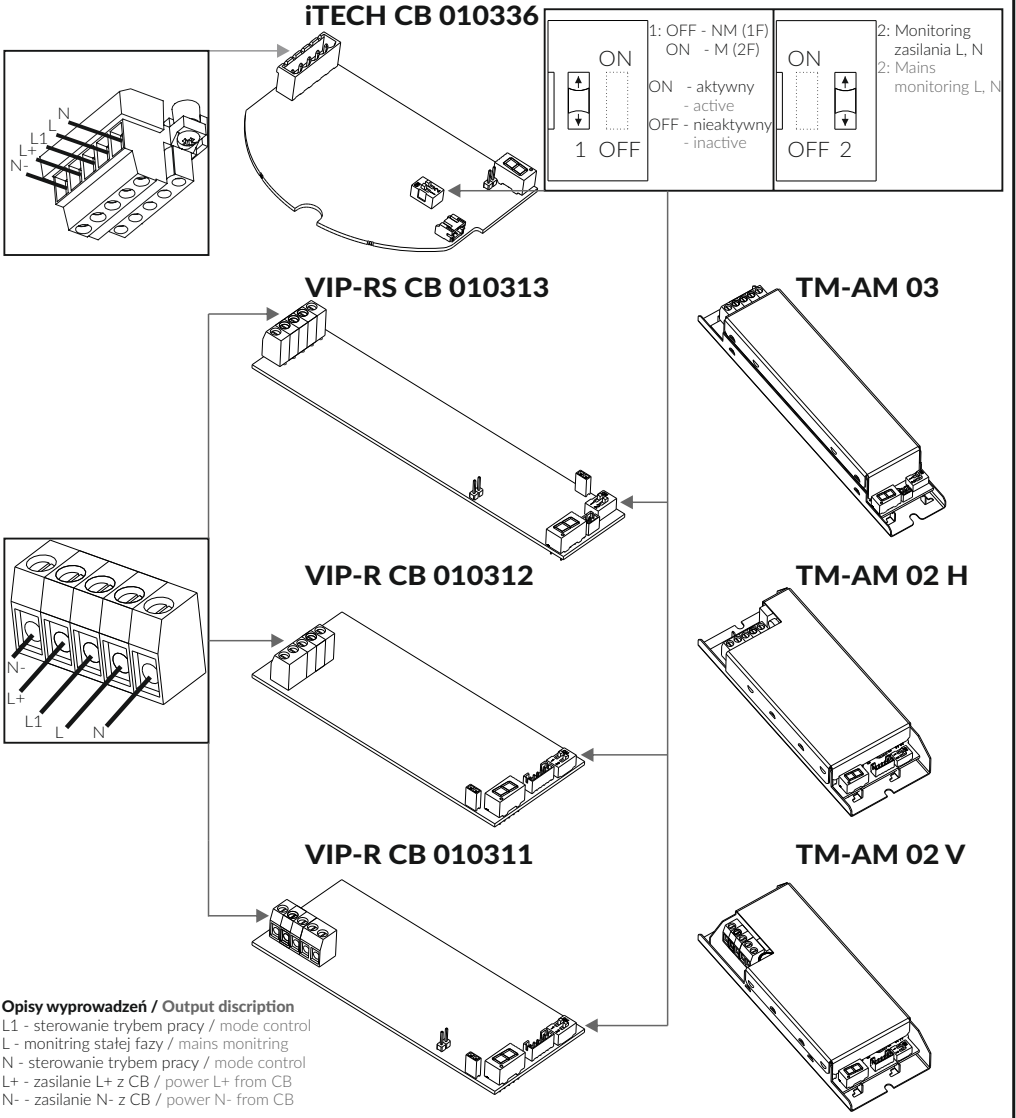

3. Tabela stanów / State table

Wejścia Input			DIP-SW		Wyjścia Output	Opis Description
L1 N	LN	L+ / N-	1	2	Zródło światła Light source	
X	X	DC	X	X	Załączone Turn on	Praca w trybie DC DC mode
AC	X	AC	OFF	OFF	Załączone Turn on	Praca w trybie AC sterowana L1 AC mode with L1 input control
Brak None	X	AC	OFF	OFF	Wyłączone Turn off	Praca w trybie AC sterowana L1 AC mode with L1 input control
X	X	AC	ON	OFF	Załączone Turn on	Praca w trybie AC na jasno (M) Maintained mode
X	AC	AC	ON	ON	Załączone Turn on	Praca w trybie AC na jasno (M), monitoring zasilania aktywny Maintained mode, mains monitoring active
X	Brak None	AC	X	ON	Załączone Turn on	Praca w trybie AC, monitoring zasilania aktywny AC mode, mains monitoring active
AC	AC	AC	OFF	ON	Załączone Turn on	Praca w trybie AC, sterowana L1, monitoring zasilania aktywny AC mode with L1 control, mains monitoring active
Brak None	AC	AC	OFF	ON	Wyłączone Turn off	Praca w trybie AC, sterowana L1, monitoring zasilania aktywny AC mode with L1 control, mains monitoring active
X	X	AC	X	X	Załączone Turn on	Tryb zmodyfikowany / tryb M (sterowanie z CB) Modified mode / M mode (control from CB)
X	X	AC	X	X	Wyłączone Turn off	Tryb NM (sterowanie z CB) NM mode (control from CB)

X - stan dowolny / any state Konfiguracja DIP-SW / Configuration DIP-SW ON - aktywny / active
 1: OFF - NM (1F) OFF - nieaktywny / inactive
 ON - M (2F)
 2: Monitoring zasilania L, N / Mains monitoring L, N

4. Sygnalizacja wyświetlacza / Signals display

Wyświetlacz sygnalizuje kolejno i cyklicznie / The display indicates the sequence and repeatedly

Sygnalizacja wyświetlacza Signals display	Opis Description	Sygnalizacja wyświetlacza Signals display	Opis Description
Rodzaj zasilania modułu Type of power supply module		Informacje o urządzeniu (tylko w trybie DC) Device information (only in DC mode)	
	zasilanie napięciem zmiennym AC voltage powered		prąd lub napięcie powyżej progu current or voltage above the threshold
	zasilanie napięciem stałym DC voltage powered		prąd lub napięcie w progu current or voltage in the threshold
Informacje o urządzeniu (tylko w trybie AC) Device information (only in AC mode)			prąd lub napięcie poniżej progu current or voltage below the threshold
	dipswitch 1 OFF, dipswitch 2 OFF		odwrócona polaryzacja zasilania L+/N- reversed polarity of power supply L+/N-
	dipswitch 1 OFF, dipswitch 2 ON	Adres Address	
	dipswitch 1 ON, dipswitch 2 ON		pierwsza cyfra adresu first digit of the address
	dipswitch 1 ON, dipswitch 2 OFF		oprawa niezaadresowana lub błąd urządzenia unaddressed fitting or device error
	źródło światła wyłączone (tryb NM) slight source off (NM mode)	Adres Address	
	źródło światła załączone (tryb M) slight source on (M mode)		druga cyfra adresu second digit of the address
	załączony tryb zmodyfikowany modified mode on		oprawa niezaadresowana lub błąd urządzenia unaddressed fitting or device error

5. Zmiana adresu / Address change

Adres na linii można zmienić za pomocą dedykowanego programatora RFID / Line address can be changed by using a dedicated RFID programmer

Opis / Description
 Moduł adresowalny służący do monitorowania stanu dowolnej oprawy oświetlenia o zakresie mocy 3-200W, współpracujący z systemem centralnej baterii z rodziny TM-CB. Moduł może być zaprogramowany do pracy na jasno, na ciemno lub według tabeli przedstawionej poniżej. Moduł zwróci błąd kiedy podczas testu obciążenie będzie pobierało mniejszą moc, niż zaprogramowany próg. Moduł umożliwiła bezprzewodową zmianę adresu za pomocą RFID.
Uwaga! Przy podłączeniu modułu do systemu TM-CB bardzo ważne jest zachowanie polaryzacji przewodów L+, N-. Podłączenie na odwrót spowoduje brak komunikacji z modułem. System CB komunikuje się z modułem po linii zasilającej. Nie można dublować adresów na obwodzie, adresy nie muszą być po kolei.
 The addressable module is used to monitor the status of any lighting luminaire with a power consumption of less than 200W. The module can be programmed to maintained-mode, non-maintained mode or at the table below. The module enables RFID address change.
Attention! When connecting module to the TM-CBS controller circuit is very important to keep L+, N- cable polarity. Connecting the other way around will result in no communication with the module. The module returns an error when the load during the test they will need less than set threshold power. TM-CBS communicates with addressable module on the power line. You can not duplicate addresses on the one circuit, addresses do not have to be in one by one.





Dane techniczne / Technical parameters	
Parametry zasilania Power supply	210V-250 AC / 50Hz 186-254V DC
Natężenie prądu zasilania Supply currents	
Bez obciążenia Without load	7-9mA (DC) 20-24mA (NM-AC) 25-29mA (M-AC)
Maksymalne obciążenie With maximum load	794-1085mA (DC) 800-970mA (AC)
Nominalna moc (P) pobierana z sieci bez obciążenia Nominal power input without load	<1.9W (DC) <2.0W (NM-AC) <2.4W (M-AC)
Typ obsługiwanych opraw Types of supported luminaires	LED, fluoescencyjne, halogeny LED, fluorescent, halogens
Moc obciążenia Load power	3-200W
Zakres adresów Address range	1-20
Stopień szczelności Degree of protection	IP20
Klasa izolacji Isolation class	I
Zakres temperatury pracy Temperature range	t _a = -15°± 55°C
Materiał obudowy Housing material	Stal ocynkowana Galvanized steel
Maksymalna długość przewodów Maximum cord length	1 m

Dane do zamówień / Ordering data				
Model Model	Tryb pracy Mode	Moc Power	Próg Threshold	Wymiary Dimensions
TM-AM 01	M/NM	8-200 W	5W	145x32x23mm
TM-AM 01S	M/NM	3-50 W	2W	145x32x23mm

Montaż / Assembly
 W przypadku montażu modułów w oprawach o I klasie izolacji należy zawsze podłączyć przewód ochronny PE do oprawy. Nie podłączenie przewodu ochronnego PE jest rażącym naruszeniem zasad bezpieczeństwa, może skutkować niepoprawną pracą modułu i oprawy jak również doprowadzić do uszkodzenia modułu lub/i statecznika.
 During the assembly of an module of the fittings in the first class of insulation always connect the protective conductor PE. Do not connect the PE conductors is a gross violation of safety rules. May result in incorrect operation of the module as well as cause damage to the unit or electronic ballast.

Instrukcja modułu adresowalnego TM-AM 01

Manual of addressable module TM-AM 01

IP 20  210 ± 250 V AC
50 Hz
186 ± 254 V DC   

Podłączenie zasilania i konfiguracja
Power supply connection and configuration

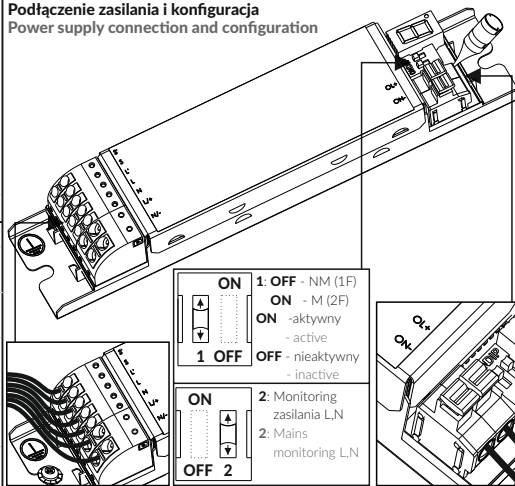

Schemat podłączenia / Schematic diagram

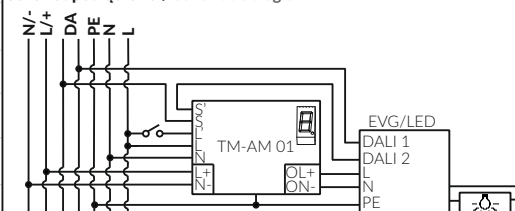

Opisy wyprowadzeń / Output discription

- S⁻ - styki bezpotencjałowe do odłączenia napięcia sterującego ściemnianiem 2A, 120VAC, 24VDC / potential free contacts to disconnect the control voltage dimming
- S - styki bezpotencjałowe do odłączenia napięcia sterującego ściemnianiem 2A, 120VAC, 24VDC / potential free contacts to disconnect the control voltage dimming
- L⁻ - sterowanie trybem pracy / mode control
- L - monitoring stałej fazy / mains monitoring
- N - sterowanie trybem pracy / mode control
- L+ - zasilanie L/+ z systemu CB / power L/+ from CB
- N- - zasilanie N/- z systemu CB / power N/- from CB
- OL+ - zasilanie L/+ oprawy awaryjnej / L/+ power emergency luminaire
- ON- - zasilanie N/- oprawy awaryjnej / N/- power emergency luminaire

Wykres / Graph



Tabela stanów / State table

Wejścia Input			DIP-SW		Wyjścia Output		Opis Description
L' N	LN	L+ / N-	1	2	OL+ / ON-	S S'	
X	X	DC	X	X	DC	Rozwarty Open	Praca w trybie DC DC mode
AC	X	AC	OFF	OFF	AC	Zwarty Short	Praca w trybie AC sterowana L' AC mode with L1 input control
Brak None	X	AC	OFF	OFF	Brak None	Zwarty Short	Praca w trybie AC sterowana L' AC mode with L1 input control
X	X	AC	ON	OFF	AC	Zwarty Short	Praca w trybie AC na jasno (M) Maintained mode
X	AC	AC	ON	ON	AC	Zwarty Short	Praca w trybie AC na jasno (M), monitoring zasilania aktywny Maintained mode, mains monitoring active
X	Brak None	AC	X	ON	AC	Rozwarty Open	Praca w trybie AC, monitoring zasilania aktywny AC mode, mains monitoring active
AC	AC	AC	OFF	ON	AC	Zwarty Short	Praca w trybie AC, sterowana L', monitoring zasilania aktywny AC mode with L' control, mains monitoring active
Brak None	AC	AC	OFF	ON	Brak None	Zwarty Short	Praca w trybie AC, sterowana L', monitoring zasilania aktywny AC mode with L' control, mains monitoring active
X	X	AC	OFF	X	AC	Rozwarty Open	Tryb zmodyfikowany / tryb M (sterowanie z CB) Modified mode / M mode (control from CB)
X	X	AC	OFF	X	Brak None	Rozwarty Open	Tryb NM (sterowanie z CB) NM mode (control from CB)

X - stan dowolny / any state Konfiguracja DIP-SW / Configuration DIP-SW ON - aktywny / active
 1: OFF - NM (1F) OFF - nieaktywny / inactive
 ON - M (2F)
 2: Monitoring zasilania L, N / Mains monitoring L, N

Sygnalizacja wyświetlacza / Signals display

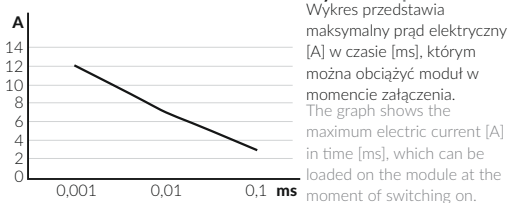
Wyświetlacz sygnalizuje kolejno i cyklicznie / The display indicates the sequence and repeatedly

Sygnalizacja wyświetlacza Signals display	Opis Description	Sygnalizacja wyświetlacza Signals display	Opis Description
Rodzaj zasilania modułu Type of power supply module		Informacje o urządzeniu (tylko w trybie DC) Device information (only in DC mode)	
	zasilanie napięciem zmiennym AC voltage powered		prąd lub napięcie powyżej progu current or voltage above the threshold
	zasilanie napięciem stałym DC voltage powered		prąd lub napięcie w progu current or voltage in the threshold
Informacje o urządzeniu (tylko w trybie AC) Device information (only in AC mode)			prąd lub napięcie poniżej progu current or voltage below the threshold
	dipswitch 1 OFF, dipswitch 2 OFF		odwrotna polaryzacja zasilania L+/N- reversed polarity of power supply L+/N-
	dipswitch 1 OFF, dipswitch 2 ON		Adres Address
	dipswitch 1 ON, dipswitch 2 ON		pierwsza cyfra adresu first digit of the address
	dipswitch 1 ON, dipswitch 2 OFF		oprawa niezadresowana lub błąd urządzenia unaddressed fitting or device error
	źródło światła wyłączone (tryb NM) light source off (NM mode)		Adres Address
	źródło światła załączone (tryb M) light source on (M mode)		druga cyfra adresu second digit of the address
	załączony tryb zmodyfikowany modified mode on		oprawa niezadresowana lub błąd urządzenia unaddressed fitting or device error

Zmiana adresu / Address change

Adres na linii można zmienić za pomocą dedykowanego programatora TM-PROG / Line address can be changed by using a dedicated TM-PROG programmer

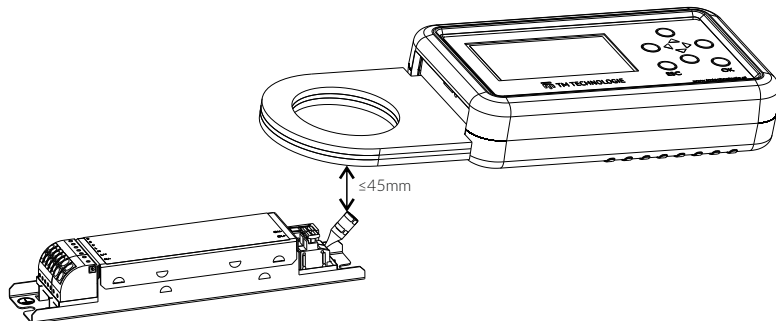

Instrukcja użytkownika - I.UIO.V1.1/11.05.2018

Uwagi bezpieczeństwa: **1.** Przeczytaj uważnie tę instrukcję. **2.** Należy zachować tę instrukcję w celu późniejszego wykorzystania. **3.** Urządzenie powinno być instalowane przez wykwalifikowany personel. **4.** Wszystkie połączenia elektryczne należy wykonywać przy wyłączonym zasilaniu. **5.** Należy chronić urządzenie przed wilgocią. **6.** Upuszczenie urządzenia może spowodować jego uszkodzenie. **7.** Przed podłączeniem urządzenia do zasilania upewnij się, że zasilanie jest odpowiednie. **8.** Ze względów bezpieczeństwa urządzenie powinno być otwierane tylko przez wykwalifikowany personel. **9.** Urządzenie przystosowane jest do użytku wewnątrz budynku. **10.** Zasilanie dla tego urządzenia musi spełniać wymagania dla Safety Extra Low Voltage (SELV) oraz Limited Power Source (LPS), zawartych w IEC 60950-1, 2nd.

Załącznik ilustrowany: **1.** Opis. **2.** Specyfikacja. **3.** Wymiary. **4.** Montaż. **4.1** Montaż urządzenia posiadającego uchwyt na szynę DIN. **4.2** Montaż zasilacza. **5.** Podłączenie. Podłączanie zasilania: do zasilacza podłączyć przewody zasilające L oraz N. L – przewód fazowy – kolor izolacji czarny lub brązowy; N – przewód neutralny – kolor izolacji niebieski; do zacisków POWER IN podłączyć przewody zasilające zwracając uwagę na biegunowość. Podłączenie przewodu PE: dla urządzeń o pierwszej klasie ochronności podłączyć przewód PE do zacisku na obudowie, PE-przewód ochronny – kolor izolacji zielono-żółty. TM-BUS: dla urządzeń posiadających magistralę TM-BUS podłączyć pary przewodów do kanałów A, B, C i D; polaryzacja nie jest ważna; zalecany przewód YTKSYekw 1x2x0,8 mm. RS-485: podłączyć pary przewodów do zacisków A i B portu RS-485 zgodnie z polaryzacją; na końcu magistrali RS-485 wymagany jest Terminator, zworka w pozycji T dołącza rezystor terminujący; zalecany przewód YTKSYekw 1x2x0,8 mm; adres ustawiać za pomocą przełącznika DIP SWITCH, wynikowy adres jest sumą wartości załączonych pozycji powiększoną o 1; **adres powinien być unikatowy!**; adres jest uaktualniany na bieżąco. IN1-8/K1-8: dla urządzeń posiadających wejścia IN lub wyjścia K podłączyć pary przewodów do zacisków. Polaryzacja nie jest ważna. Podłączane przewody dobrać odpowiednio do zastosowanych napięć. **6.** Sygnalizacja LED.

Uwagi końcowe: Czyszczenie można przeprowadzać miękką suchą szmatką, niedopuszczalne jest używanie agresywnych detergentów i rozpuszczalników. Ogólne warunki gwarancji znajdują się na stronie internetowej.

User Manual - I.UIO.V1.1/11.05.2018

Safety notes: **1.** Read this instruction carefully. **2.** Keep this manual for later use. **3.** The device should be installed by qualified personnel. **4.** All electrical connections should be made when the power is turned off. **5.** Protect the device from moisture. **6.** Dropping the device may damage it. **7.** Before connecting the device to a power source, make sure that the power supply is suitable. **8.** For safety reasons, the device should only be opened by qualified personnel. **9.** The device is adapted for use inside the building. **10.** The power supply for this device must meet the requirements for Safety Extra Low Voltage (SELV) and Limited Power Source (LPS), contained in IEC 60950-1, 2nd.

Illustrated attachment: **1.** Description. **2.** Specification. **3.** Dimensions. **4.** Assembly. **4.1** Installation of the device with a DIN rail holder. **4.2** Installation of the power supply. **5.** Connection. Connecting the power supply: connect the L and N power cords to the power supply. L - phase wire - black or brown insulation color; N - neutral wire - blue insulation color; connect the power cords to the POWER IN terminals paying attention to the polarity. Connecting the PE wire: for devices with first class protection, connect the PE wire to the terminal on the housing, PE - protective conductor - green-yellow insulation color. TM-BUS: for devices with TM-BUS bus, connect wire pairs to channels A, B, C and D; polarity is not important; the recommended YTKSYekw 1x2x0.8 mm cable. connect the wire pairs to terminals A and B of the RS-485 port in accordance with the polarity; Terminator is required at the end of the RS-485 bus, the jumper in position T attaches the terminating resistor; the recommended YTKSYekw 1x2x0.8 mm cable; set the address using the DIP SWITCH switch, the resulting address is the sum of the values of attached items plus 1; **the address should be unique!**; the address is updated on a regular basis. IN1-8/K1-8: for devices with IN inputs or K outputs connect the lead wires to the terminals. Polarization is not important. Connect the cables according to the applied voltages. **6.** LED signaling.

Final remarks: For cleaning, use dry soft cloth. Using aggressive detergents and solvents is forbidden. For the general warranty terms and conditions, please refer to the company's website.

TM-I/O



1

- 1. TM-I/O
- 2. DR-15-12, 12 V 15 W
- 3. CCA 2x0,75 mm

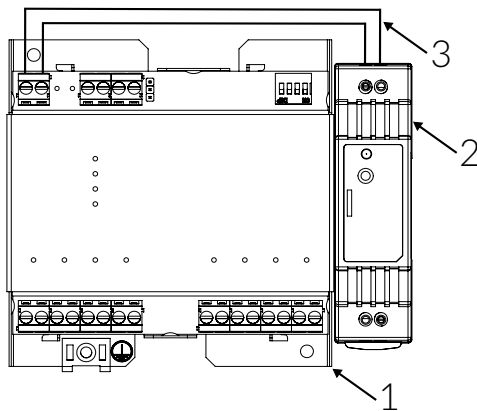

2

Model	Power IN	P _{max}	I _{max}	IN1-8 U _{max}	K1-8 U _{max}	K1-8 I _{max}	I, II, III
OUT	12 V DC ±10%	2,4 W	170 mA	-	400 V AC / 250 V DC	6 A	⊕
IN SW	12 V DC ±10%	1,2 W	100 mA	-	-	-	⊕
IN 24	12 V DC ±10%	1,2 W	100 mA	30 V DC	-	-	⊕
IN 230	12 V DC ±10%	1,2 W	100 mA	250 V AC	-	-	⊕

3

		L x W x H [mm]
1	TM-I/O	106 x 110 x 48
2	DR-15-12	25 x 95 x 56

4.1

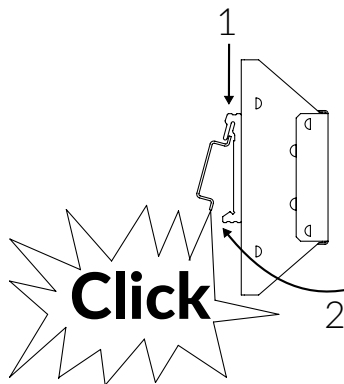

4.2

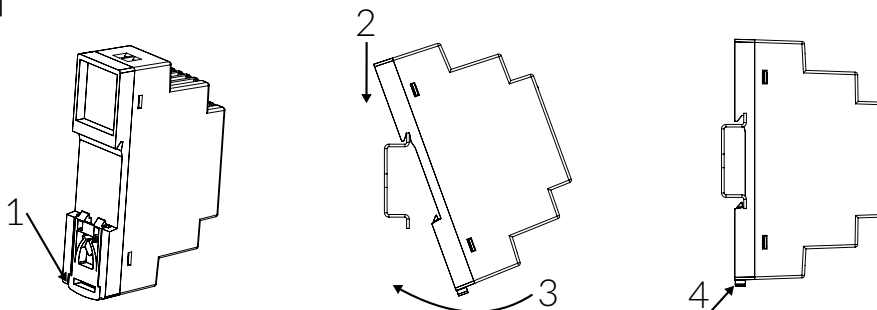

5

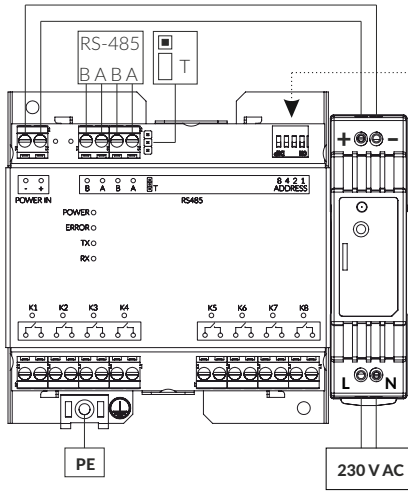
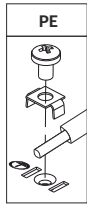

OUT

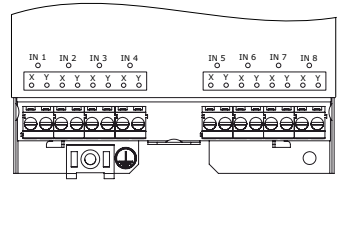
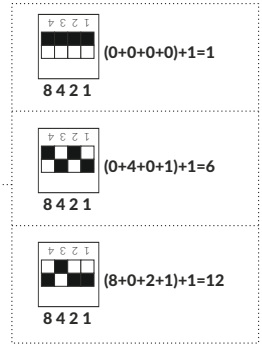

IN

6

Model	K 1-8	IN 1-8	LED
TM-I/O		-	0
IN SW			1
IN 24	-		0
	-		1
IN 230	-	U _{IN} : 0-1,15 V DC	0
	-	U _{IN} : 20-30 V DC	1
	-	U _{IN} : 0-138 V AC	0
	-	U _{IN} : 168-250 V AC	1

LED ON (1)	
POWER	POWER IN 12 V
ERROR	RS-485
TX	
RX	