

Sounder EV 21 Voice

Compact sounder for universal indoor and outdoor applications



Features

- Micro SD memory card min. 4 GB
- With over 80 pre-installed tones
- Volume: approx. 105 dB(A)
- Suitable for AC and DC voltage
- Robust housing made of aluminium
- Emergency signal according to DIN 33404/3
- Loud voice output with excellent tone and sound quality

Overview

The EV21 is an electronic sounder suitable for indoor and outdoor applications. The sturdy design allows for use even under difficult environmental conditions.

Eight different signal tone compositions may be externally controlled through the stage inputs and are played back by the sounder in a settable volume. The compositions assigned to the stage inputs are saved on a micro SD card inserted into the device and can be edited by the user by use of a configurator tool which is part of the memory card's scope of delivery. The user may optionally add his own recordings to the over 80 preinstalled tones.

The EV 21 Voice Sounder is a compact unity comprising power supply, amplifier and loudspeaker. The bottom box is made of seawater-resistant cast aluminium coated with plastic. The loudspeaker consists of impact and cold-resistant plastic and is permanently mounted to the housing.

Specifications

Housing	Seawater-resistant aluminium
Colour	Light grey
Ingress protection	IP 54 according to IEC 60529
Protection class	I
Operating voltage	85-265 VAC/24 VDC
Power consumption	230 VAC 0,03 A/24 VDC 0,12 A
Cable glands	1x M20 x 1.5 for 6-13 mm lines (second cable gland may be retrofitted)
Connection terminals	Terminal capacity: 2.5 mm ² single-wire 1.5 mm ² fine-wire
Operating conditions	Indoors and outdoors
Operating position	Preferably horizontal with cable glands facing downward
Operating mode	Continuous operation
Volume	Max. 105 dB(A), 1 m distance, adjustable via potentiometer
Loudspeaker	Dynamic pressure chamber loudspeaker, impact-resistant ABS plastic, permanently mounted to the housing
Memory	Micro SD card, min. 4 GB
Supported sound file	WAV format, uncompressed sample data (PCM), Mono/stereo ≤ 16 Bit, 2400-50400 samples per second
Temperature range	
Operation	-25 °C to +60 °C
Storage	-30 °C to +70 °C
Weight	Approx. 1.5 kg

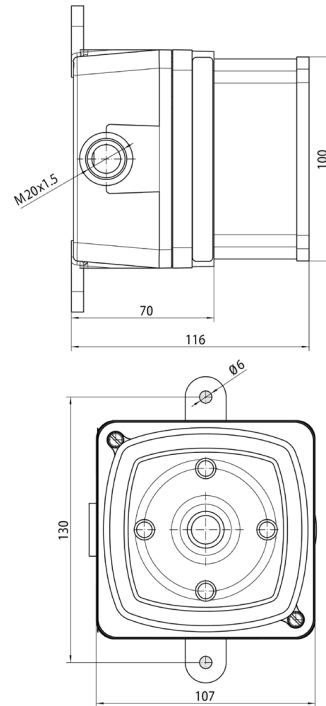

Pre-configured stages (0-7) by default

Stage 0

Siren sound 900 Hz

Stage 4

Alternating tone 544 Hz/440 Hz/2 Hz

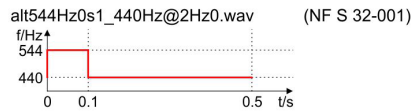

Stage 1

Emergency signal according to DIN 33404/EN457 T3

Falling tone 1200/500 Hz/1 Hz

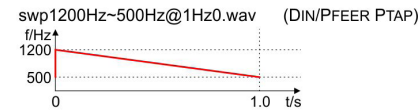

Stage 5

Intermittent 1000 Hz at 0.5 Hz

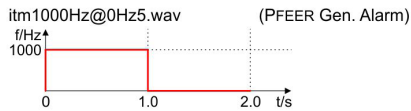

Stage 2

Rising tone 1400/1600 Hz

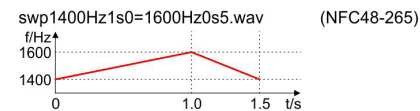

Stage 6

Intermittent 420 Hz

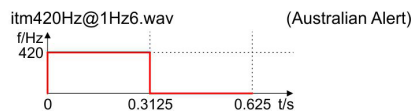

Stage 3

Constant tone 1000 Hz

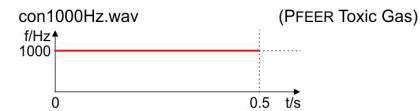

Stage 7

American Patrol

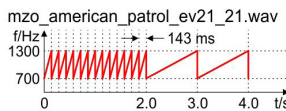

Ordering data

Type	Designation	Voltage	Start-up current	Current consumption	Art.-Nr
EV 21 Voice	Sounder	85-265 VAC/50-60 Hz	0.5 A für 5 ms	0.03 A	FHF 215 612 12
EV 21 Voice	Sounder	24 VDC -20 % +10 %	2 A ±10 % für 150 µs	0.12 A	FHF 215 612 11