

SYSTEMATIC QUALITY

Recessed-/surface mounted distributor cabinets



Catalogue



GIFAS
ELECTRIC

01A

Introduction Selection

Page 3

Introduction



Page 3

Selection



Page 3

Technical specifications

Pages 4-5

Surface mounted cabinets



Page 4

Recessed mounted cabinets



Page 5

Surface mounted distributors Stand Applications

Pages 6-12

Surface mounted distributor

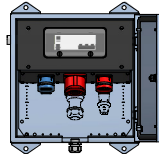

Pages 6-11

Stands

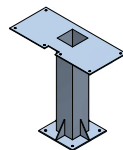

Pages 7, 9, 11

Applications



Page 12

Recessed mounted distributors Applications

Pages 13-18

Fitting options



Page 13

Recessed mounted distributors
Type with mounting frame

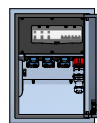

Pages 14-15

Recessed mounted distributors
Type with solid rubber enclosure

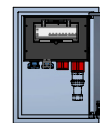

Pages 16-17

Applications



Page 18

Customised solutions

Page 19

Stainless steel A4



Page 19

With tilted roof



Page 19

Hygienic-Design

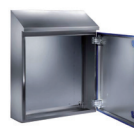

Page 19

Introduction

Thanks to GIFAS recessed- /surface mounted distributor cabinets you have access to a product range which is fulfilling highest demands. GIFAS attaches great importance on robust and stable design! In addition to our standard range we can also provide individual, customized solutions.

Benefits of our system

- optically appealing and user-oriented solutions
- can also be used with closed doors
- low-maintenance
- replaces temporary installations

Recessed- and surface mounted distributor cabinets can also be configured with water, compressed air or audio/video outlets.

Our services

- individual consultation
- proven product range
- lifetime availability of spare parts
- manufacturing from small to large series
- quote in combination with technical drawing (if required in 3D)

We use only high quality hard rubber distributor boxes and well proven components. This allows an impeccable, maintenance-free use for many years!



How do I make my selection?

The following points are important for choosing the right recessed-/ surface mounted distribution box:

1. Location, use

Will the distributor be:

- a. surface-mounted on a wall (facade)
 - Recessed mounted distributor cabinets
- b. flush-mounted in a recess in the wall
 - Surface mounted distributor cabinets
- c. mounted on a stand?

2. Material selection

For outdoor applications, we recommend a housing in a rust-free A2 (1.4301) design. For protected applications, it is sufficient to have a housing made of sheet steel, which is dip coated and powder coated. For the food and chemical industry, we also supply a V4A stainless steel housing (1.4435).

3. Dimensions

Are maximum dimensions specified for the installation location or does the cut-out already exist? What installation depth is possible for recessed mounted cabinets?

4. Configuration of electrical distributor

What power outlets are desired and with what protection? We show Applications in this brochure, which are often requested with those configurations.

5. Feed, supply line

How, or from where does the connection come - from below (usual case, see examples), above or from the back? How large is the cable cross-section (number of cable glands)?

6. Locking system

Depending on the dimensions of the housing, our power distribution boxes are equipped with 1 or 2 lock systems. A casement lock with a double bit key is used as a standard lock. This can be changed to meet your individual requests.

- three or four edge insert
- lock cylinder (KABA 5000 or your choice)
- handles made of plastic or stainless steel - with or without security cylinder

7. Type of fastening

Surface mounted housings are mounted on the wall from the outside with fixing brackets - to prevent moisture from getting in. However, there is also the possibility of mounting the housing directly from the inside (be aware of loss of seal tightness).

8. Options

- a. Rain cover: The surface distributor can additionally be equipped with a rain cover.
- b. Design for the food sector: For this purpose, housings with customized designs are used (stainless steel, IP protection, surface roughness, constructions, etc.). Also refer to page 19 for this.
- c. Ventilation nozzle: If the distributor is exposed to intense sunlight, then side-mounted ventilation nozzles are recommended.
- d. Cabinet heating: Recommended for extremely cold ambient temperatures.

Surface mounted cabinets

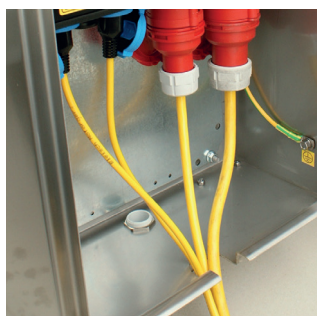

Cable outlet opening

Cable outlet openings are made project-specific depending on the number and cross-section of the cables.

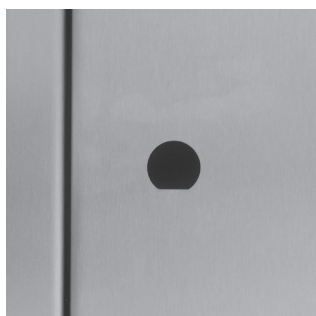

Doors

Our doors can be equipped with:

- various lock inserts
- plastic handles with/without security cylinder insert
- T-handles with/without security cylinder insert
- KABA lock cylinders
- folding lever handle for large housings



Wall-mounting brackets

Wall-mounting brackets will be attached to surface mounted boxes according to customer's request

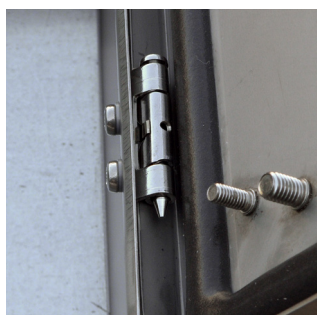

Exchangeable doors

The doors can be easily exchanged with surface mounted boxes. The banding can also be changed quickly and easily.



Ventilation

If the surface mounted boxes are exposed to the sunlight, then ventilation valves are mounted on the side of the housing in order to minimise the formation of condensate.



Hard rubber housing

- no formation of condensate
- ageing resistant
- shock resistant
- heat and cold resistant

Material thicknesses

	Housing	Doors
Surface mounted housing, sheet steel	1.38 mm	1.5 mm
Surface mounted housing, A2 rust-free	1.25 mm	1.5 mm

Stable doors

The doors on the surface mounted boxes are edged and equipped with two mounting hole strips

Technical specifications recessed mounted

Recessed mounted cabinets Type with mounting frame

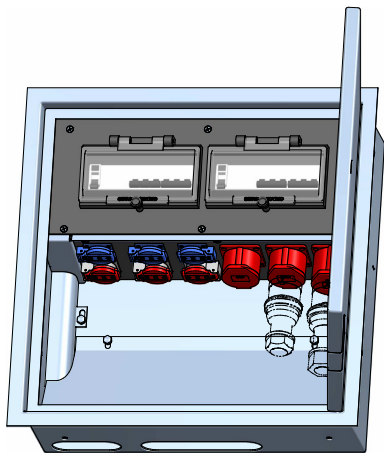

The newly developed recessed mounted boxes with mounting frame are convincing by their visually appealing and highly robust design.

Product characteristics

- stainless steel, grinded
- elegant cable outlet flap, lockable
- built-in equipment according to requirements
- feed-in cable covered
- doors can be closed when plugged-in
- slanted cover V2A inside/below
- power distribution box with PVC cover

Recessed mounted cabinets Type with solid rubber enclosure

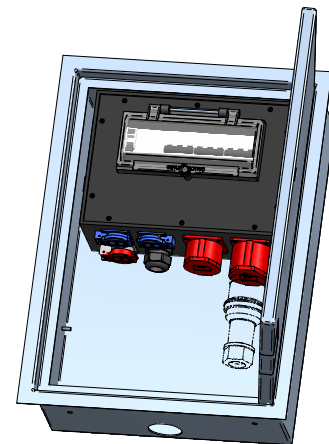

The recessed mounted cabinet with hard rubber distribution box is very robust and suited for every application

Product characteristics

- stainless steel, grinded
- elegant cable outlet flap, lockable
- built-in equipment according to requirements
- doors can be closed when plugged-in
- power distribution box made of hard rubber



Material thicknesses

	Housing	Door
Recessed mounted housing	2mm	2mm

Stable doors

The doors can be easily replaced and are mounted on robust hinges. In combination with the double-edged execution the doors are vandal-proof.

Doors

- Our doors can be equipped with:
- Casement locks
 - T-handles with/without security cylinder insert
 - KABA lock cylinders



Connection in amperes Dimensions of housing	Drawing	Configuration of outlets
<p>Type 16A max. pre-fusing.: 16A</p> <p>Housing W×H×D 300×380×210 mm</p>		<p>2×T25</p> <p>Door lock, double-bit Cable gland M20</p>
<p>Type 16A max. pre-fusing.: 40A</p> <p>Housing W×H×D 400×400×210 mm</p>		<p>1×T25 1×T23 1×CEE 16/5</p> <p>Door lock, double-bit Cable gland M25</p>
<p>Type 32A max. pre-fusing.: 63A</p> <p>Housing W×H×D 400×600×210 mm</p>		<p>1×T25 2×T23 1×CEE 16/5 1×CEE 32/5</p> <p>Door lock, double-bit Cable gland M32</p>
<p>Type 63A max. pre-fusing.: 63A</p> <p>Housing W×H×D 600×600×210 mm</p>		<p>1×T25 2×T23 1×CEE 16/5 1×CEE 32/5 1×CEE 63/5</p> <p>Door lock, double-bit Cable gland M32</p>

Surface mounted distributors V2A

Diagram		Design V2A	Mounted on stand V2A	Height of stand in mm
<p>max. pre-fusing 16A</p>		229850	229857	500
			229858	600
			229860	700
			229861	800
		229866	229869	500
			229870	600
			229871	700
			229872	800
		229879	229881	500
			229882	600
			229883	700
			229884	800
<p>max. pre-fusing 63A</p>		229891	229893	500
			229894	600
			229896	700
			229897	800

Connection in amperes Dimensions of housing	Drawing	Configuration of outlets
<p>Type 63A max. pre-fusing.: 63A</p> <p>Housing W×H×D 600×600×300 mm</p>		<p>3×T23 1×T25 1×CEE 16/5 1×CEE 32/5 1×CEE 63/5</p> <p>Door lock, double-bit Cable gland M40</p>
<p>Type 80A max. pre-fusing.: 80A</p> <p>Housing W×H×D 600×800×300 mm</p>		<p>6×T23 2×T25 2×CEE 16/5 1×CEE 32/5</p> <p>Door lock, double-bit Cable gland M40</p>
<p>Type 100A max. pre-fusing.: 100A</p> <p>Housing W×H×D 600×800×300 mm</p>		<p>3×T23 2×T25 2×CEE 16/5 2×CEE 32/5 1×CEE 63/5</p> <p>Door lock, double-bit Cable gland M50</p>

Surface mounted distributors V2A

Diagram		Design V2A	Mounted on stand V2A	Height of stand in mm								
<p>max. pre-fusing 63A 5x16mm²</p> <p>FI 63A 30mA</p> <p>FI 63A 'S' 300mA</p> <p>16A 3 32A 3 16A 1 16A 1</p> <p>T25 L1 CEE 16/5 CEE 32/5 T23 L2 T23 L3 CEE 63/5</p> <p>1 2 3 4 5</p>		229903	<table border="1"> <tr><td>230007</td><td>500</td></tr> <tr><td>230008</td><td>600</td></tr> <tr><td>230009</td><td>700</td></tr> <tr><td>230010</td><td>800</td></tr> </table>	230007	500	230008	600	230009	700	230010	800	
230007	500											
230008	600											
230009	700											
230010	800											
<p>5x25mm²</p> <p>FI 40A 30mA</p> <p>FI 63A 30mA</p> <p>16A 1 16A 1 16A 3 16A 1 16A 3 32A 3</p> <p>T23 T23 T23 T23 T25 CEE 16/5 T23 T23 T25 CEE 16/5 CEE 32/5</p>		230017	<table border="1"> <tr><td>230019</td><td>500</td></tr> <tr><td>230020</td><td>600</td></tr> <tr><td>230021</td><td>700</td></tr> <tr><td>230022</td><td>800</td></tr> </table>	230019	500	230020	600	230021	700	230022	800	
230019	500											
230020	600											
230021	700											
230022	800											
<p>5x35mm²</p> <p>FI 40A 30mA</p> <p>FI 40A 30mA</p> <p>FI 40A 30mA</p> <p>FI 63A 30mA</p> <p>16A 3 16A 3 32A 3 16A 3 32A 3 63A 3</p> <p>T23 T23 T23 T25 T25 CEE 16/5 CEE 32/5 CEE 16/5 CEE 32/5 CEE 63/5</p>		230029	<table border="1"> <tr><td>230032</td><td>500</td></tr> <tr><td>230033</td><td>600</td></tr> <tr><td>230034</td><td>700</td></tr> <tr><td>230035</td><td>800</td></tr> </table>	230032	500	230033	600	230034	700	230035	800	
230032	500											
230033	600											
230034	700											
230035	800											

Connection in amperes Dimensions of housing	Drawing	Configuration of outlets
<p>Type 32A max. pre-fusing.: 63A</p> <p>Housing W×H×D 400×600×210 mm</p>		<p>1×T25 2×T23 1×CEE 16/5 1×CEE 32/5</p> <p>Door lock, double-bit Cable gland M32</p>
<p>Type 63A max. pre-fusing.: 63A</p> <p>Housing W×H×D 600×600×300 mm</p>		<p>3×T23 1×T25 1×CEE 16/5 1×CEE 32/5 1×CEE 63/5</p> <p>Door lock, double-bit Cable gland M32</p>
<p>Type 80A max. pre-fusing.: 80A</p> <p>Housing W×H×D 600×800×300 mm</p>		<p>6×T23 2×T25 2×CEE 16/5 1×CEE 32/5</p> <p>Door lock, double-bit Cable gland M40</p>
<p>Type 100A max. pre-fusing.: 100A</p> <p>Housing W×H×D 600×800×300 mm</p>		<p>3×T23 2×T25 2×CEE 16/5 2×CEE 32/5 1×CEE 63/5</p> <p>Door lock, double-bit Cable gland M40</p>

Surface mounted distributors sheet steel

Diagram		Design sheet steel	Mounted on stand galvanised	Height of stand in mm
		236459	236699	500
			236700	600
			236701	700
			236702	800
		236463	236704	500
			236705	600
			236706	700
			236707	800
		236465	236711	500
			236712	600
			236713	700
			236714	800
		236466	236719	500
			236720	600
			236721	700
			236722	800

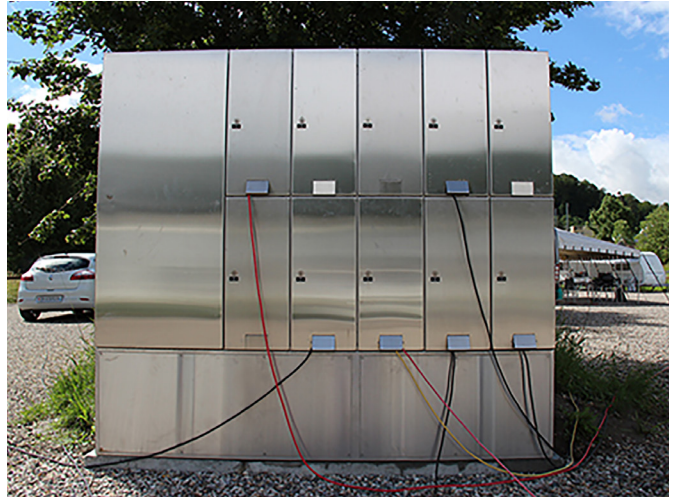

Recessed mounted box V2A Type with mounting frame

Fitting options for recessed-mounted box elegnat 400×560×220

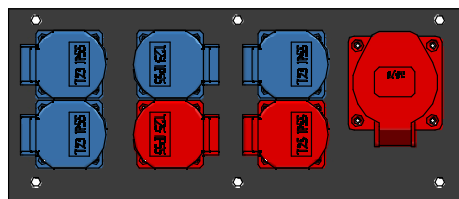
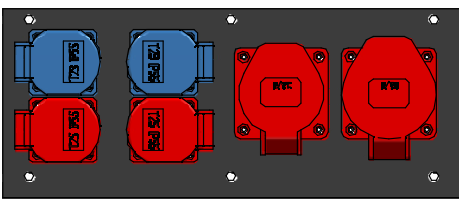
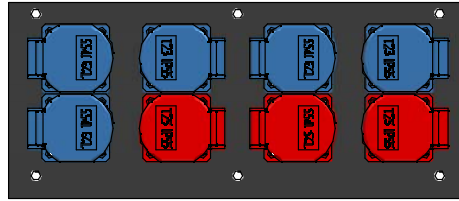
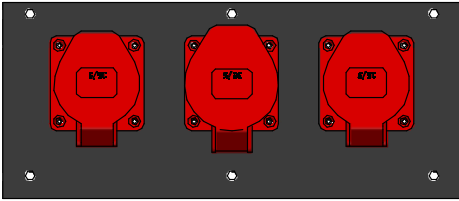

Fitting options for recessed-mounted box elegnat 560×560×220

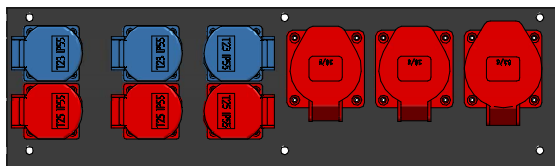
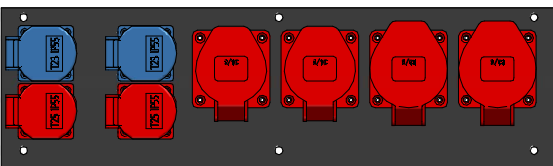
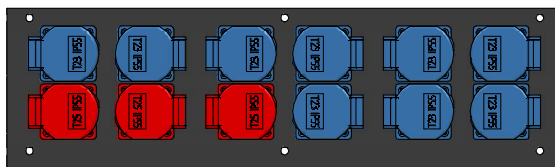
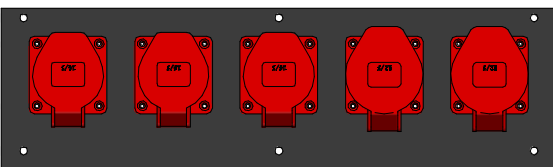

Recessed mounted distributors V2A Type with mounting frame

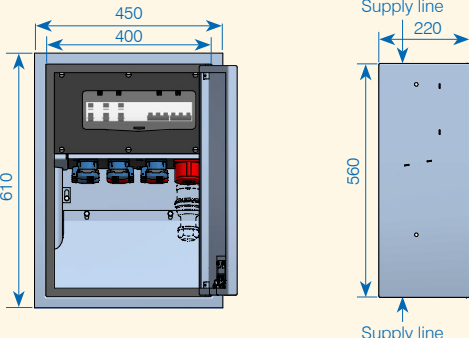
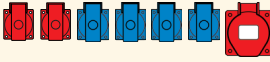
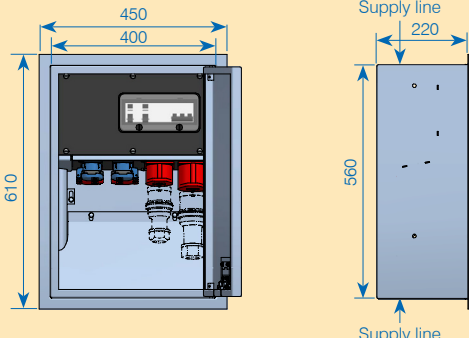
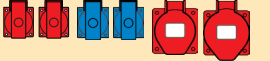
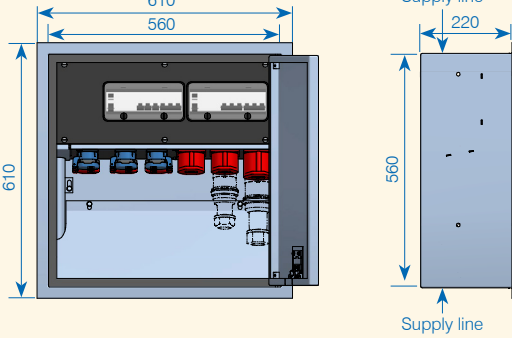
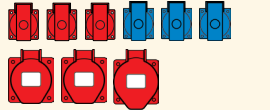
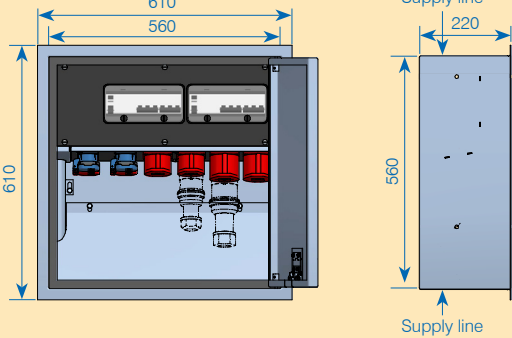
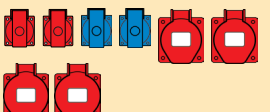



Connection in amperes Dimensions of housing	Drawing	Configuration of outlets
<p>Type 16A max. pre-fusing.: 32A</p> <p>Housing W×H×D 400×560×220 mm</p>		 <p>4×T23 2×T25 1×CEE 16/5</p>
<p>Type 32A max. pre-fusing.: 32A</p> <p>Housing W×H×D 400×560×220 mm</p>		 <p>2×T23 2×T25 1×CEE 16/5 1×CEE 32/5</p>
<p>Type 63A max. pre-fusing.: 63A</p> <p>Housing W×H×D 560×560×220 mm</p>		 <p>3×T23 3×T25 2×CEE 16/5 1×CEE 32/5</p>
<p>Type 80A max. pre-fusing.: 80A</p> <p>Housing W×H×D 560×560×220 mm</p>		 <p>2×T23 2×T25 2×CEE 16/5 2×CEE 32/5</p>

Recessed mounted distributors V2A Type with mounting frame

Diagram	Sockets	Recessed mounted box V2A complete
		<p>230134</p>
<p>max. pre-fusing 32A</p>		<p>230135</p>
		<p>230136</p>
		<p>230137</p>

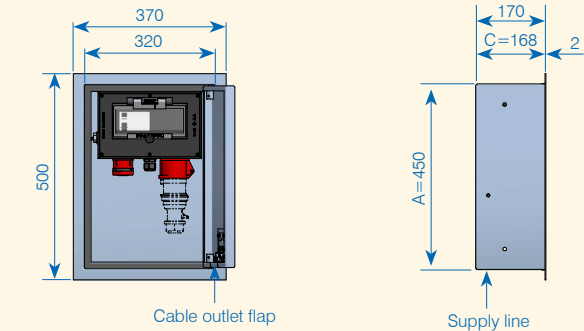
Recessed mounted distributors V2A

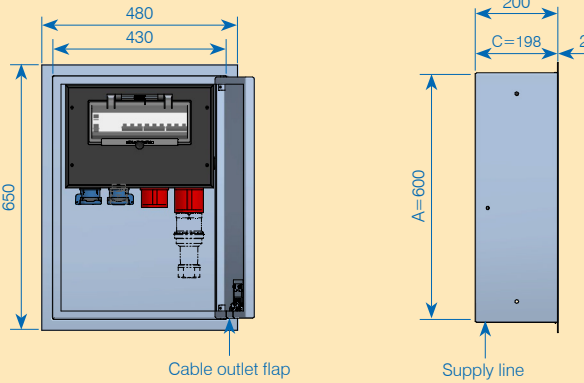
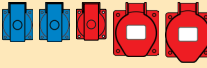
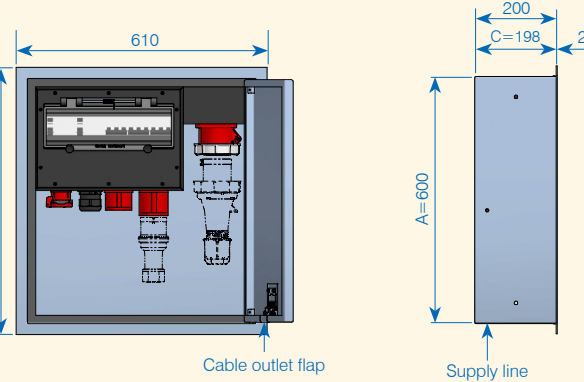
Type with solid rubber enclosure

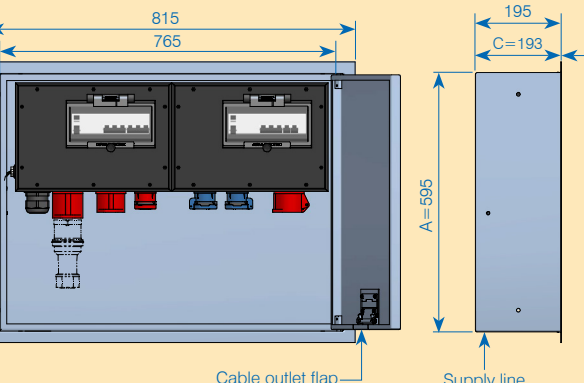
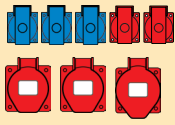
Connection in amperes Dimensions of housing	Drawing	Configuration of outlets
<p>Type 16A max. pre-fusing.: 16A</p> <p>Housing W×H×D 320×450×170 mm</p>	 <p>Cable outlet flap</p> <p>Supply line</p>	 <p>1×T25 1×CEE 16/5</p> <p>Cable gland M20</p>
<p>Type 32A max. pre-fusing.: 63A</p> <p>Housing W×H×D 430×600×200 mm</p>	 <p>Cable outlet flap</p> <p>Supply line</p>	 <p>2×T23 1×T25 1×CEE 16/5 1×CEE 32/5</p> <p>Cable gland M32</p>
<p>Type 63A max. pre-fusing.: 63A</p> <p>Housing W×H×D 560×600×200 mm</p>	 <p>Cable outlet flap</p> <p>Supply line</p>	 <p>2×T25 1×CEE 16/5 1×CEE 32/5 1×CEE 63/5</p> <p>Cable gland M40</p>
<p>Type 80A max. pre-fusing.: 100A</p> <p>Housing W×H×D 765×595×195 mm</p>	 <p>Cable outlet flap</p> <p>Supply line</p>	 <p>3×T23 2×T25 2×CEE 16/5 1×CEE 32/5</p> <p>Cable gland M40</p>

Recessed mounted distributors V2A Type with solid rubber enclosure

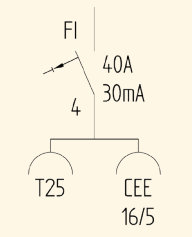
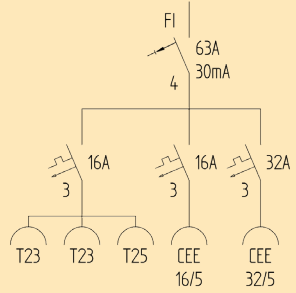
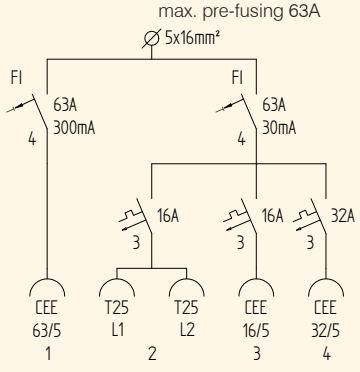
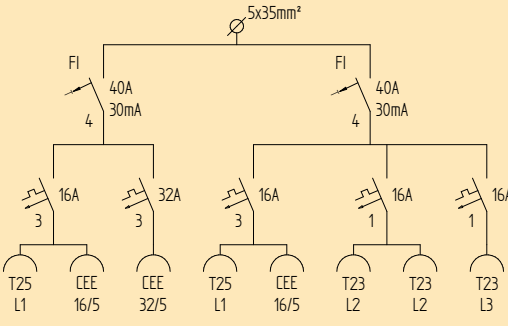
Diagram	Design	
	recessed mounted box V2A	recessed mounted frame V2A*
<p>max. pre-fusing 16A</p> 	230090	230092
	230093	230094
<p>max. pre-fusing 63A</p> <p>5x16mm²</p> 	230120	230121
<p>5x35mm²</p> 	230125	230127

*The recessed mounted frame has no back panel, the side panels are 60 or 100 mm.



On request, GIFAS-ELECTRIC will also manufacture various customised solutions described on this page.



Housing stainless steel A4 (AISI 316L)

Delivery of various housings with standard dimensions or manufacturing of customer-specific dimensions.



Housing with titled roof

Assortment on request.

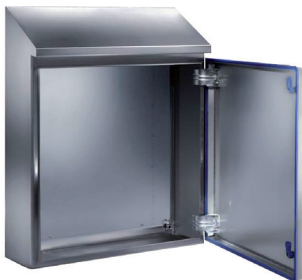

Housing in hygienic design

Housing in rust-free design A2, brush finished grain size 400, silicon seals, Lock inserts rust free, IP69 (IP69K as per DIN 40 050-9)

Assortment on request.



Cabinet with top hinges and gasskut



Cabinet with double door.

GET IN TOUCH WITH US

News about the assortment and specific solutions
you can find on our website:

www.gifas.ch



We reserve the right to make technical modifications. V 0822

GIFAS
ELECTRIC

GIFAS-ELECTRIC GmbH
Dietrichstrasse 2
CH-9424 Rheineck

+41 71 886 44 44
+41 71 886 44 49
info@gifas.ch
www.gifas.ch