

SPI WARRIOR

Linear Range - Installation Guide

This installation guide provides instructions for installing WARRIOR series of industrial linear luminaires.

Text in italics is specific for emergency variants.

Overview

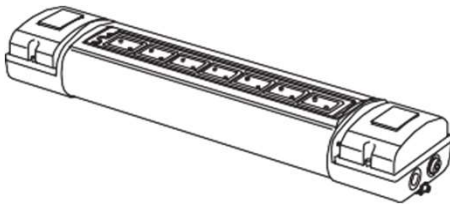

- 1 Safety Instructions
- 2 Installation
- 3 Maintenance
- 4 Technical Specification

Important information

The WARRIOR series of industrial luminaires are specialist devices, for use in specific operating environments.

The units must be installed in accordance with these instructions and must be installed by suitably qualified personnel.

If you have any queries about the installation or the certification of the unit - please contact Raytec for immediate assistance and advice.

1. Safety instructions

1. Read this leaflet carefully before commencing to install the WARRIOR unit and retain it for future use. Installation can only be carried out by suitably qualified personnel.
2. Check the certification to ensure that the, mains supply and ambient temperature present is suitable for the environment the unit is being installed in.
3. If the WARRIOR unit is to be installed in areas of high vibration, please consult with Raytec.
4. Externally the WARRIOR unit housing is constructed from marine grade aluminium and polycarbonate outer optic, stainless steel brackets/fasteners and silicone gaskets, internally there are many non metallic components. The end user must ensure that these materials are suitable for the environment the WARRIOR unit will be installed in.
5. Plastic components may be cleaned with water containing a small amount of detergent, followed by a clean water wash. Chemicals/ oils that come into contact with plastic parts may cause stress cracking and premature component failure.
5. Check certification label on cover of luminaire to ascertain type of threaded cable entry on the luminaire. Select suitably certified cable glands and stopper plugs, these must be parallel thread, have a minimum of 5 full thread engagement and be of a medium/fine tolerance to ISO965-1 and ISO965-3. The cable entry devices selected must maintain the IP rating of the luminaire
6. The incoming mains cable should not exceed a temperature rise of 27°C above the ambient conditions; select suitable cable.
7. When the unit is installed correctly and in accordance with these installation instructions it will not harm humans or animals.
8. The light source contained in this luminaire shall only be replaced by the manufacturer or his service agent or a similar qualified person.



Replace any cracked protective shield
Order SPX-BKT-RL-G2 from Raytec Ltd



Isolate mains before
removing cover



Install in a well
ventilated area

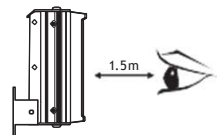

Do not continually
stare at lamp

2. Installation

Mounting WARRIOR Unit

1. To meet the requirements of certification a **MINIMUM** of 2 fixing points must be used, the fixing points must be suitable for the conditions of use. Raytec recommend using 2xM8 or 4xM6 Marine Grade A4 Stainless Steel fixings (not supplied as standard unless with accessory kits)
2. The rear of the unit has 3 blind sets of M8/M6 fixing points, a full range of mounting accessories are available including a range of pole clamps, ceiling mount brackets, various wall mount brackets, outreach bracket and chain mount eyelets. Please consult www.raytecltd.com for further details.

The spigot mount version of the product is provided with a pole mount system and 2xM8 A4 SS Grub Screws for mounting onto 32-43mm diameter poles. Once mounted tighten grub screws to 17Nm.

3. When installing the WARRIOR luminaire vertically, where possible, the cable glands should be kept to the bottom of the luminaire.

Dimensional Diagrams

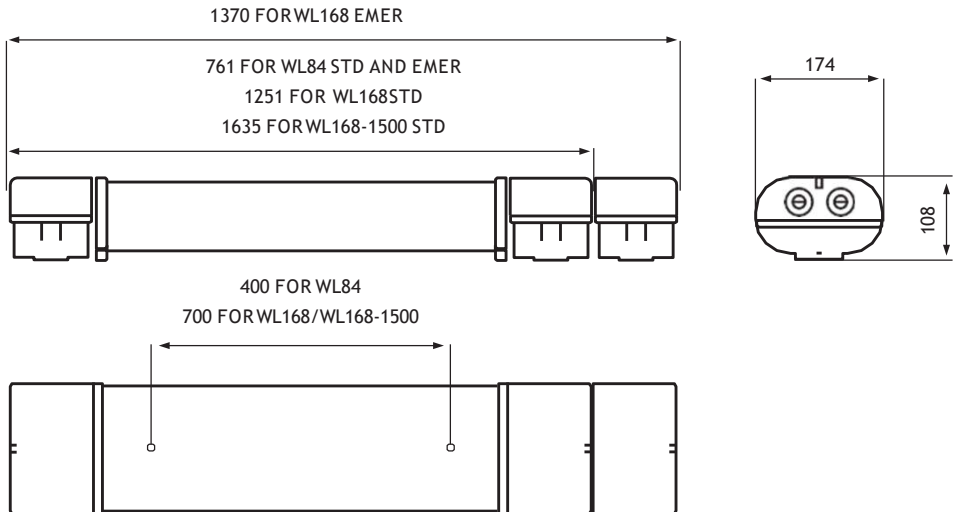

Loop In Loop Out Dimensional Diagrams

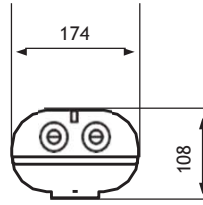
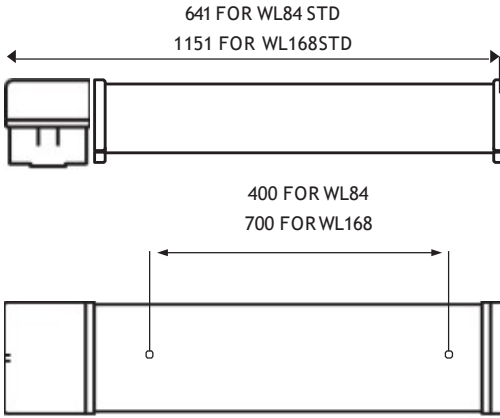

Spigot Mount Versions Dimensional Diagrams

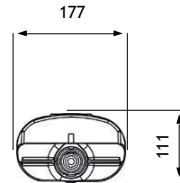
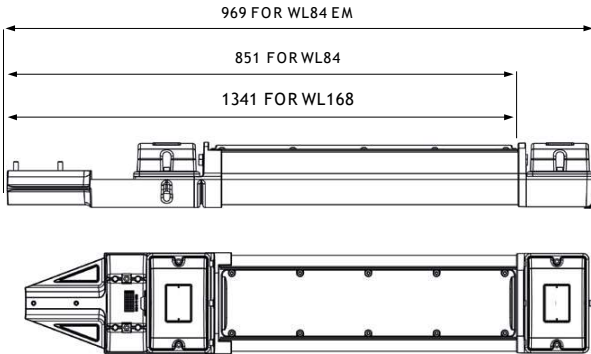

Typical wiring diagram - Standard Variants

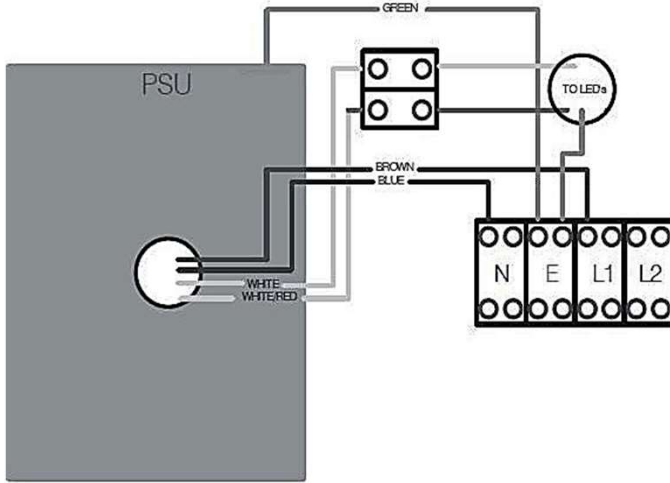

Typical wiring diagram - Emergency Variants

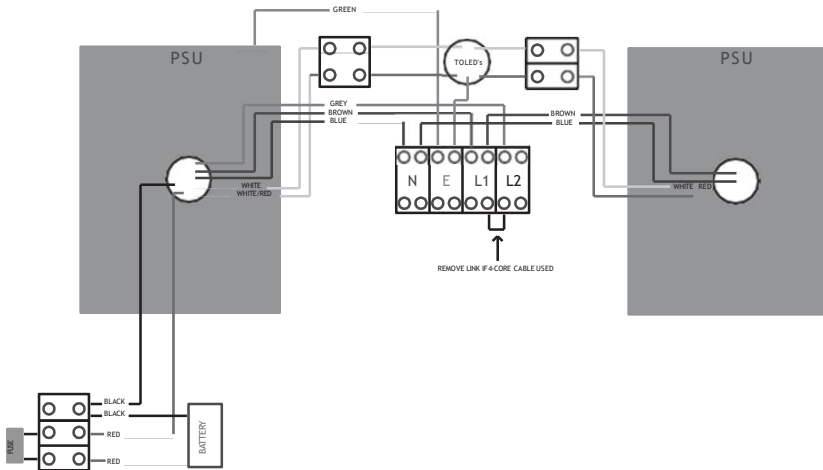

4. Open the terminal block enclosure. Wire the Mains cable into the terminal block. Provision has been made for this and identified as the E (Earth), L1 (Live switched), L2 (Live permanent) and N (Neutral) terminals. There are two pairs of contacts for each of these to facilitate a mains cable that can be looped in and out of the unit, in non LL versions an identical terminal block is also available at the other end of the luminaire to allow the unit to be through wired. The L2 terminals on a standard unit is not electrically connected but allows them to be used on the same circuits as *emergency luminaires*.
5. Installer should earth the unit separately - an internal and external earth point are provided as standard at each end of the luminaire
6. Connect wires to mains supply.
7. If the unit is opened for any reason, disconnect mains - *On emergency luminaires there may be more than one mains supply*
8. All WARRIOR luminaires have terminal blocks suitable for looping at least 4mm² cable, only one cable should be connected to each terminal block connection
9. *The battery fuse is located in the compartment that contains the battery, the fuse is disconnected after final manufacturing testing. When installing the linear the battery fuse will need to be reconnected and the unit charged for 24 hours and then discharged (repeated 3 times) to bring the battery up to peak capacity. (Unless an 'EMX' intelligent emergency variant - see notes below)*
10. *If a 4 core cable is used on emergency luminaires - L1, L2, N and E the link cable at the front of the terminal block between L1 and L2 should be removed*
11. *During emergency operation the light output and duration will be determined by the variant purchased*
12. Once wiring is complete replace terminal enclosure covers. Ensure gasket is located neatly in channel and no wires are trapped between cover and body. Tighten screws to 3Nm.

WARRIOR Intelligent Emergency Operation Guide

The light fitting will carry out the following function **automatically** after installation:

- Commissioning Cycle
- Function test
- Self-test

A tri-colour LED indicator displays the light fitting status. The indication colours are shown in table 1.

a. Commissioning Cycle

- Starts automatically after 24 hours of uninterrupted charging
- 3 charge/discharge cycles to optimise battery's full capacity.
- Battery is charged for 24 hours before each discharge cycle.
- No need for manual commissioning

b. Function Test

- Carried out every 7 days.
- Checks the function of the battery, lamp and power supply.
- Lasts for few minutes only.

c. Self-test

- Carried out at a random time every 3 month.
- Checks the battery's capacity and lamp's condition.
- Performs self-recovery for the battery if not at peak capacity.
- Is carried out at 100% load
- Discharges only 2/3 of the battery's capacity.

LED indication

LED Indication	Condition
Blinking amber	Commissioning
Static Amber	Function Test
	Self-test
Blinking Red	Battery defective/Fuse blown
	PSU error
	Battery not at peak capacity
	Light engine failure
No light	Emergency mode activated
Static Green	Battery charged and PSU OK

Notes

- The luminaire will switch off momentarily (<0.5sec) during the transition between a test and normal operation.

If a test was interrupted by a mains failure, the test will be halted, and the unit will enter emergency mode. Once the mains supply is back, the unit will allow 24 hours to recharge the battery before continuing the tests.

The self-test is carried out at a random time to eliminate the possibility of having more than one unit undergoing the test at the same time.

4. Technical Specification

	WL84-STD	WL84-EM	WL168-STD	WL168-EM
Input Voltage	110-254V AC			
Input Current (230Vac, full load)	0.15A		0.3A	
Consumption	24W STD	32W EM	49W STD	56W EM
Power Factor (230Vac, fullload)	>0.95			
Mains Frequency	50/60Hz			
Inrush Current (I_{peak} @50%)	20A, $\Delta t < 300\mu s$		28A, $\Delta t < 300\mu s$	
Total Harmonic Distortion (230Vac, full load)	< 10%			
IP Rating	IP66/67			
Weight (std)	6Kg	7Kg	9Kg	10Kg
Dimensions	See previous pages for linediagrams			
Ambient Range	-40°C to +60°C -20°C to +50°C (EM versions)			

Inrush Current Typical Curve

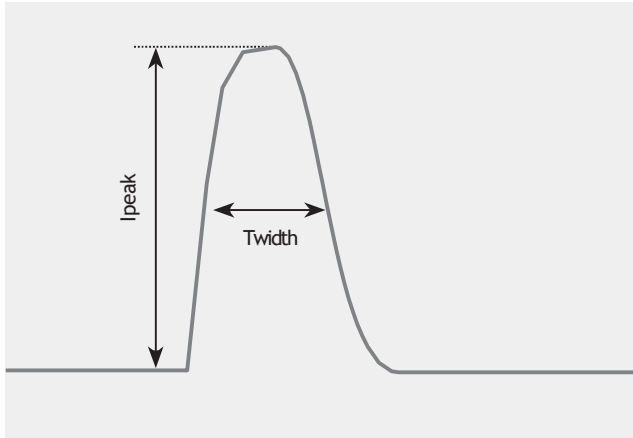

Max number of fittings allowed per MCB
(Based on 230V)

MCB Type	Rating	SPI WL84 STD	SPI-WL84 EM	SPI-WL168 STD	SPI-WL168 EM
B	10A	11	10	5	4
B	16A	17	15	8	7
B	20A	25	22	12	11
B	25A	35	32	16	15
C	10A	24	20	11	10
C	16A	34	28	16	15
C	20A	49	44	23	20
C	25A	58	55	28	25



rayTEC[®]

UK /Europe

T: +44 (0) 01670520055

hazsales@rayteclcd.com

Americas

T: +1 613 2709990

ushazsales@rayteclcd.com

www.rayteclcd.com