

Micropoint 2

IP20 

- Product luminaires comply with EN60598-2-22 and are suitable for use in normal interior conditions.
- This luminaire has an ambient temperature range of 5°C to 25°C
- Once installed in the ceiling, the luminaire face is rated IP44
- The change in mode of operation from mains to emergency is automatically changed to emergency by the integral pc board gear

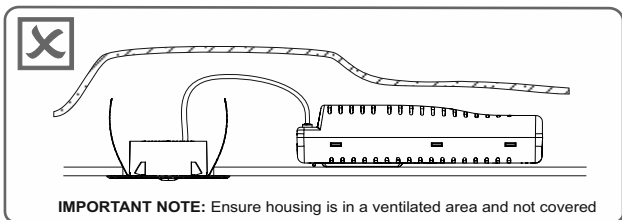
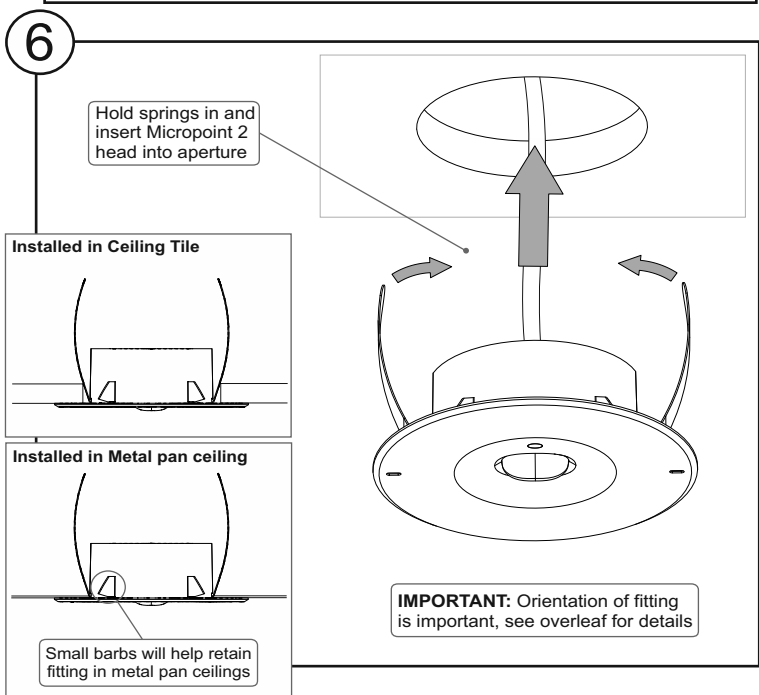
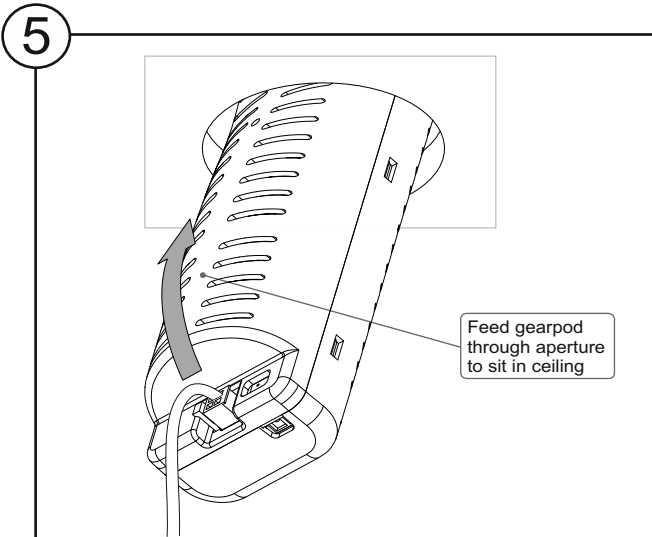
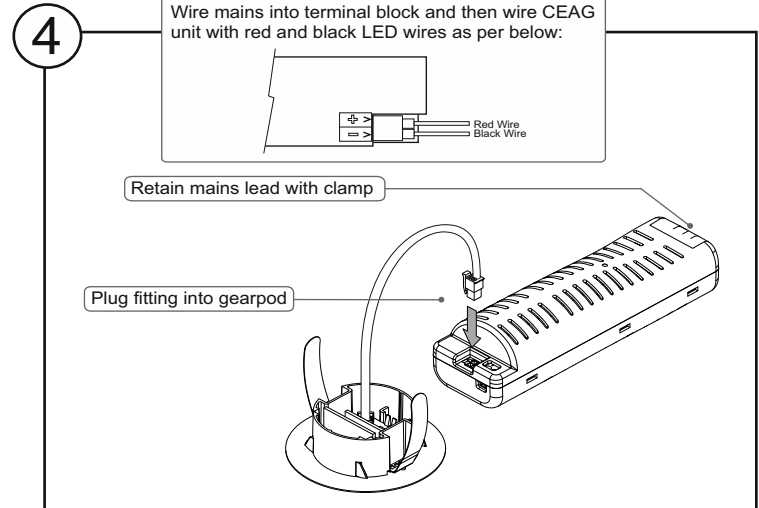
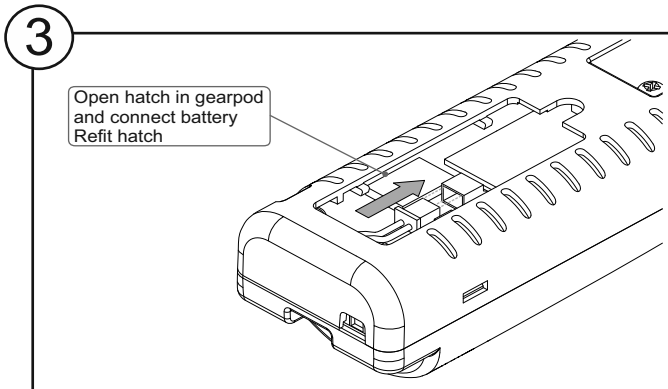
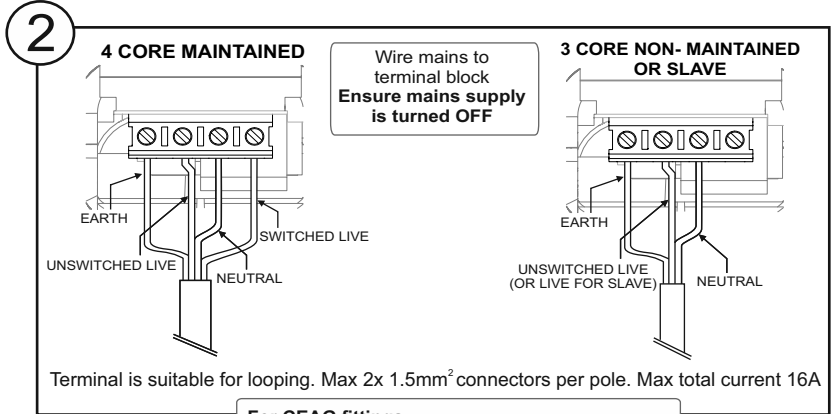
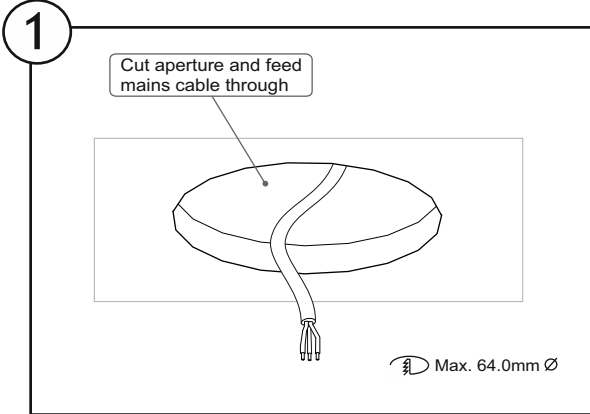

IMPORTANT NOTE:

Ensure that indents on the fascia run parallel to the longest wall & or ceiling system.
This will provide optimum illuminance on the floor due to the rectangular light distribution

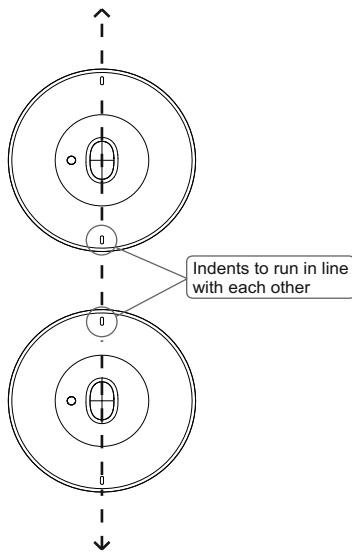

Escape Route Light Distribution

For escape route, ensure indents run along parallel with the longest edge

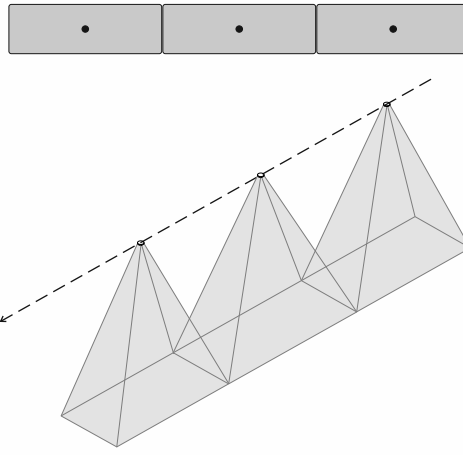

Open Area Light Distribution

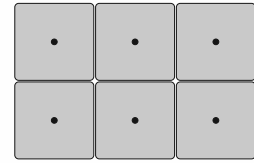

Touch-Sense Instructions (Not available on slave variants)

Touch-sense control can be used to start manual emergency tests or to adjust the mains light level. Touch-sense is activated by moving a finger rapidly over the sensor region around the green charge LED until the green LED starts to flash rapidly.

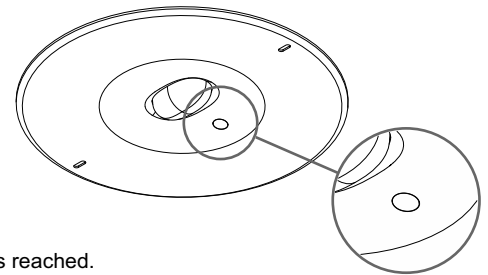

A **short activation** (about 0.5 second) starts a 10-second emergency test.

A **long activation** (greater than 3 seconds) changes the mains LED light level to the next level 'setting' which is then saved to memory. There are 5 possible mains light level settings:

Off **Low** **Medium** **High** **Full**

After each light level change, remove your finger and re-activate. Repeat until the desired setting is reached.

Luminaire Cleaning

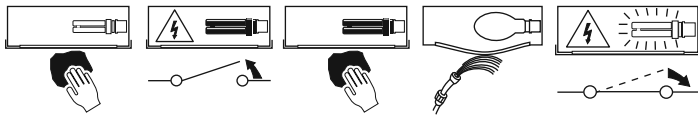

End of Life and Components Disposal

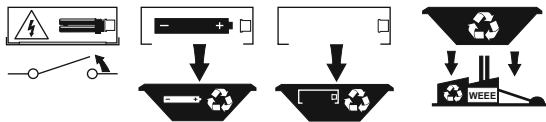

IMPORTANT NOTE for installation near metalwork

Installation of the luminaire in metal pan ceilings or in close proximity to metalwork may cause disruption to the touch sense control. In this case touch sense may be disabled using the jumper link as shown. Touch sense can be re-enabled at any time to facilitate setting changes or 10 sec emergency tests by reconnecting the jumper. All other operations remain unchanged.

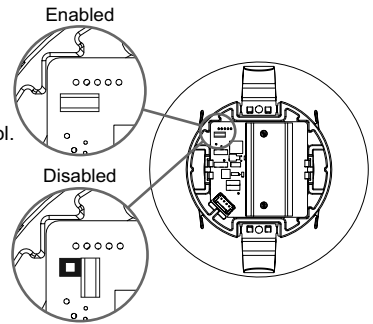

Safe Operation

1. Check the rating label for voltage and frequency before connecting this luminaire to the electrical supply.
2. Ensure that the mains supply is switched off when working on this luminaire, whether installing or carrying out any other servicing.
3. To prevent damage to driver, do not mix with conventional magnetic ballasts on the same electrical circuit.
4. Where use in more onerous situations is required, e.g. In part-completed buildings before "drying-out" is completed, or areas where ambient temperatures are outside the normal temperature range, then consult our Sales Office.
5. This product must only be installed in locations where accidental disconnection of the head interconnection lead is not possible.

Servicing and Disposal

1. At commissioning and handing over of installation ensure that a copy of these instructions is presented to the authority responsible for the operation and maintenance of the luminaires.
2. Servicing, e.g. cleaning, must only be carried out after the electricity supply has been switched off. It must not be assumed that luminaires with lamps not lit are switched off-always check before servicing.
3. Cleaning should be carried out at regular intervals to ensure that dirt does not accumulate to an extent that will impair the thermal safety or optical performance of the luminaire. Regular cleaning will also ensure that the optical performance of the luminaires is maintained.
4. Avoid touching the LED array surface. To clean - Blow surface with either dry air or nitrogen gas.
5. At the end of life the luminaire is classed as WEEE under directive 2012/19/EU and should be disposed of in accordance with local legislation.

Note: The LED's are non-replaceable but the batteries can be replaced by a competent person