

# Control switch, GHG 292 and control switch with measuring instrument, GHG 293

Dimensions in mm  
X = fixing dimensions

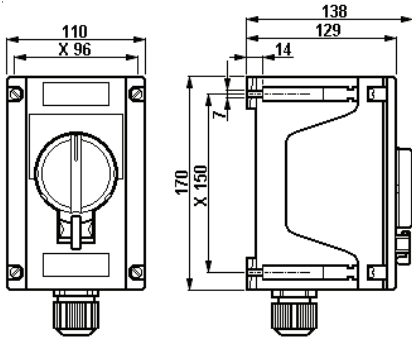

Control switch GHG 292

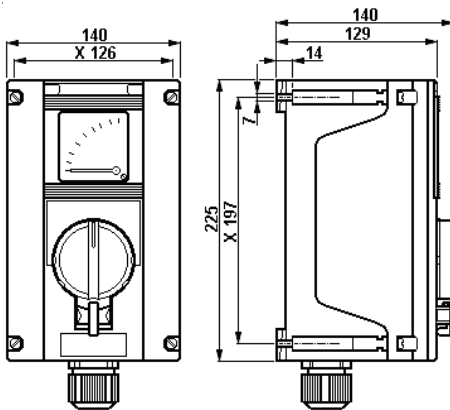

Control switch GHG 293,  
with meas. instrument with c.t. connection

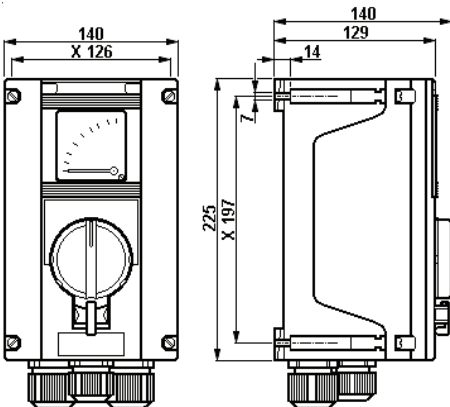

Control switch GHG 293,  
with mes. instrument with direct  
connection

## 1 Technical data

### 1.1 Control switch GHG 29.

Marking acc. to 94/9/EC:	⊕ II 2 G Ex d e ia II C T5/T6		
	⊕ II 2 D Ex tD A21 IP66 T80 °C		
EC type examination certificate:	complete		
	PTB 99 ATEX 1163		
switch base Ex 29	PTB 98 ATEX 1118 U		
switch base Ex 28	PTB 98 ATEX 1117 U		
Rated voltage Ex 29:	up to 500V, 50/60 Hz		
Rated voltage Ex 28:	up to 690V, 50/60 Hz		
Rated current Ex 29:	up to 16 A*		
	* with rated current $\geq 12A$		
	terminal cross section $\geq 2.5mm^2$ .		
Rated current Ex 28:	up to 20 A		
Permissible ambient temperature:	-20° C up to +40° C (standard version)		
Other temperatures possible with special versions.			
Perm.ambient temperature in original packing:	-50° C to +80° C		
Perm. short-circuit back-up fuse:	20 A/gL at 500V		
Switching capacity Ex 29:	AC 15	230V / 6 A	400V / 4.0 A
	DC 13	24V / 2 A	230V / 0.3 A
Switching capacity Ex 28:	AC 15	230V / 8 A	500V / 6.0 A
	DC 13	24V / 6 A	230V / 0.4 A
Design with gold-tipped contacts:			
Rated voltage	24 V		
Rated current	max. 400 mA		
Degree of protection to EN/IEC 60529:	IP 66 (standard version)		
Insulation class acc. to EN/IEC 61140:	I - plastic terminal boxes fulfil this requirement		
	II - with metal flange		
Cable entries:			
	(standard version)		
GHG 292	1 x M25 for cable $\varnothing$ 8 - 17 mm		
GHG 293 with c.t. measuring instrument	1 x M32 for cable $\varnothing$ 12 - 21 mm		
GHG 293 with directly indicated meas. instrument	2 x M32 and 1 x M25		
Terminals (standard version):	2 x 0.5 - 2.5 mm <sup>2</sup> or 1 x 1.0 - 6.0 mm <sup>2</sup>		
Test torques:			
Cap nut of the cable entry M 25	3.5 Nm		
Cap nut of the cable entry M 32	5.0 Nm		
Cover screws	2.5 Nm		
Terminals	2.5 Nm		
Weight:	1 level	2 levels	3 levels
standard version GHG 292	approx. 1.10 kg	1.25 kg	1.40 kg
standard version GHG 293 (c.t.)	approx. 2.00 kg	2.15 kg	2.30 kg
standard version GHG 293 (direct)	approx. 2.15 kg	2.30 kg	2.45 kg

### 1.2 AM72 measuring instrument:

EC type examination certificate:	PTB 99 ATEX 2032 U	
Movement:	Moving iron Ex e	Moving coil Ex ib II C
Measuring accuracy:	Class 2.5	Class 1.5
Overload range:	10-fold at 25 sec.	10-fold at 5 sec.
	25-fold at 4 sec.	
	50-fold at 1 sec.	
	telltale 1:1.5	
Measuring range:	n / 1 A	0 - 20 mA
	0 - 25 A direct	4 - 20 mA
L <sub>i</sub> :	-	max. 0.1 mH
C <sub>i</sub> :	-	max. 0.1 nF
U <sub>i</sub> :	-	max. 30 V
I <sub>i</sub> :	-	max. 150 mA
Terminals:	2 x 1.5 - 4 mm <sup>2</sup>	
AM 72 weight:	approx. 0.40 kg	
Max. safe voltage U <sub>m</sub> :	690 V <sub>eff</sub>	
	Safe galvanic isolation from all other circuits and earth	

### 1.3 Intrinsically safe switch circuits:

Max. safe voltage U <sub>m</sub> :	690 V <sub>eff</sub>
	Safe galvanic isolation from all other circuits and earth

# Control switch, GHG 292 and control switch with measuring instrument, GHG 293

Contact arrangement  
EX 29 control switch

Circuitry  
Code

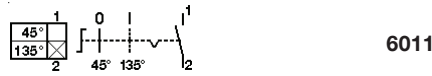

6011

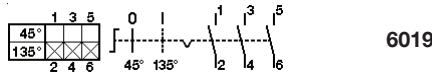

6019

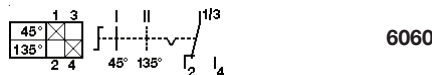

6060

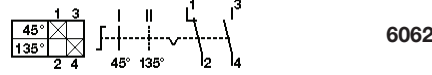

6062

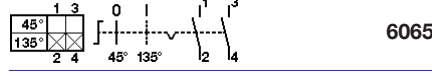

6065

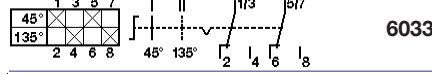

6033

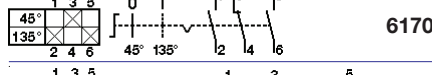

6170

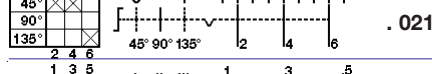

.021

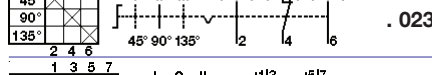

.023

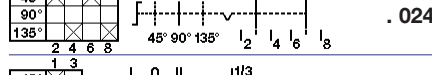

.024

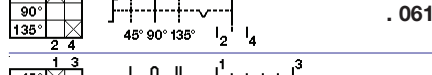

.061

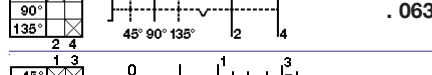

.063

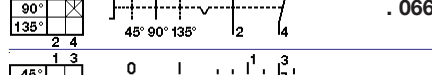

.066

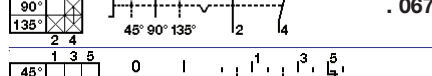

.067

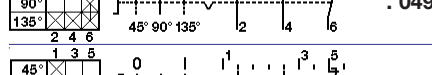

.049

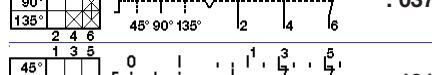

.037

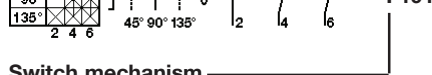

.191

Switch mechanism

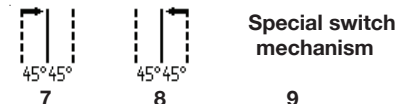
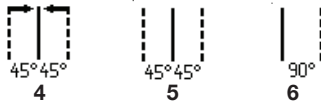

Special switch  
mechanism

9

## 2 Safety instructions



*The control switches are not suited for use in Zone 0.*

*The temperature class and type of protection stated on the apparatus shall be observed.*

*Modifications or changes to the control switches are not permitted.*

*They shall be used for their intended purpose and shall be in a perfect and clean state.*

*The requirements of the EN 61241-0 and -1 regarding excessive dust deposits and temperature to be considered from the user.*

*Only original CCH / CEAG parts may be used as replacements and for repairs. Repairs that affect the explosion protection may only be carried out by CCH / CEAG or by a qualified electrician in compliance with the respective national regulations.*

*Prior to being put into operation, the control switches shall be checked in accordance with the instructions as per section 6.*

*Before initial operation, any foreign matter shall be removed from the apparatus.*

**Warning:**  
*Observe the minimum terminal cross sections of the control switches according to the rated currents (see Technical data, page 8)*

*The national safety rules and regulations for the prevention of accidents, as well as the safety instructions included in these operating instructions, that, like this text, are set in italics, shall be observed!*

## 3 Conformity with standards

The apparatus conforms to the standards specified in the EC-Declaration of conformity, enclosed separately.

It has been designed, manufactured and tested according to the state of the art and to DIN EN ISO 9001.

94/9 EC: Equipment and protective systems intended for use in potentially explosive atmospheres.

The control switches fulfil further requirements, such as those of the EC directive on electromagnetic compatibility (2004/108/EG).

## 4 Field of application

The control switches are intended for use in potentially explosive atmospheres in zones 1 and zones 2 as well as in zones 21 and zones 22 in accordance with EN 60079-10!

The enclosure materials used, including any external metal parts, are high quality materials that ensure a corrosion resistance and resistance to chemical substances according to the requirements for use in a "normal industrial atmosphere":

- glass-fibre reinforced polyester
- impact resistant polyamide
- special steel AISI 316 L

In case of use in an extremely aggressive atmosphere, please refer to manufacturer.

## 5 Application / Properties

The control switches are used for the local switching of electric drives in potentially explosive gas atmospheres.

The design of the switch contact block (with max. 3 levels = 6 contacts) is dependent upon the respective application.

Details relating to the electric contacts can be found on the switch contact block.

Specially marked special versions of the control units can be used in "intrinsically safe circuits".

**The electrical limiting values that are decisive for the intrinsic safety shall be observed.**

The version with gold-tipped contacts is suited for switching extra-low voltage circuits. Special attention shall be paid to the maximum current load (see technical data, page 8). The contact chamber of the gold-tipped version is marked with the letter "G" or colour-coded.

To ensure a safe and reliable disconnection, compulsory opening contacts are standard.

A safe and reliable closing of the special contact is achieved by a special version of the compulsory closing contact. The contact chamber of the compulsory closing contact is marked with the letter "Z" or it is also colour-coded.

The measuring instruments are used to indicate the pick-up current of the respective electrical apparatus (single phase). See "Technical Data" for details of measuring mechanism, accuracy and connection.

# Control switch, GHG 292 and control switch with measuring instrument, GHG 293

With measuring instruments for c.t. connection, the pick-up current is indicated indirectly, with direct indication instruments it is indicated directly.

Control switches with direct-indicating measuring instruments are fitted with looping terminals for looping the PE conductor and phases not fed via the measuring instrument (see technical data for temperature class, explosion group and permissible ambient temperature).

The control switches are generally fitted with a locking facility and can be locked in the OFF or left position by means of a padlock to prevent unauthorized switching (shackle diameter of padlocks up to 5 mm see fig. A).

**Other locking positions can be set according to separate conversion instructions.**

**The data according to sections 3 and 4 shall be taken into account during use.**

**Applications other than those described are not permissible without a written declaration of consent from Messrs. CCH / CEAG.**

**During operation the instructions stated in section 7 of the operating instructions shall be observed.**

**The sole responsibility with respect to the suitability and proper use of the control switches with regard to the basic requirements of these instructions (see technical data) lies with the operator.**

## 6 Installation

The relevant national regulations( and the generally recognized rules of engineering apply for the installation and operation.

**The improper installation and operation of control switches may result in the invalidation of the guarantee.**

## 6.1 Mounting

The control switches can be mounted without opening the enclosure.

When the control switches are mounted directly onto the wall, they shall rest evenly only on the fastening points provided for this purpose.

The screw chosen shall fit the fixing hole (see dimensional drawing) and shall not damage the hole (e.g. use of a washer).

The apparatus shall be fixed diagonally with a minimum of 2 screws.

**If the screws are overtightened, the apparatus may be damaged.**

The control switches are suited for plug-in mounting on CCH / CEAG apparatus holders, sizes 2 and 2A for switches of the type GHG 292 and size 3 for switches with measuring instruments of the type GHG 293, whereby they are pushed into the guide groove from the top of the apparatus holder.

See the respective mounting instructions.

Fig. A

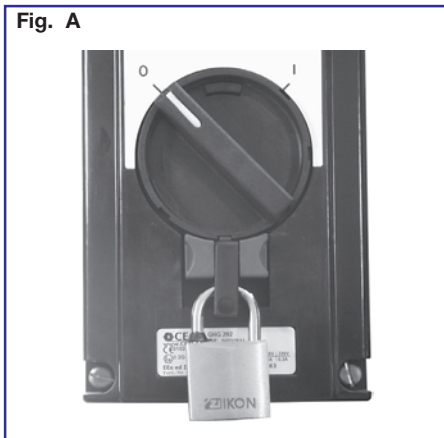

Apparatus holder size 2

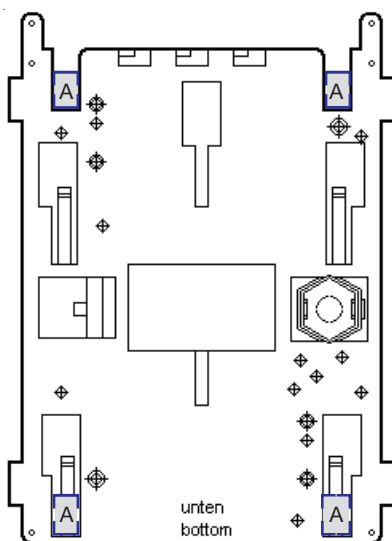

A = fixing point for control switches GHG 292

Apparatus holder size 3 for pipe fixing

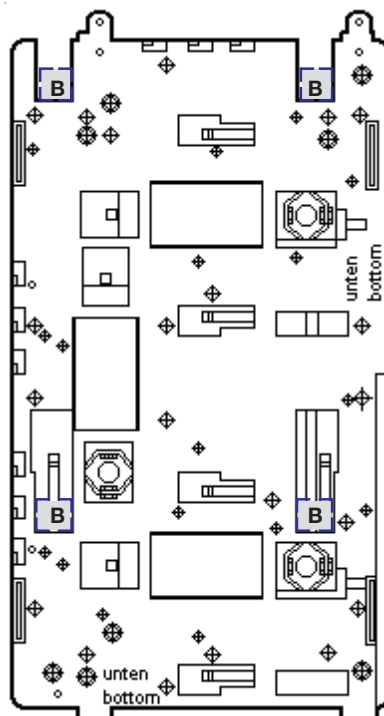

B = fixing point for control switches GHG 293

Apparatus holder size 3 for wal- and trellis fixing

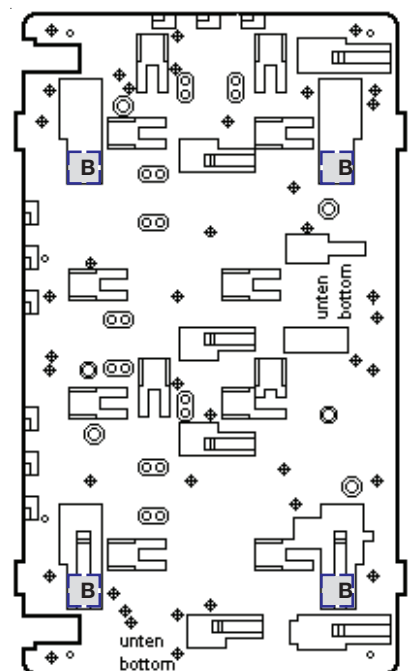

# Control switch, GHG 292 and control switch with measuring instrument, GHG 293

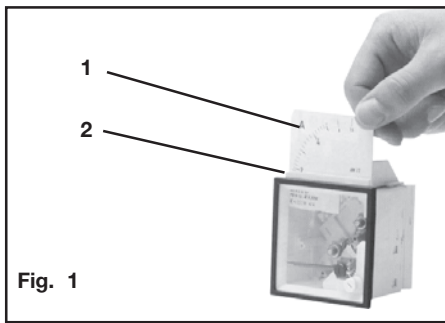

Fig. 1

## 6.2 Opening apparatus / Electrical connection

**Before opening the apparatus, it is necessary to ensure that there is no voltage or to take suitable protective measures.**

**The electrical connection of the may only be carried out by specialists.**

The properly bared conductors of cables shall be connected with due regard to the respective regulations.

**To maintain the explosion protection, conductors shall be connected with special care.**

**The insulation shall reach up to the terminal. The conductor itself shall not be damaged.**

**The minimum and maximum conductor cross sections that can be connected shall be observed (see technical data).**

**In the case of mixed Ex-e / Ex-i installations, the required minimum clearances shall be maintained (see, for example, EN 60 079-11).**

**When apparatus is open, it is necessary to ensure (disconnect voltage supply) that no voltage is carried over into the connected intrinsically safe circuits.**

All screws and/or nuts of connection terminals, including those not in use, shall be tightened down securely.

**Excessive tightening may affect or damage the connection.**

The terminals are designed for the direct connection of conductors with copper wires. If multi- or fine-wire connecting cables are used, the wire ends shall be handled according to the applicable national and international regulations (e.g. use of multicore cable ends).

The position of the terminals can be found in the connection diagram or the diagram showing the contact arrangement of the switch insert on page 8.

With measuring instruments for c.t. connection n/1A (Fig. 1) the interchangeable scale, item 1, can be exchanged via a flap, item 2, on the upper part of the measuring instrument.

To ensure a correct closing of the manual motor starter, switching at the switch shaft of the switch insert when the apparatus is open is not permitted.

If, to facilitate the feeding of conductors into the enclosure, the switch insert is snapped out of the rail on the enclosure base by releasing the catches (top or bottom on insert), it shall be snapped back properly into the same notch in the enclosure base before the electrical connection. When fitting the apparatus cover, care shall be taken to ensure that the switch shaft of the switch insert engages correctly in the carrier hole of the switch handle (pay attention to the correct position of the switch handle).

## 6.3 Cable entries (KLE); blanking plugs

**Generally only certified cable entries and blanking plugs may be used. Flexible cables shall be used with trumpet-shaped cable glands or other suitable entries with additional pull relief.**

When using cable entries with a degree of protection that is lower than the IP protection of the apparatus (see page 8), the degree of IP protection for the complete unit is reduced.

**The relevant mounting directives for cables entries being used shall be observed.**

In order to ensure the minimum degree of protection, any unused entry holes shall be sealed with certified blanking plugs.

When fitting cable entries, care has to be taken that the sealing inserts are suitable for the cable diameter.

In the case of sealing inserts that are cut out, it is necessary to ensure that the insert is properly adapted to the cable diameter.

Intrinsically safe circuits shall be fed through cable entries that are colour-coded (light blue).

In order to ensure the required minimum degree of protection, the cable entries shall be tightened down securely.

**Overtightening can impair the degree of protection.**

**Warning: When tightening the cap nut of the metal cable entry (e.g. type ADE 1F), a suitable tool shall be used to safeguard the gland against twisting.**

Any unused metric CCH / CEAG cable entries shall be sealed with the blanking plug certified for these metric cable entries.

# Control switch, GHG 292 and control switch with measuring instrument, GHG 293

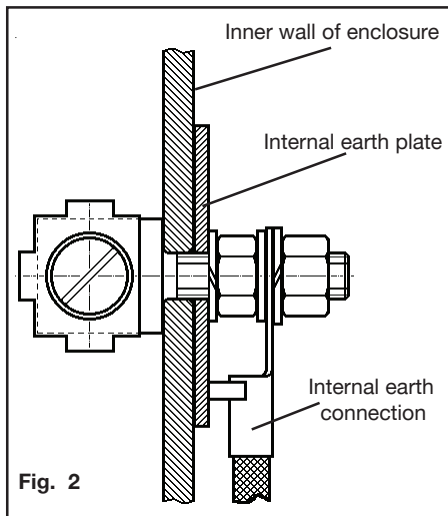

Fig. 2

**When fitting the apparatus cover, care shall be taken to ensure that the switch shaft of the switch insert engages correctly in the carrier hole of the switch handle.**

To ensure the required minimum degree of protection, the cover screws shall be tightened down.

**Overtightening may impair the degree of protection.**

## 6.6 Putting into operation

Before putting the apparatus into operation, the tests specified in the individual national regulations shall be performed.

In addition to this, before being put into operation, the correct functioning of the apparatus and installation of the apparatus shall be checked in accordance with these operating instructions and other applicable regulations.

The zero setting of the measuring instrument needle shall be checked before putting it into operation. If necessary, the measuring instrument needle shall be set to zero using the adjustment screw.

The gas group (IIB or IIC) of the intrinsically safe circuit shall be taken into consideration for the evaluation of the gas group of the built-in components.

**If intrinsically safe circuits are switched or fed in the control switches, the limiting electrical values that are decisive for the „Intrinsic Safety“ shall be observed.**

**The improper operation of control switches may result in the invalidation of the guarantee.**

Working with live circuits is permissible for intrinsically safe circuits.

The necessary intervals between servicing depend upon the specific application and shall be stipulated by the operator according to the respective operating conditions.

During servicing, above all, the parts on which the explosion protection depend, (e.g. intactness of the flameproof components, the enclosure, the seals and cable entries), and the switch mechanism function of the control switch shall be checked.

If, in the course of servicing, it is ascertained, that repairs are necessary, section 8 of these operating instructions shall be observed.

## 6.4 Flange\* and metal plates and external earth connection

If flange plates have to be dismantled, (e.g. to drill entry holes), when replacing the plates, in order to maintain the minimum degree of protection, it is necessary to ensure that the flange plate and the fixing clamp fit correctly.

**PE conductors fed from outside shall be connected to the PE terminal provided on the flange.**

In case an external earth connection is mounted on the plastic enclosure, it should be connected with a max. 25mm<sup>2</sup> wire.

This earth connection is inserted through a M6 drill in the inner wall of the enclosure (see fig. 2).

**Warning: Metal flanges, metal plates and metal glands shall be incorporated in the potential equalization.**

\* not yet certified for category II D

## 6.5 Closing apparatus

**Any foreign matter shall be removed from the apparatus.**

The switch handle on the cover of the manual motor starter shall be in the position it had when the apparatus was opened.

## 7 Maintenance / Servicing

**The valid national regulations for the servicing / maintenance of electrical apparatus for use in potentially explosive atmospheres shall be observed (EN 60079-17).**

**Prior to opening the enclosure, it is necessary to ensure that the voltage supply has been isolated or to take suitable protective measures.**

## 8 Repairs / Overhaul / Modifications

Only original CCH / CEAG parts shall be used for carrying out repairs.

**In the event of damage to the flameproof encapsulation, replacement of these components is mandatory. In case of doubt, the respective apparatus shall be sent to CCH / CEAG for repair.**

**Repairs that affect the explosion protection may only be carried out by CCH / CEAG or by a qualified electrician in compliance with the respective national regulations. (EN 60079-19)**

Apparatus modifications or design changes are not permitted; excepted from this are the fitting of additional cable entries within the scope of the apparatus approvals and the adjustment of the locking position in accordance with separate conversion instructions (obtainable from manufacturer).

## 9 Disposal / Recycling

The respective valid national regulations for waste disposal shall be observed when disposing of apparatus.

To facilitate recycling of individual parts, parts made of moulded plastic shall bear the marking for the type of plastic used.

The product range is subject to changes and additions.